

Xantrex™ XW Power System

Xantrex XW4024 120/240 60

Xantrex XW4548 120/240 60

Xantrex XW6048 120/240 60

Installation Guide



The logo for Soligent features the word "Soligent" in a bold, blue, sans-serif font. A thick, yellow-orange arc curves over the top of the letters "o" and "l", extending from the top of the "o" to the top of the "l".

Soligent

YOUR SCHNEIDER ELECTRIC DISTRIBUTOR
SOLIGENT
800-967-6917
www.soligent.net

Xantrex XW Power System

Installation Guide

Trademarks

Schneider Electric, the **Schneider Electric logo**, **Xantrex**, and **Xanbus** are trademarks or registered trademarks of the Schneider Electric group of companies. Other trademarks, registered trademarks, and product names are the property of their respective owners and are used herein for identification purposes only.

Notice of Copyright

Copyright © 2007, 2008, 2010 Xantrex Technology Inc. All rights reserved. No part of this document may be reproduced in any form or disclosed to third parties without the express written consent of:

Xantrex Technology Inc.

161-G South Vasco Road

Livermore, California USA 94551

Xantrex Technology Inc. reserves the right to revise this document and to periodically make changes to the content hereof without obligation or organization of such revisions or changes unless required to do so by prior arrangement.

Exclusion for Documentation

UNLESS SPECIFICALLY AGREED TO IN WRITING, XANTREX TECHNOLOGY INC. ("XANTREX")

(A) MAKES NO WARRANTY AS TO THE ACCURACY, SUFFICIENCY OR SUITABILITY OF ANY TECHNICAL OR OTHER INFORMATION PROVIDED IN ITS MANUALS OR OTHER DOCUMENTATION;

(B) ASSUMES NO RESPONSIBILITY OR LIABILITY FOR LOSSES, DAMAGES, COSTS OR EXPENSES, WHETHER SPECIAL, DIRECT, INDIRECT, CONSEQUENTIAL OR INCIDENTAL, WHICH MIGHT ARISE OUT OF THE USE OF SUCH INFORMATION. THE USE OF ANY SUCH INFORMATION WILL BE ENTIRELY AT THE USER'S RISK; AND

(C) REMINDS YOU THAT IF THIS MANUAL IS IN ANY LANGUAGE OTHER THAN ENGLISH, ALTHOUGH STEPS HAVE BEEN TAKEN TO MAINTAIN THE ACCURACY OF THE TRANSLATION, THE ACCURACY CANNOT BE GUARANTEED. APPROVED XANTREX CONTENT IS CONTAINED WITH THE ENGLISH LANGUAGE VERSION WHICH IS POSTED AT WWW.SCHNEIDER-ELECTRIC.COM.

Date and Revision

November 2010 Revision E

Document Part Number

975-0239-01-01

Product Part Numbers

Product Part Numbers

865-1000-01 – Xantrex XW6048 120/240 60

865-1005-01 – Xantrex XW4548 120/240 60

865-1010-01 – Xantrex XW4024 120/240 60

Related Product Part Numbers

865-1015 – Xantrex XW Power Distribution Panel





865-1025 – Xantrex XW Conduit Box

865-1020 – Xantrex XW Connection Kit for INV2

865-1030-1 – Xantrex XW Solar Charge Controller

Contact Information

www.schneider-electric.com

			
North America	1 650 351 8237 1 866 519 1470	1 925 245 1022	re.techsupport@schneider-electric.com
France	0 825 012 999		fr-re-techsupport@fr.schneider-electric.com
Deutschland	+49 (0) 180 575 3 575	+49 (0) 2102 404 7101	pv-service@de.schneider-electric.com
España	+34 902 101 813	+34 933 055 026	es-sat@es.schneider-electric.com
L'Italia	+39 035 4151111	+39 035415 3200	IT-pronto-contatto@it.schneider-electric.com

For other country details please contact your local Schneider Electric Sales Representative or visit our website at: <http://www.schneider-electric.com/sites/corporate/en/support/operations/local-operations/local-operations.page>

About This Guide

Purpose

The purpose of this Installation Guide is to provide explanations and procedures for installing the Schneider Electric Xantrex XW Power System.

Scope

The Guide provides safety guidelines, detailed planning, and procedures for installing the Xantrex XW Inverter/Charger and related system components (the Xantrex XW Power System). It does not provide details about configuration, operation, maintenance, or troubleshooting. See the Operation Guide or Owner's Manual of each device for this information. This Guide does not provide details about particular brands of batteries. You must consult individual battery manufacturers for this information.

Audience

The Guide is intended for use by anyone who plans to construct or install a system involving the Xantrex XW Power System. The information in this manual is intended for qualified personnel. Qualified personnel have training, knowledge, and experience in:

- installing electrical equipment and PV power systems (up to 1000 V),
- applying all applicable installation codes,
- analyzing and reducing the hazards involved in performing electrical work, and,
- selecting and using Personal Protective Equipment (PPE).

Organization

This guide is organized into five chapters and four appendices.

Chapter 1, "Introduction" lists and describes the components and basic features of the Xantrex XW Power System.

Chapter 2, "Inverter/Charger Installation" describes how to mount and install the Xantrex XW Inverter/Charger, and the Xantrex XW Power Distribution Panel and Xantrex XW Conduit Box.

Chapter 3, "Xantrex Xanbus Network Installation" provides detailed information for planning and installing the components necessary for network communication on a Xantrex Xanbus system.

Chapter 4, "Xantrex XW Solar Charge Controller Installation" describes how to mount and connect the Xantrex XW Solar Charge Controller as part of the Xantrex XW System.

Chapter 5, "Xantrex XW System Accessories Installation" describes how to mount and install the Xantrex XW System Control Panel and the Xantrex XW Automatic Generator Start.

Appendix A, "Specifications" provides the electrical and environmental specifications for the Xantrex XW Series Inverter/Charger.

Appendix B, "Wiring Diagrams" illustrate the most basic configurations and are for reference only. Specific installations may require additional equipment to meet national or local electric codes. Ensure all safety requirements are strictly followed.

Appendix C, "Alternate System Configurations" provides wiring diagrams for inverter/charger installations that do not require use of the Xantrex XW Power Distribution Panel and the Xantrex XW Conduit Box.

Appendix D, "Split-Phase to Single-Phase Conversion Instructions" provides instructions for converting a Xantrex XW Inverter/Charger 120 V/240 V, split-phase model to a 120 V, single-phase model.

Conventions Used

The following conventions are used in this guide.



WARNING

Warnings identify conditions or practices that could result in personal injury or loss of life.



CAUTION

Cautions identify conditions or practices that could result in damage to the Xantrex XW Power System components or other equipment.

Abbreviations and Acronyms

CEC	California Energy Commission
CSA	Canadian Standards Association
GT	Grid Tie
LCD	Liquid Crystal Display
LED	Light Emitting Diode
MPPT	Maximum Power Point Tracking
NEC	US National Electrical Code NFPA-70
PV	Photovoltaic
PVGFP	PV Ground Fault Protection
UL	Underwriters Laboratories
VAC	Volts AC
VDC	Volts DC
VMPP	Voltage at Maximum Power Point
VOC	Open Circuit Voltage

Related Information

For additional information about operating the Xantrex XW Inverter/Charger, see the *Xantrex XW Inverter/Charger Operation Guide* (975-0240-01-01).

For more information about related components, see:

- *Xantrex XW Power System Installation Overview* (975-0238-01-01)
- *Xantrex XW System Control Panel Owner's Guide* (975-0298-01-01)
- *Xantrex XW Solar Charge Controller Owner's Guide* (975-0283-01-01)
- *Xantrex XW Automatic Generator Start Owner's Guide* (975-0307-01-01)

These guides are available at www.schneider-electric.com. Printed copies are included with the components.

For more information about Schneider Electric as well as its products and services visit www.schneider-electric.com.

Important Safety Instructions



WARNING

This chapter contains important safety and operating instructions as required by UL and CSA standards for inverters used in residential applications. **Read and keep this Installation Guide for future reference.**

1. **Before using the inverter, read all instructions and cautionary markings on the unit, the batteries, and all appropriate sections of this manual.**
2. Use of accessories not recommended or sold by the manufacturer may result in a risk of fire, electric shock, or injury to persons.
3. The inverter is designed to be permanently connected to your AC and DC electrical systems. The manufacturer recommends that all wiring be done by a certified technician or electrician to ensure adherence to the local and national electrical codes applicable in your jurisdiction.
4. To avoid a risk of fire and electric shock, make sure that existing wiring is in good condition and that wire is not undersized. Do not operate the inverter with damaged or substandard wiring.
5. Do not operate the inverter if it has been damaged in any way. If the unit is damaged, see the Warranty and Product Information section at the end of this manual.
6. This unit does not have any user-serviceable parts. Do not disassemble the inverter except where noted for connecting wiring and cabling. See the Warranty Section in the *Xantrex XW Inverter/Charger Operation Guide* and other component manuals for instructions on obtaining service. Attempting to service the unit yourself may result in a risk of electrical shock or fire. Internal capacitors remain charged after all power is disconnected.
7. To reduce the risk of electrical shock, disconnect both AC and DC power from the inverter before attempting any maintenance or cleaning or working on any components connected to the inverter. Putting the unit in Standby mode will not reduce this risk.
8. The inverter must be provided with an equipment-grounding conductor connected to the AC input ground.
9. Do not expose this unit to rain, snow, or liquids of any type. This product is designed for indoor use only. Damp environments will significantly shorten the life of this product and corrosion caused by dampness will not be covered by the product warranty.
10. To reduce the chance of short-circuits, always use insulated tools when installing or working with this equipment.
11. Remove personal metal items such as rings, bracelets, necklaces, and watches when working with batteries.

Limitations on Use



WARNING: Limitations on Use

The Xantrex XW Power System is not intended for use in connection with life support systems or other medical equipment or devices.

Single-Phase Operation Only



CAUTION

The Xantrex XW4024 120/240 60, Xantrex XW4548 120/240 60, and Xantrex XW6048 120/240 60 series of inverter/chargers are designed and tested for operation with single phase, three wire (120V/240V) AC sources and should not be connected to a three-phase AC source. Connecting the device to a three-phase source may result in damage to the unit and any loads connected to the inverter/charger.

Explosive Gas Precautions

1. Working in the vicinity of lead acid batteries is dangerous. Batteries generate explosive gases during normal operation. Therefore, you must read this guide and follow the instructions exactly before installing or using your inverter/charger.
2. To reduce the risk of battery explosion, follow these instructions and those published by the battery manufacturer and the manufacturer of the equipment in which the battery is installed.

FCC Information to the User

This equipment has been tested and found to comply with the limits for a Class B digital device, pursuant to part 15 of the FCC Rules. These limits are designed to provide reasonable protection against harmful interference in a residential installation.

This equipment generates, uses and can radiate radio frequency energy and, if not installed and used in accordance with the instructions, may cause harmful interference to radio communications. However, there is no guarantee that interference will not occur in a particular installation. If this equipment does cause harmful interference to radio or television reception, which can be determined by turning the equipment off and on, the user is encouraged to try to correct the interference by one or more of the following measures:

- Reorient or relocate the receiving antenna.
- Increase the separation between the equipment and the receiver.
- Connect the equipment to a circuit different from that to which the receiver is connected.
- Consult the dealer or an experienced radio/TV technician for help.

Contents

Important Safety Instructions - - - - -	viii
1 Introduction	
System Overview - - - - -	1-2
System Diagram - - - - -	1-2
System Components and Accessories - - - - -	1-3
Xantrex XW Inverter/Charger - - - - -	1-3
Xantrex XW Conduit Box - - - - -	1-4
Xantrex XW Power Distribution Panel and Xantrex XW Conduit Box - - - - -	1-4
Xantrex XW Connection Kit for INV2 - - - - -	1-6
Xantrex XW Solar Charge Controller - - - - -	1-7
Xantrex XW System Control Panel - - - - -	1-8
Xantrex XW Automatic Generator Start - - - - -	1-8
Xantrex XW Jumpers (For Single-Phase Conversion) - - - - -	1-9
2 Inverter/Charger Installation	
Pre-Installation - - - - -	2-2
Location - - - - -	2-2
Knockout Preparation and Air Filter Installation - - - - -	2-3
Removing Internal Faceplates in the Power Distribution Panel - - - - -	2-3
Clearance Requirements - - - - -	2-4
Mounting - - - - -	2-4
Step 1: Installing the Mounting Plate - - - - -	2-5
Step 2: Mounting the Inverter - - - - -	2-7
Step 3: Mounting the Xantrex XW Power Distribution Panel and Xantrex XW Conduit Box - - - - -	2-8
Step 4: Wiring the Inverter - - - - -	2-9
Batteries - - - - -	2-10
Battery Bank Requirements - - - - -	2-11
Battery Cable Requirements - - - - -	2-11
Torque Values for the Xantrex XW Series Inverter/Charger - - - - -	2-12
Torque Values for the Xantrex XW Power Distribution Panel - - - - -	2-13
Inverter Grounding - - - - -	2-14
Feed-in Protection Requirements - - - - -	2-14
Wiring the Inverter to the Xantrex XW Power Distribution Panel - - - - -	2-14
Grounding the DC System - - - - -	2-14
Installing the Battery Temperature Sensor - - - - -	2-15
Making DC Connections - - - - -	2-17
Making AC Connections - - - - -	2-19
AC Connections and Communication Ports - - - - -	2-20
Accessing the AC Terminal Block and AC Ground Bar - - - - -	2-21

AC Equipment Grounding	2-22
AC Wiring to the Inverter Load Sub-Panel	2-23
AC System Bonding	2-24
AC Wiring to the Xantrex XW Power Distribution Panel	2-25
Wiring the Xantrex XW Inverter/Charger to a Xantrex XW Power Distribution Panel	2-27
Generator Wiring to the Xantrex XW Inverter/Charger Using a Xantrex XW Power Distribution Panel	2-28
AUX Port	2-30
AUX+12V Voltage Supply	2-31
AUX-RPO: User Remote Power OFF (RPO)	2-31
User Line Wiring	2-31
AUX Port Terminal Assignments	2-31
Basic Functional Test – Single Inverter	2-32
Confirm All Connections	2-32
Applying DC Power to the Inverter	2-32
Enable the Inverter	2-33
AC Voltage Check	2-35
Confirming Battery Charger Operation	2-36
Step 5: Installing Additional Inverters	2-38
Installation Steps	2-38
Parts List for a Dual-Inverter Configuration	2-38
Converting a Single-Inverter Power Distribution Panel to a Dual-Inverter Power Distribution Panel	2-39
DC Wiring for a Dual-Inverter System	2-39
AC Wiring for a Dual-Inverter System	2-41
Parts List for a Triple-Inverter Configuration	2-44
Converting a Single-Inverter Xantrex XW Power Distribution Panel to a Triple-Inverter Xantrex XW Power Distribution Panel	2-45
DC Wiring for a Triple-Inverter System	2-45
AC Wiring for a Triple-Inverter System	2-46
Parts List for a Four-Inverter System	2-50
Installing a Four-Inverter System	2-51
Xantrex Xanbus and AC Sync Cable	2-52
Basic Functional Test - Multiple Inverters	2-53

3 Xantrex Xanbus Network Installation

Xantrex Xanbus-Enabled Devices	3-2
The Xantrex Xanbus System	3-2
Network Components	3-3
Ordering Network Components	3-4
Network Layout	3-4
Installing the Network	3-5
Before You Begin the Installation	3-5
Installation Tools and Materials	3-5

Guidelines for Routing the Xantrex Xanbus Cables	3-6
Installing Xantrex Xanbus-Enabled Devices	3-6
4 Xantrex XW Solar Charge Controller Installation	
Installing the Xantrex XW Solar Charge Controller	4-2
PV Array Requirements	4-2
MPPT Voltage Range	4-2
Mounting	4-3
Choosing a Location	4-3
Removing the Wiring Compartment Cover	4-5
Removing Knockouts	4-5
Mounting the Xantrex XW Solar Charge Controller	4-7
Grounding	4-9
Internal Ground Fault Protection	4-9
Disabling Ground Fault Protection for Negative Grounded and Ungrounded Arrays	4-11
Wiring	4-12
DC Terminal Connector Locations	4-12
Wire Size and Overcurrent Protection Requirements	4-12
Current Rating	4-13
Minimum Wire Gauge	4-13
Overcurrent Protection	4-13
Long-Distance Wire Runs	4-14
Maximum One-way Distance and Wire Size	4-15
Connecting the Xantrex XW Solar Charge Controller to the Distribution Panel	4-17
Commissioning-	4-19
Configuration Screens	4-19
Commissioning Units Using a Xantrex XW System Control Panel	4-20
5 Xantrex XW System Accessories Installation	
The Xantrex XW System Control Panel	5-2
Materials and Tools Required	5-3
Choosing a Location	5-3
Mounting the Xantrex XW System Control Panel	5-4
Verifying the Installation	5-7
The Xantrex XW Automatic Generator Start	5-7
Preparing an Installation	5-8
Materials and Tools Required	5-8
Choosing a Location	5-9
Routing the Connections	5-9
Installing the Xantrex XW Automatic Generator Start	5-10
Mounting the Unit	5-11
Wiring to the 20-contact Connector	5-11
Connecting the Generator	5-14
Connecting the Thermostats (Optional)	5-15

Connecting an External Shutdown (Optional)	5-15
Connecting an External Manual ON/OFF Switch (Optional)	5-16
Connecting an External ON/OFF LED	5-17
Connecting the Wiring Harness to the Xantrex XW Automatic Generator Start	5-18
Connecting the Xantrex XW Automatic Generator Start to the Xantrex Xanbus Network	5-19
Verifying Power Is Available	5-20

A Specifications

Electrical Specifications	A-2
Grid-tie Specifications	A-3
Xantrex XW Series Inverter/Charger Overload Capability	A-4
Output Power Versus Ambient Temperature	A-6
Xantrex XW Series Inverter/Charger Efficiency	A-6
Inverting Efficiency (Typical)	A-6
Charging Efficiency (Typical)	A-7
Charging Power Factor	A-7
Grid-tie Sell Mode Efficiency (Typical)	A-8
Mechanical Specifications	A-9
Accessories	A-10

B Wiring Diagrams

Single-Inverter System (Backup Only) Without a Power Distribution Panel	B-3
Single-Inverter System (Backup Only) With a Power Distribution Panel	B-4
Single-Inverter System Renewable Energy (Solar)	B-5
Single-Inverter System Renewable Energy (Wind or Hydro)	B-6
Dual-Inverter System Renewable Energy (Solar)	B-7
Dual-Inverter System Renewable Energy (Wind or Hydro)	B-8
AC Wiring for a Four-Inverter System	B-9

C Alternate System Configurations

DC Grounding for Single-Inverter Systems	C-2
Battery Connections for Single Inverter Systems	C-3
AC Grounding for Single-Inverter Systems	C-4
AC Output Wiring to the Inverter Load Sub-Panel	C-5
Generator Wiring to the Inverter	C-6
Utility Wiring to the Inverter Input	C-7

D Split-Phase to Single-Phase Conversion Instructions

Converting 120 V/240 V Split-Phase to 120 V Single-Phase	D-3
Parts and Tools Required	D-3
Disconnecting Power Sources	D-4
Removing the Wiring Compartment Cover	D-4
Reconfiguring the Secondary Transformer Wires on X1 and X2 Connectors	D-5
Reconfiguring the AC Ports on the Load, AC1, and AC2 Connectors	D-7
Upgrading the Firmware	D-8

Updating the Label	D-9
Xantrex XW 120 V Balanced Three-Phase System with Renewable Energy (Solar) – Customer-Supplied AC Breakers	D-11
Xantrex XW 120 V Balanced Three-Phase System with Renewable Energy (Solar) – Manufacturer-Supplied AC Breakers	D-12
Xantrex XW 120 V Single-Phase System with Renewable Energy (Solar) – Manufacturer- Supplied AC Breakers	D-13

Figures

Figure 1-1	Xantrex XW Power System Installation Diagram Example	1-2
Figure 1-2	Xantrex XW Inverter/Charger	1-3
Figure 1-3	Xantrex XW Conduit Box	1-4
Figure 1-4	Xantrex XW Power Distribution Panel and Xantrex XW Conduit Box	1-5
Figure 1-5	Xantrex XW Connection Kit for INV2	1-6
Figure 1-6	Xantrex XW Solar Charge Controller	1-7
Figure 1-7	Xantrex XW System Control Panel	1-8
Figure 1-8	Xantrex XW Automatic Generator Start	1-9
Figure 2-1	Air Filter and AUX Connector Installation	2-3
Figure 2-2	Removing the Internal Faceplates on the Xantrex XW Power Distribution Panel	2-3
Figure 2-3	Clearance Requirements	2-4
Figure 2-4	Mounting Plate Dimensions	2-5
Figure 2-5	Mounting the Bracket for the Xantrex XW Inverter/Charger or Xantrex XW Power Distribution Panel	2-6
Figure 2-6	Mounting the Xantrex XW Inverter/Charger	2-7
Figure 2-7	Installing the Xantrex XW Conduit Box	2-8
Figure 2-8	Routing Communications Cables	2-10
Figure 2-9	DC Grounding Using a Xantrex XW Power Distribution Panel	2-15
Figure 2-10	Battery Temperature Sensor (RJ11) Port Location and Installation	2-16
Figure 2-11	Xantrex XW Inverter/Charger DC Connections	2-17
Figure 2-12	Battery Cable Connection	2-18
Figure 2-13	DC Connections to a Single Inverter Using a Xantrex XW Power Distribution Panel	2-19
Figure 2-14	Xantrex XW Inverter/Charger AC Connections and Communications Ports	2-20
Figure 2-15	AC Terminal Block	2-21
Figure 2-16	AC Equipment Grounding Using the Distribution Panel	2-22
Figure 2-17	Wiring the Xantrex XW Power Distribution Panel to the Inverter Load Sub-Panel or Utility Grid	2-26
Figure 2-18	Wiring the Inverter to the Xantrex XW Power Distribution Panel	2-27
Figure 2-19	Generator Wiring Using a Xantrex XW Power Distribution Panel (On Grid)	2-28
Figure 2-20	Generator Wiring Using a Xantrex XW Power Distribution Panel (Off Grid)	2-29
Figure 2-21	AUX Port Location	2-30
Figure 2-22	Power-up Display	2-33
Figure 2-23	Enable the Inverter	2-34
Figure 2-24	Checking AC Voltage	2-35
Figure 2-25	Checking Charging Operation	2-36
Figure 2-26	Functional Test for Single Inverter Systems	2-37
Figure 2-27	DC Connections to Dual Inverters	2-40
Figure 2-28	Dual Inverter AC Breaker Arrangement and Wiring Enlargement with Multiple AC Input Sources	2-41

Figures

Figure 2-29	AC Wiring for Dual-Inverter Systems	2-42
Figure 2-30	Installing the Front Internal Panels and the AC Bypass Plate	2-43
Figure 2-31	DC Connections for a Triple-Inverter System	2-46
Figure 2-32	Triple-Inverter AC Breaker Arrangement and Wiring Enlargement with Two AC Input Sources	2-48
Figure 2-33	Triple-Inverter AC Breaker Arrangement and Wiring Enlargement with a Single AC Input Source	2-49
Figure 2-34	Wiring an External Bypass Switch for a Triple-Inverter Configuration	2-50
Figure 2-35	Installing the AC Sync Cable	2-52
Figure 2-36	Functional Test for Multiple Inverters - Page 1 of 2	2-55
Figure 2-37	Functional Test for Multiple Inverters - Page 2 of 2	2-56
Figure 3-1	Network-Managed Power System	3-2
Figure 3-2	Xantrex Xanbus Cable, RJ45 Connector Pin Numbers and Network Terminators	3-3
Figure 3-3	Network Layout	3-5
Figure 4-1	Minimum Clearance Requirements	4-4
Figure 4-2	Removing the Wiring Compartment Cover	4-5
Figure 4-3	Dimensions and Knockout Locations	4-6
Figure 4-4	Knockout Dimensions	4-6
Figure 4-5	Mounting the Xantrex XW Solar Charge Controller	4-8
Figure 4-6	Xantrex XW Solar Charge Controller Safety Ground Connector	4-10
Figure 4-7	PV Negative Ground Jumper Location	4-11
Figure 4-8	DC Connection Terminals	4-12
Figure 4-9	Connecting Solar DC Sources in the Power Distribution Panel	4-18
Figure 5-1	Xantrex XW System Control Panel Xantrex Xanbus Port Locations	5-2
Figure 5-2	Inserting the Mounting Plate	5-4
Figure 5-3	Securing the Mounting Plate	5-5
Figure 5-4	Connecting the Network Cables	5-5
Figure 5-5	Securing the Xantrex XW System Control Panel	5-5
Figure 5-6	Surface Mounting the Xantrex XW System Control Panel	5-7
Figure 5-7	Connecting the Xantrex XW AGS Communications Cable to the Xantrex XW Series Inverter/Charger	5-8
Figure 5-8	Xantrex XW Automatic Generator Start External Connections	5-10
Figure 5-9	Xantrex XW Automatic Generator Start Wiring Harness	5-13
Figure 5-10	External ON/OFF Switch and LED Wiring Diagram	5-17
Figure 5-11	Xantrex XW Automatic Generator Start External Connections	5-18
Figure 5-12	Connecting the Xantrex XW SCP	5-19
Figure 5-13	Verifying Power is Available	5-20
Figure A-1	Xantrex XW6048 120/240 60 AC Overload Capability	A-4
Figure A-2	Xantrex XW4548 120/240 60 AC Overload Capability	A-5
Figure A-3	Xantrex XW4024 120/240 60 AC Overload Capability	A-5
Figure A-4	Output Power Versus Ambient Temperature	A-6
Figure A-5	Inverting Efficiency (Typical)	A-6
Figure A-6	Charging Efficiency (Typical)	A-7
Figure A-7	Charging Power Factor	A-7

Figure A-8	Grid-tie Sell Mode Efficiency (Typical) - - - - -	A-8
Figure B-1	Single-Inverter System (Backup Only) Without a Power Distribution Panel - - - - -	B-3
Figure B-2	Single-Inverter System (Backup Only) With a Power Distribution Panel- - - - -	B-4
Figure B-3	Single-Inverter System Renewable Energy (Solar) - - - - -	B-5
Figure B-4	Single-Inverter System Renewable Energy (Wind or Hydro) - - - - -	B-6
Figure B-5	Dual-Inverter System Renewable Energy (Solar) - - - - -	B-7
Figure B-6	Dual-Inverter System Renewable Energy (Wind or Hydro)- - - - -	B-8
Figure B-7	AC Wiring for a Four-Inverter System- - - - -	B-9
Figure C-1	DC Grounding for an Inverter Only - - - - -	C-2
Figure C-2	DC Connections to a Single Inverter - - - - -	C-3
Figure C-3	Grounding the AC System - - - - -	C-4
Figure C-4	AC Output Wiring to the Inverter Load Sub-Panel- - - - -	C-5
Figure C-5	Generator Wiring directly to the Inverter - - - - -	C-6
Figure C-6	Utility Wiring to the Inverter Input - - - - -	C-7
Figure D-1	Jumpers - - - - -	D-3
Figure D-2	Xantrex XW Inverter/Charger Front View - - - - -	D-4
Figure D-3	Connector Locations. - - - - -	D-5
Figure D-4	Slot Locations on X1 and X2 Connectors - - - - -	D-6
Figure D-5	X1 and X2 Connectors Before and After Reconfiguration - - - - -	D-6
Figure D-6	Jumper Locations and AC Cable Configuration on AC Ports - - - - -	D-7
Figure D-7	Xantrex XWConfig - - - - -	D-8
Figure D-8	Updated Label - - - - -	D-9
Figure D-1	Xantrex XW 120 V Balanced Three-Phase System with Renewable Energy (Solar) – Customer-Supplied Breakers - - - - -	D-11
Figure D-2	Xantrex XW 120 V Balanced Three-Phase System with Renewable Energy (Solar) – Manufacturer-Supplied Breakers- - - - -	D-12
Figure D-3	Xantrex XW 120 V Single-Phase System with Renewable Energy (Solar) – Manufacturer- Supplied AC Breakers - - - - -	D-13

Tables

Table 2-1	Mounting Plate Fastener Recommendations	2-5
Table 2-2	Recommended Battery Cable Size Versus Length	2-12
Table 2-3	Battery Cable (in Conduit) to Maximum Breaker/Fuse Size	2-12
Table 2-4	Torque Values for AC Wiring (AC Terminals and Ground Bar)	2-12
Table 2-5	Torque Values for the Chassis Ground Lug	2-12
Table 2-6	Torque Values for the Inverter Battery Terminals	2-13
Table 2-7	Torque Values for AC Disconnects and AC Breakers	2-13
Table 2-8	Torque Values for the Ground Bus, AC Neutral Bus, DC Negative Bus, and DC Positive Bus in the Xantrex XW Power Distribution Panel	2-13
Table 2-9	Torque Values for the Power Distribution Bars in the Xantrex XW Power Distribution Panel	2-13
Table 2-10	Torque Values for the Battery Cables to the DC Negative Bus, and DC Positive Bus in the Xantrex XW Power Distribution Panel	2-13
Table 2-11	User Connector Terminals and Functions	2-31
Table 2-12	Wiring Components and Part Numbers	2-48
Table 3-1	Xantrex Xanbus Network Components and Part Numbers	3-4
Table 4-1	MPPT Operational Window	4-2
Table 4-2	Minimum Clearance Requirements	4-4
Table 4-3	Recommended Circuit Breakers for the Xantrex XW Solar Charge Controller	4-14
Table 4-4	One-Way Wire Distance and Wire Size for a 24 VDC System	4-15
Table 4-5	One-Way Wire Distance and Wire Size for a 48 VDC System	4-16
Table 5-1	Circuit Limitations	5-12
Table 5-2	Required Wiring Size Based on Length of Cable	5-12
Table 5-3	Contact Numbers and Functions	5-13
Table 5-4	Wiring for Connecting Thermostats	5-15
Table 5-5	Wiring for Connecting an External Shutdown	5-15
Table 5-6	Wiring for Connecting an External Manual ON/OFF Switch	5-16
Table A-1	Xantrex XW Power System Electrical Specifications	A-2
Table A-2	Xantrex XW Power System Mechanical Specifications	A-9
Table A-3	Xantrex XW Power System Regulatory Approvals	A-10

1

Introduction

Chapter 1, "Introduction" lists and describes the components and basic features of the Xantrex XW Power System.

For this Topic	See....
"System Overview"	page 1-2
"System Components and Accessories"	page 1-3

System Overview

The Xantrex XW Power System consists of several devices, components, and optional accessories that, when installed together, create a renewable energy power system that can be customized to suit nearly any application—off-grid, grid-tie, or backup. Up to four inverters can be installed in parallel to create larger 120/240 volt, 3-wire, single-phase systems allowing for increased capacity.



CAUTION

The Xantrex XW4024 120/240 60, Xantrex XW4548 120/240 60, and Xantrex XW6048 120/240 60 series of inverter/chargers are designed and tested for operation with single phase, three wire (120 V/240 V) AC sources and should not be connected to a three-phase AC source. Connecting the device to a three-phase source may result in damage to the unit and any loads connected to the inverter/charger.

System Diagram

Dual-Inverter System with Renewable Energy (Solar)

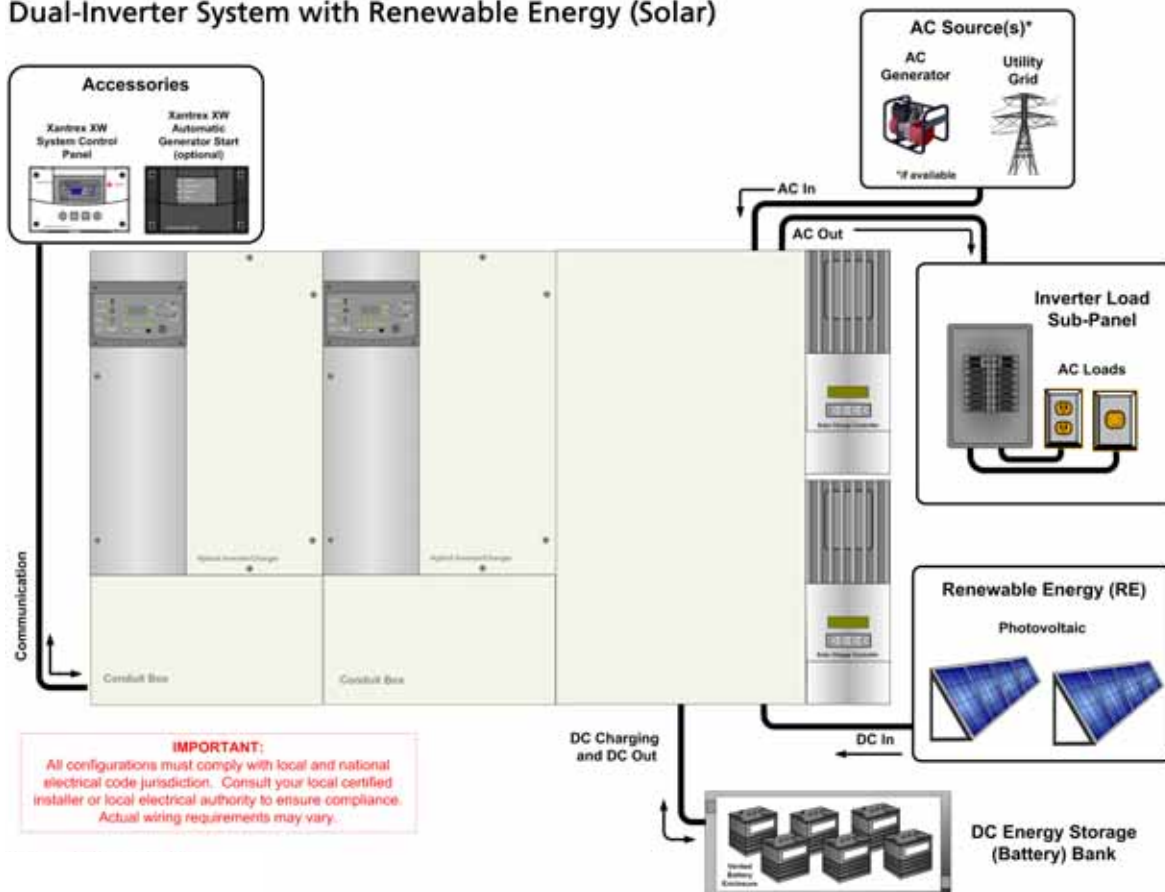

Figure 1-1 Xantrex XW Power System Installation Diagram Example

System Components and Accessories

Xantrex XW Inverter/Charger

The Xantrex XW Inverter/Charger is a modular building block sine-wave inverter/charger that can be used for both residential and commercial stand-alone, grid-backup, and grid-tie applications with battery energy storage. The Xantrex XW Series Inverter/Charger is a self-contained DC to AC inverter, battery charger, and AC transfer switch. Up to four inverters can be installed in parallel to create larger 120-240 volt, 3-wire, single-phase systems allowing for increased capacity.



Includes:

- Mounting Panel
- DC terminal Covers
- Network Terminator
- Battery Temperature Sensor
- Air Filter
- Mounting Hardware
- AUX Port Connector

Figure 1-2 Xantrex XW Inverter/Charger

A Battery Temperature Sensor (part number 808-0232-02) is also included with the Xantrex XW Inverter/Charger. The Battery Temperature Sensor monitors the temperature of the battery bank and adjusts the charging accordingly. See page 2-15 for installation instructions for this accessory.

Xantrex XW Conduit Box

A conduit box (part number 865-1025) is available to enclose the bottom of the Xantrex XW Inverter/Charger and protect the cabling. Use of the conduit box may be required depending on the local electrical code. Be sure to consult with the local electrical authority to ensure the installation is code-compliant.



Figure 1-3 Xantrex XW Conduit Box

The Xantrex XW Conduit Box comes in two pieces and mounts directly to the bottom of the inverter/charger with keyhole slots and screws. It is secured to the inverter by two #10-32 screws and is secured to the wall by two screws (not provided).

Internal wire barriers (or raceways) are included to keep communications wires separate from AC and DC power wires. The Xantrex XW Conduit Box also includes multiple cable strap points.

Xantrex XW Power Distribution Panel and Xantrex XW Conduit Box

The Xantrex XW Power Distribution Panel (part number 865-1015) includes a mounting plate and Xantrex XW Conduit Box. It is factory wired and labelled with everything to support a code-compliant single-inverter installation. It is designed to mount on the right side of the inverter/charger, but it can also be configured to mount on the left side. Internal wiring and breakers can be added to expand the Xantrex XW Power System with up to three inverters, four charge controllers, or other equipment to support 120/240 volt, 3-wire, single-phase systems.

The Xantrex XW Power Distribution Panel and Xantrex XW Conduit Box interface with:

- Xantrex XW4024 120/240 60, Xantrex XW4548 120/240 60, and Xantrex XW6048 120/240 60 inverter/chargers
- Xantrex XW Solar Charge Controllers (requires customer supplied breakers and wiring)
- C-Series Charge Controllers (requires customer supplied breakers and wiring).

Internal wire barriers (or raceways) are included to keep communications wires separate from AC and DC power wires.

Xantrex XW Power Distribution Panel



Xantrex XW Power Distribution Panel includes:

- Xantrex XW Power Distribution Panel enclosure with a field-reversible panel door
- Mounting Plate
- Xantrex XW Conduit Box

Mounting Plate

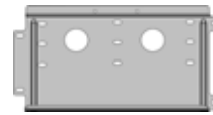

Xantrex XW Conduit Box



Xantrex XW Power Distribution Panel Dimensions:
 30" (761mm) H x 16" (406mm) W x 8 1/4" (210mm) D
 Depth from the wall = 8 3/4" (223 mm)



The enclosure comes pre-wired with:

- 3x 60A, 120/240 VAC, 2-pole, Square-D, Type QOU, DIN-rail mounted AC breakers (pre-wired to connect to one Xantrex XW inverter)
- 1x GJ250A 160 VDC, 3/8" stud DC breaker
- 2x Ground terminal bus bars
- 1x Neutral terminal bus bar
- 1x Negative bus bar
- 1 pair #4/0 AWG Battery Cables

The panel door can be mounted on the right or left side of the Xantrex XW Power Distribution Panel.

AC Knockout slots = 9 (for dual 60 A Square D, type QOU breakers)*

DC Knockout slots = 8 small (for 60 A DC breakers) and 3 large (for GJ breakers)

*AC Breakers cannot exceed 60 A.

Figure 1-4 Xantrex XW Power Distribution Panel and Xantrex XW Conduit Box

Xantrex XW Connection Kit for INV2

The Xantrex XW Connection Kit for INV2 (part number 865-1020) is the extension kit required for connecting a second or third Xantrex XW Inverter/Charger in the same system.

Xantrex XW Connection Kit for INV2 includes:

- Xantrex XW Conduit Box with raceway barriers and cable strap connections points,
- 3x 60 A, 120/240 VAC, 2-pole, Square-D, Type OOU, Din-Rail mountable, AC breakers (includes bypass plate)
- #6 AWG AC wiring to connect the inverter to the AC breakers (includes 4 conduit bushings)
- #2 AWG ground wire
- 4x Power Distribution Bars (replaces factory-installed bars)
- 1x GJ250A 160 VDC, 3/8" stud DC breaker
- 1x Bus Bar for DC positive
- 1 pair #4/0 AWG battery cables
- AC Sync and Xantrex Xanbus™ cables (not shown)

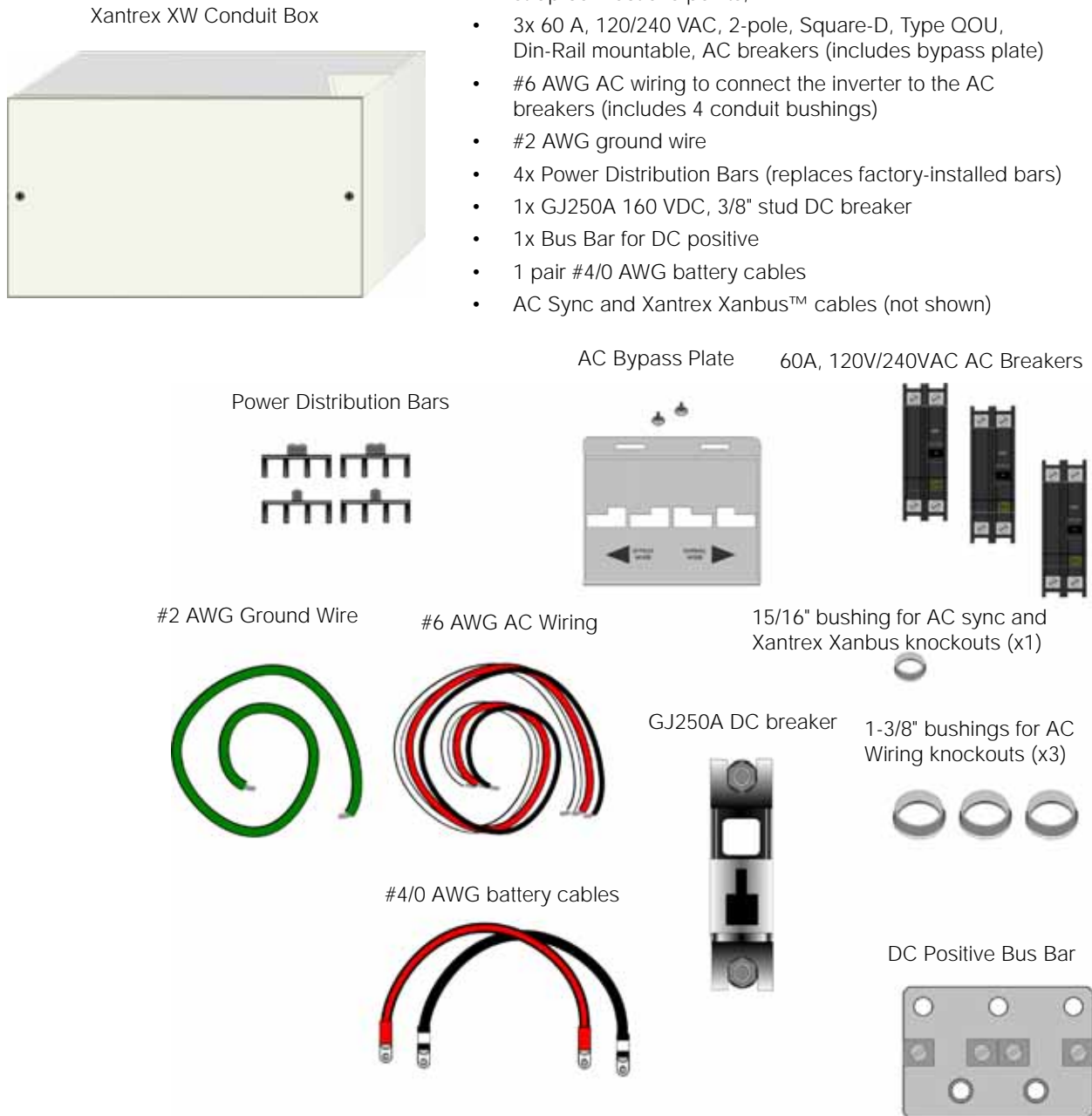

Figure 1-5 Xantrex XW Connection Kit for INV2

Xantrex XW Solar Charge Controller

The Xantrex XW Solar Charge Controller (part number 865-1030) is a 60 amp charge controller with integrated Xantrex PV GFP and separate Battery Temperature Sensor. The Xantrex XW Solar Charge Controller can be used with 12-, 24-, 36-, 48-, and 60-volt DC battery systems. However, the Xantrex XW Inverter/Charger can only work at 24 or 48 volts depending on the model. When the Xantrex XW Solar Charge Controller is used with the Xantrex XW Inverter/Charger, it is limited to 24 or 48 volt battery banks. The Xantrex XW Solar Charge Controller will automatically detect the 24 or 48 volt settings.



Figure 1-6 Xantrex XW Solar Charge Controller

Xantrex XW System Control Panel

The Xantrex XW System Control Panel features a graphical, backlit liquid crystal display that displays system configuration and diagnostic information for all devices connected to the network. When installed as a Xantrex XW Power System accessory, the Xantrex XW System Control Panel eliminates the need for separate control panels for each device and gives a single point of control to set up and monitor an entire Xantrex XW Power System.



Figure 1-7 Xantrex XW System Control Panel

Xantrex XW Automatic Generator Start

The Xantrex XW Automatic Generator Start can automatically activate a generator to provide a Xantrex XW Inverter/Charger with power to recharge depleted batteries or assist with heavy loads. The Xantrex XW Automatic Generator Start adds intelligence to power management and eliminates time spent monitoring batteries and inverter loads.

The Xantrex XW Automatic Generator Start is compatible with popular generators, and it can be configured to start the generator in response to low battery voltage, thermostat operation, or load size on the inverter battery. A quiet time setting prevents the generator from starting at inconvenient times. LEDs display the status of the Xantrex XW Automatic Generator Start, while all user-defined settings are programmed through the Xantrex XW System Control Panel.

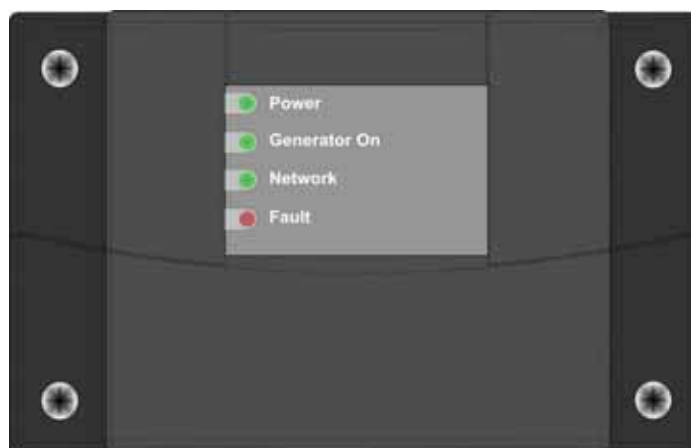

Figure 1-8 Xantrex XW Automatic Generator Start

Generator

The generator should be a 120V/240V, 2-wire or 3-wire generator with Auto Start capability.

Important: The inverter/charger will not accept power from a 120 volt generator, unless it has been converted to a 120 volt, 2-wire, single-phase unit.

The generator should also supply a Generator Run signal. This signal is used by the Xantrex XW Automatic Generator Start to detect whether the generator is running. Some generator manufacturers refer to this signal as the Hour Meter Signal or Switched B+.

Generator Compatibility

The Xantrex XW Automatic Generator Start supports most two and three-wire generator starters. Manufacturers include Onan (Quiet Diesel, gasoline, and LP), Power Tech, Generac, Northern Lights, Fisher Panda, Westerbeke, Kohler, Honda, and Yamaha. Check with the manufacturer to make sure the generator includes automatic starting capabilities.

Xantrex XW System Control Panel

A Xantrex XW System Control Panel is required to configure the Xantrex XW Automatic Generator Start and monitor generator starting and stopping activity. The Xantrex XW System Control Panel also provides real-time clock information for the Xantrex XW Automatic Generator Start Quiet Time and Exercise Time features.

Xantrex XW Jumpers (For Single-Phase Conversion)

The jumpers are used to reconfigure a standard Xantrex XW 120 V/240 V, 3-wire, split-phase model to accept a 120 V, 2-wire, single-phase connection. Use the jumpers to reconfigure the transformer wires. For instructions, see Appendix D, "Split-Phase to Single-Phase Conversion Instructions".

2

Inverter/Charger Installation

Chapter 2, "Inverter/Charger Installation" describes how to mount and install the Xantrex XW Inverter/Charger, and the Xantrex XW Power Distribution Panel and Xantrex XW Conduit Box.

For this Topic	See....
"Pre-Installation"	page 2-2
"Step 1: Installing the Mounting Plate"	page 2-5
"Step 2: Mounting the Inverter"	page 2-7
"Step 3: Mounting the Xantrex XW Power Distribution Panel and Xantrex XW Conduit Box"	page 2-8
"Step 4: Wiring the Inverter"	page 2-9
"Step 5: Installing Additional Inverters"	page 2-38

Pre-Installation

Before installing the Xantrex XW Inverter/Charger, read all instructions and cautionary markings located in this Guide.

Important: Be sure to obtain the appropriate permits, if necessary, prior to starting this installation. **Installations must meet all local codes and standards.** Installations of this equipment should only be performed by skilled personnel such as qualified electricians and Certified Renewable Energy (RE) System installers.



WARNING: Personal Injury

The Xantrex XW Inverter/Charger weighs approximately 120 pounds (54 kg). To prevent personal injury, always use proper lifting techniques and have someone assist with lifting during installation.

Location

The Xantrex XW Inverter/Charger is certified for indoor (heated or unheated) installations only.

Close to battery bank

Locate the inverter as close to the batteries as possible in order to keep the battery cable length short. The maximum recommended battery cable length is 10 feet (3 m).



WARNING: Explosion and Corrosion Hazard

Do not locate the inverter directly above the batteries or in the same compartment as vented batteries.

Locate any electronic equipment susceptible to radio frequency and electromagnetic interference as far away from the inverter as possible.

Fire safety

Do not locate the inverter near readily flammable materials such as cloth, paper, straw, or plastic sheeting. Flammable materials should be kept a minimum distance of 24 inches (60 cm) from the top surface and 12 inches (30 cm) from either side surface and the front of the Xantrex XW Inverter/Charger.

Knockout Preparation and Air Filter Installation

Remove your choice of knockouts from the chassis to facilitate conduit installation for wire runs. Make sure no debris from this procedure remains inside the inverter enclosure.

Important: Do not drill, cut, or punch holes into the Xantrex XW Power Distribution Panel. Use only the knockouts provided for conduit entry.

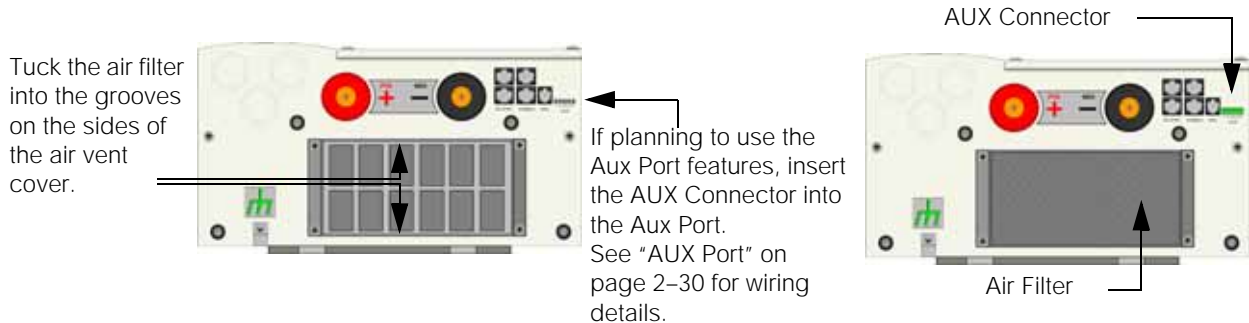

Figure 2-1 Air Filter and AUX Connector Installation

Removing Internal Faceplates in the Power Distribution Panel

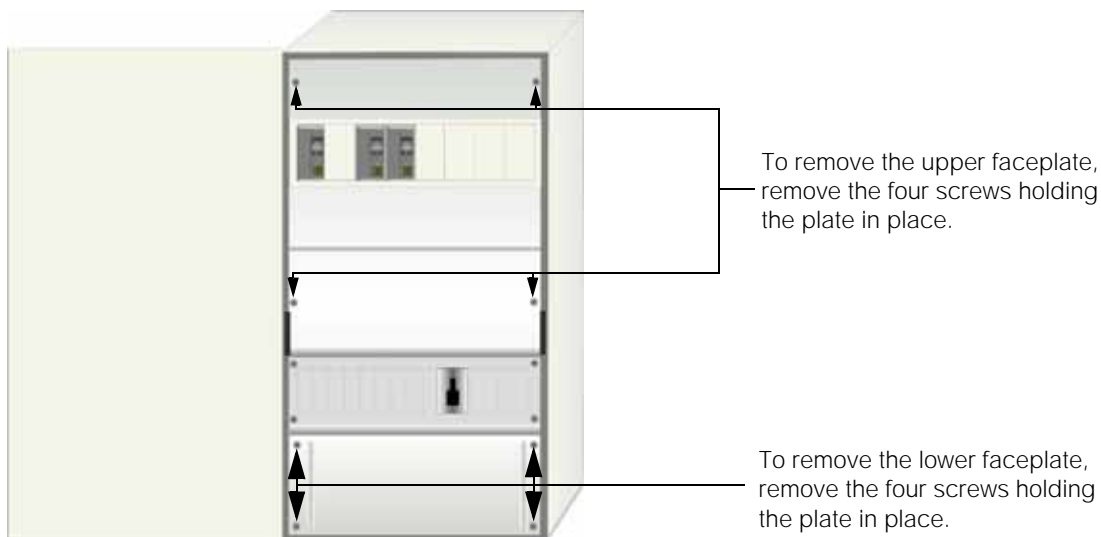

Figure 2-2 Removing the Internal Faceplates on the Xantrex XW Power Distribution Panel

Clearance Requirements

Provide a minimum clearance of 6 inches (15 cm)—12 inches is preferred—around the top and 6 inches (15 cm) at the bottom of the inverter for ventilation. There must be at least three feet of clearance in front of the inverter. Make sure the vents are not obstructed with foreign objects and the minimum clearances are met.

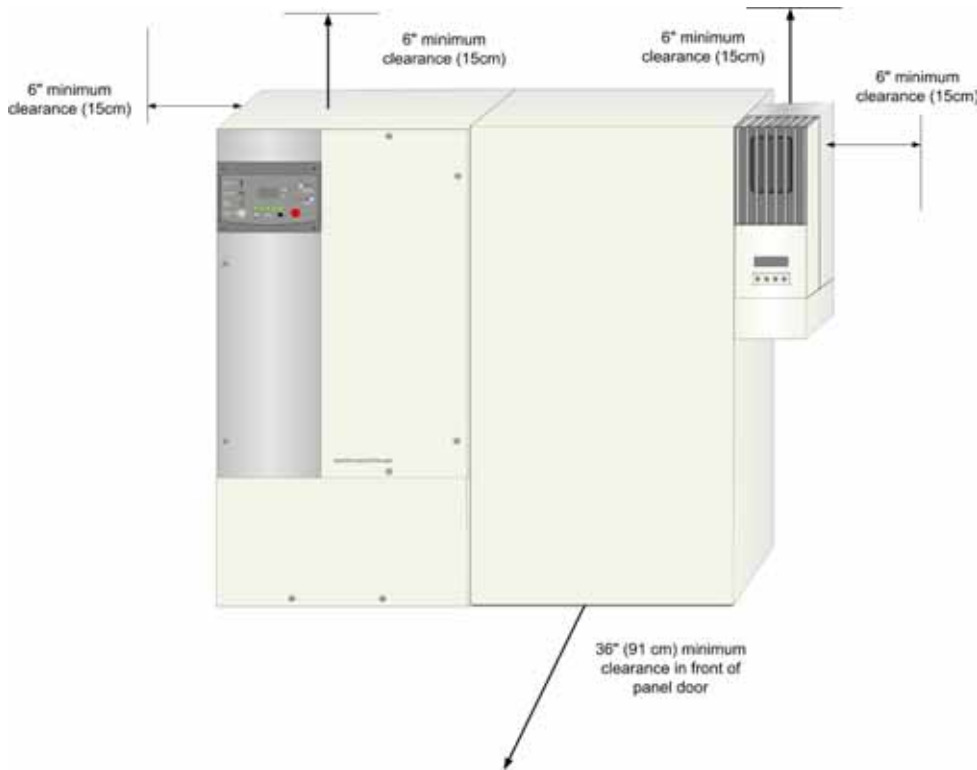

Figure 2-3 Clearance Requirements

Mounting

The Xantrex XW Power System is designed to be mounted on a vertical surface. The supporting surface must be strong enough to support a minimum of 500 pounds (227 kg). To facilitate installation, a wall mounting plate (part number 210-0462-01-01) is provided for each Xantrex XW Inverter/Charger and Xantrex XW Power Distribution Panel. The mounting plate and hardware on the Xantrex XW Inverter/Charger and Xantrex XW Power Distribution Panel are designed to meet standards for structural and seismic stability. When properly installed, the system also meets Section 59 of UL 1741 for Static Loads.

Step 1: Installing the Mounting Plate

Each Xantrex XW Inverter/Charger and Xantrex XW Power Distribution Panel requires a separate mounting plate. This bracket is first attached to the wall, and then the inverter/charger or distribution panel is attached to the wall bracket.

The wall bracket is attached to the wall with lag bolts or other fasteners, provided by the installer. A minimum of four 1/4-inch diameter fasteners are required. The fasteners must be strong enough to support 500 pounds.

The wall bracket has mounting holes spaced 16 inches (40 cm) apart and is designed to span two wall studs spaced 16 inches on-center. Additional mounting holes are also provided for flexibility in mounting options. If the wall does not have 16-inch on-center studs, the installer will need to provide adequate supports for the brackets. For example, a sheet of plywood can be attached to the wall, and the wall brackets can then be attached to plywood.

Both the Xantrex XW Inverter/Charger and Xantrex XW Power Distribution Panel use the same wall bracket. The brackets are designed to interlock (as shown in Figure 2-5), so that additional mounting plates are easily installed without additional measuring or levelling.

The type of fastener required to secure the mounting plate varies according to the vertical surface and wall structure of your installation location.

Table 2-1 Mounting Plate Fastener Recommendations

Structure	Required Fastener	Number of Screws Per Bracket
Wood studs at 16" (on center - O.C.)	1/4" Ø × 3 1/2" long lag screw	Four
Wood studs not at 16" O.C. (3/4" minimum plywood panel required)	1/4" Ø × 1" long wood screw	Six
Steel studs at 16" O.C. (minimum 18 gauge)	1/4" Ø self-drilling screw	Four

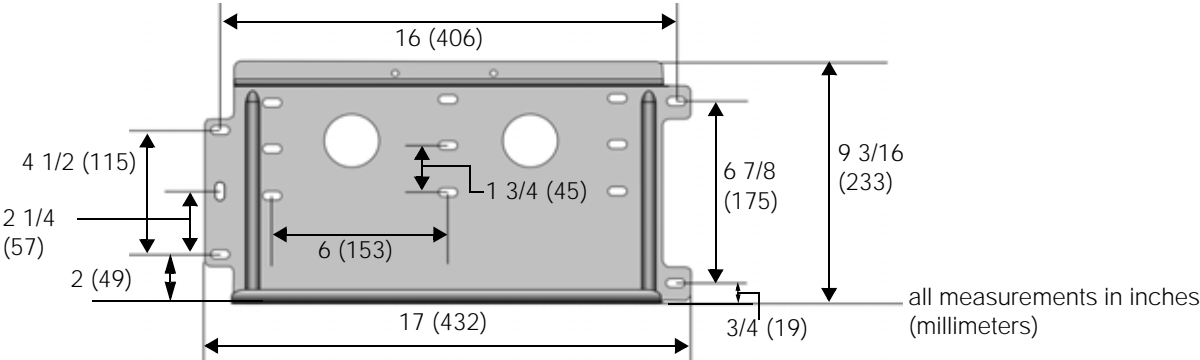
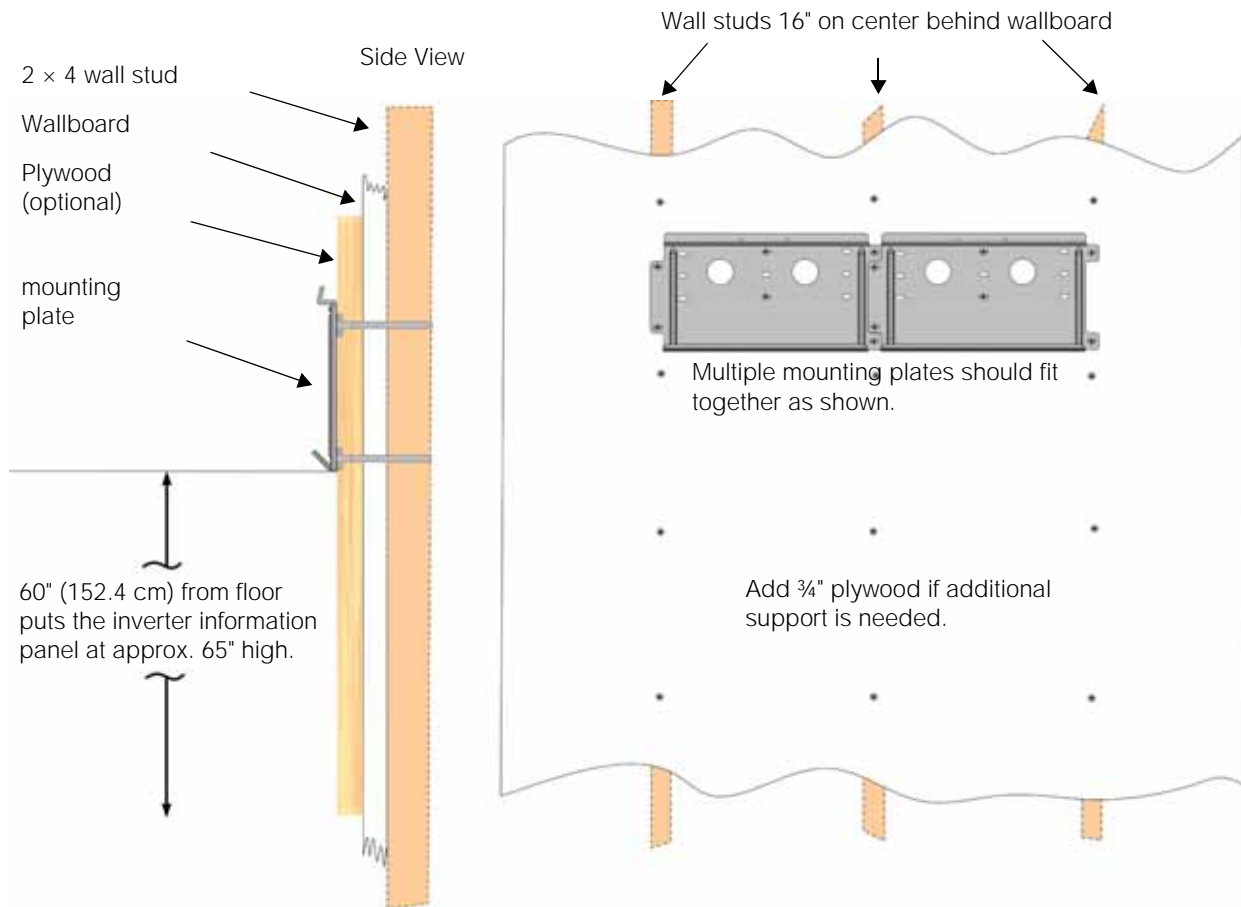

Figure 2-4 Mounting Plate Dimensions



- 1 Locate the wall studs.
- 2 If necessary, enhance the support surface with a 3/4" plywood panel secured to the wall studs. Plywood must span at least three wall studs.
- 3 Use hardware sized to support a minimum of 500 lbs (not supplied) to secure the plywood to the wall.
- 4 Using a level, secure the first mounting bracket to the wall. Use recommended anchoring hardware to secure the plate (see Table 2-1).
- 5 Mount the next bracket adjacent to the first one. The brackets are designed to interlock, so additional mounting brackets are easily installed without additional measuring or levelling.

Figure 2-5 Mounting the Bracket for the Xantrex XW Inverter/Charger or Xantrex XW Power Distribution Panel

Step 2: Mounting the Inverter

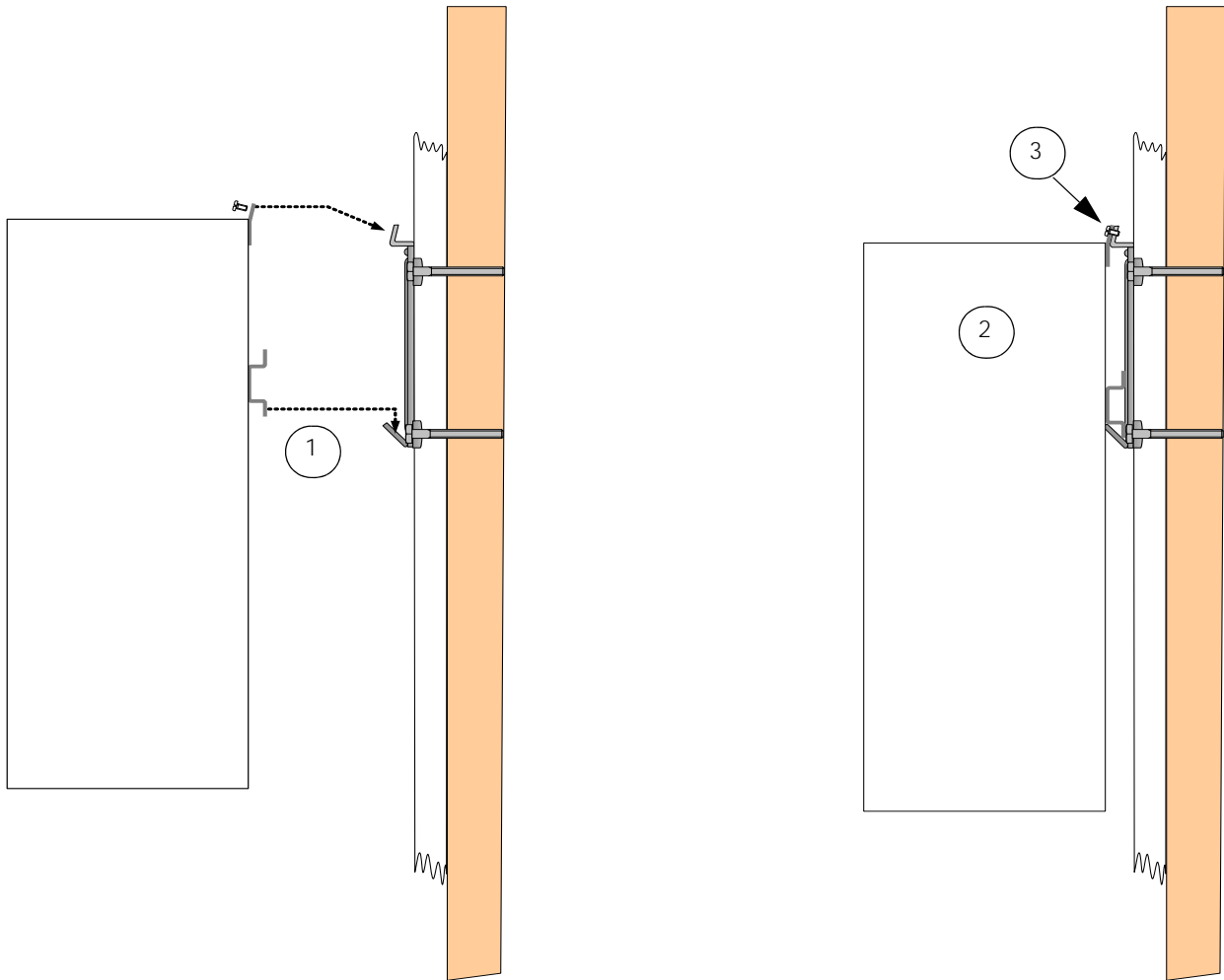

- 1 Align the flange on the back of the Xantrex XW Inverter/Charger with the bottom edge of the mounting plate.
- 2 Lower the flange on the inverter onto the mounting plate.
CAUTION: Before releasing the full weight of the unit, make sure the inverter is seated properly on the mounting plate.
- 3 Secure the top of inverter with two #10 self-tapping screws (supplied).

Figure 2-6 Mounting the Xantrex XW Inverter/Charger

Step 3: Mounting the Xantrex XW Power Distribution Panel and Xantrex XW Conduit Box

Mount the Xantrex XW Power Distribution Panel on the mounting bracket following the same procedure in Step 2. When mounting the Xantrex XW Conduit Box as shown in Figure 2-7, it is not necessary to attach the front panel until all wiring is complete.

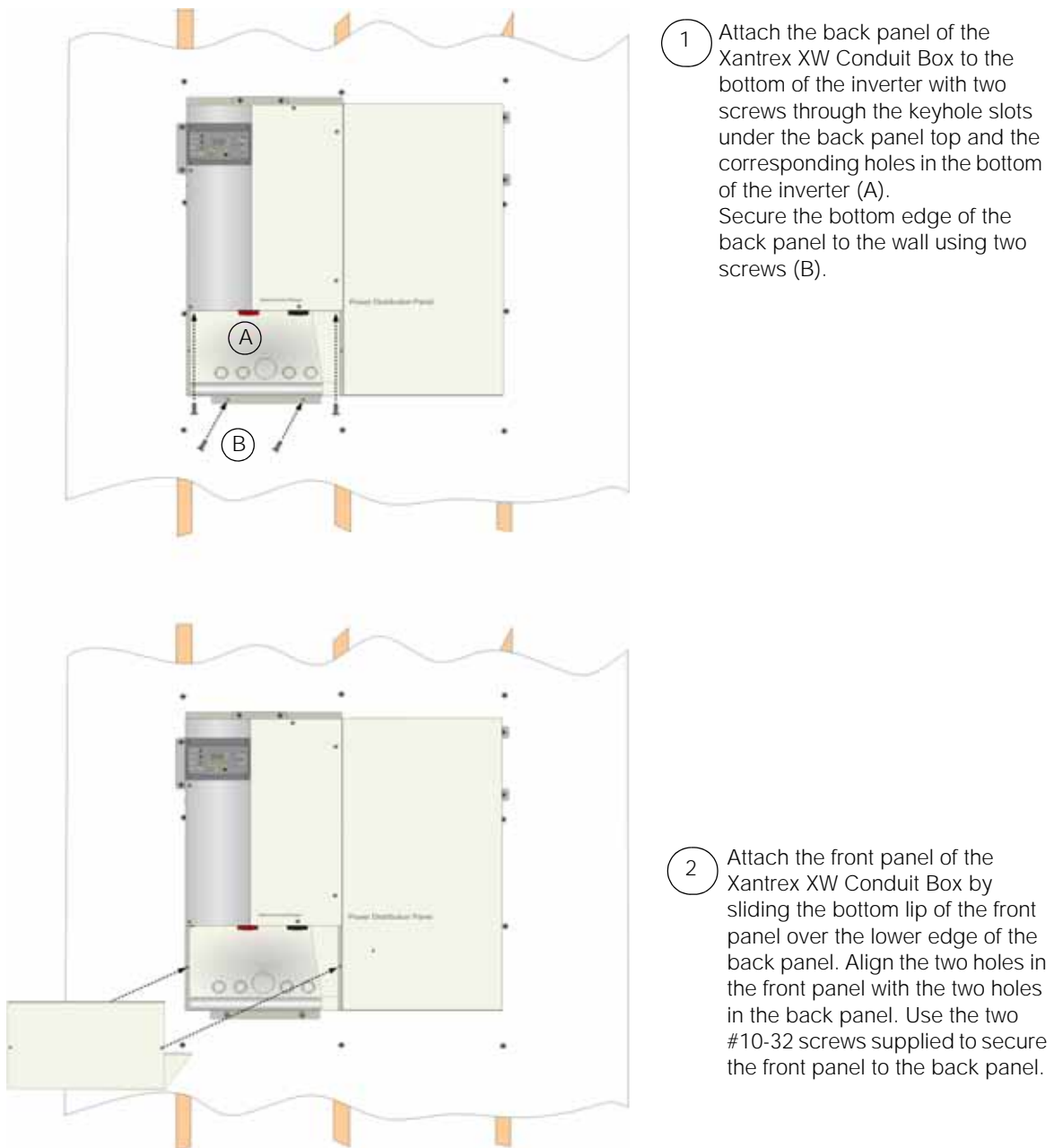

Figure 2-7 Installing the Xantrex XW Conduit Box

Step 4: Wiring the Inverter

This section provides procedures for making AC and DC connections between the Xantrex XW Inverter/Charger and the Xantrex XW Power Distribution Panel using the cables that are pre-installed in the distribution panel. This section also assumes that the Xantrex XW Conduit Box was installed in the previous section. For diagrams and information about installing the inverter/charger without the Xantrex XW Conduit Box and Xantrex XW Power Distribution Panel, see Appendix C, "Alternate System Configurations".

Important: Communication and signal cables must be segregated from all DC and AC wiring. Therefore, a small raceway has been included in the design of both the Xantrex XW Power Distribution Panel and the Xantrex XW Conduit Box to separate the communications cables from the power cables. This is a small raceway run built into the bottom of both the Xantrex XW Power Distribution Panel and the Xantrex XW Conduit Box and is held in place by a single screw at the top of the raceway.

Installation Tip

Before making the AC or DC cable connections, route the communications cables through the raceway, but do not connect them to their components until after all the inverter connections are made. Once the AC and DC connections are made the run becomes difficult to access. Use different colors for the communications cables (or cable tags) to help make them easier to identify.

Inverter/Charger Installation

Route the communications cables for any accessories being installed BEFORE making AC or DC Connections.

IMPORTANT: When routing communications cables through the Xantrex XW Power Distribution Panel, the raceway conduit must be used to keep the communications cables separate from the power cables.

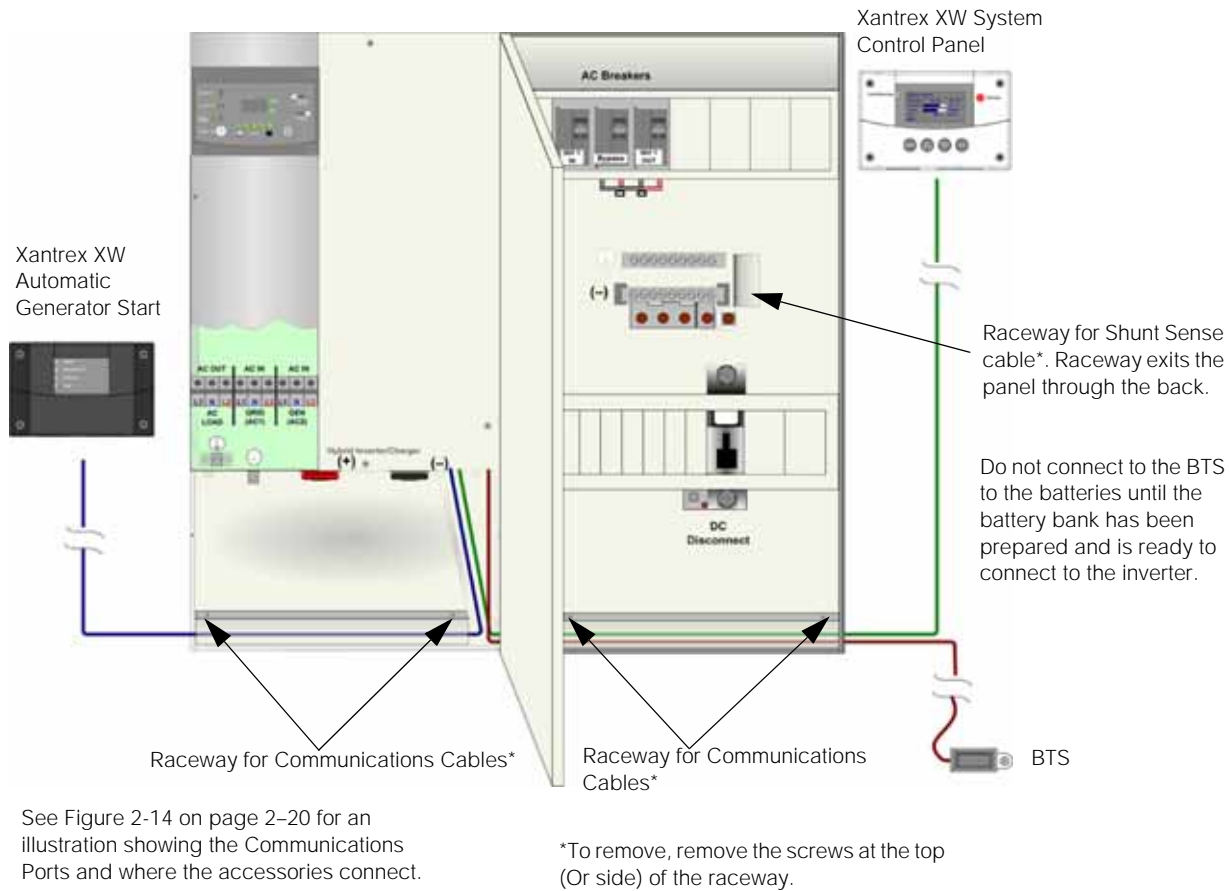

See Figure 2-14 on page 2-20 for an illustration showing the Communications Ports and where the accessories connect.

*To remove, remove the screws at the top (Or side) of the raceway.

Figure 2-8 Routing Communications Cables

Batteries

See the FAQ section of the Schneider Electric web site for information on determining battery bank requirements. Consider the following recommendations for battery use.

- Use only the deep discharge types for inverter applications.
- Use the same battery type for all batteries in the bank.
- Use only batteries from the same lot and date in your battery bank. This information is usually printed on a label located on the battery.

**CAUTION: Damage to Equipment**

The Xantrex XW Inverter/Charger is intended to operate with batteries as its source of DC power. Do not connect DC power sources, such as PV arrays, wind turbines, or micro-hydro turbines, directly to the Xantrex XW Inverter/Charger without a battery. Connect DC power sources to a charge controller such as the Xantrex XW Solar Charge Controller instead. If DC power sources are connected directly to the inverter, the DC rating of the inverter can be exceeded and the inverter can be damaged.

Battery Bank Requirements

The DC voltage of the inverter must match the nominal voltage of the system and all battery-connected devices. If the inverter is a 24 volt inverter, then the battery bank and all battery-connected devices in the system need to be configured for 24 volts.

Important: The minimum recommended battery bank is 100 Ah. The inverter is designed to operate with batteries and should not be operated without them. Also, do not allow the battery bank to become completely discharged. If the voltage of the battery bank falls below 10 volts, the Xantrex XW Power System will not operate.

Battery Cable Requirements**WARNING: Fire Hazard**

Undersized cables overheat. Always install cables with the correct ampacity in accordance with national electrical code requirements.

Important: Use only fine-stranded copper cables for battery and inverter DC connections. Do not use coarse-stranded wire, as the lack of flexibility may damage battery and inverter terminals.

Battery cable length

Runs should be kept as short as practical. Length should not exceed 10 feet (3 m). For best performance, the positive and negative cables should run alongside each other. Avoid cable loops.

Battery cable lugs

Battery cables must have crimped copper compression lugs or crimped and soldered copper compression lugs. Soldered connections alone are not acceptable. Lugs must be rated for use with fine-stranded cable.

Overcurrent protection

For safety and compliance with regulations, battery overcurrent protection is required. Fuses and disconnects must be sized to protect the wiring in the system and are required to open before the wire reaches its maximum current carrying capability.

Terminal covers

Color-coded snap-on DC terminal covers are provided to prevent accidental contact with the terminals. Terminal covers are required for all installations, even if a Xantrex XW Conduit Box is used. It is also recommended that the shank of the ring terminals (cable lugs) be covered with heat shrink or some other form of insulation.

Table 2-2 Recommended Battery Cable Size Versus Length

Inverter Model	Up to 10 Feet (3 m) (90°C wire)	
	Up to 5 Feet (1.5 m) (90°C wire)	
Xantrex XW4024 120/240 60	#4/0 AWG (120 mm ²)	#4/0 AWG (120 mm ²)
Xantrex XW4548 120/240 60	#2/0 AWG (70 mm ²)	#4/0 AWG (120 mm ²)
Xantrex XW6048 120/240 60	#4/0 AWG (120 mm ²)	#4/0 AWG (120 mm ²)

Important: The NEC/CEC requires both overcurrent protection and a disconnect switch for residential and commercial electrical systems. These items are not supplied as part of the inverter, but are included in the Xantrex XW Power Distribution Panel.

Table 2-3 Battery Cable (in Conduit) to Maximum Breaker/Fuse Size

Cable Size Required	Maximum Breaker/Fuse Size
#2/0 (00) AWG	175 amps
#4/0 (0000) AWG	250 amps

Torque Values for the Xantrex XW Series Inverter/Charger

Table 2-4 Torque Values for AC Wiring (AC Terminals and Ground Bar)

Wire Size	Torque Value	
	In-lb	N-m
14-10	35	4.0
8	40	4.5
6-4	45	5.1

Table 2-5 Torque Values for the Chassis Ground Lug

Wire Size	Torque Value	
	In-lbs	N-m
6-4	45	5.1
3-2	50	5.6

Table 2-6 Torque Values for the Inverter Battery Terminals

Torque Value	
Ft-lbs	N-m
15	20.4

Torque Values for the Xantrex XW Power Distribution Panel

Table 2-7 Torque Values for AC Disconnects and AC Breakers

Wire Size	Torque Value	
	In-lb	N-m
16-10	45	5.1
8	45	5.1
6-4	45	5.1

Table 2-8 Torque Values for the Ground Bus, AC Neutral Bus, DC Negative Bus, and DC Positive Bus in the Xantrex XW Power Distribution Panel

Wire Size	Torque Value	
	In-lbs	N-m
14 - 10	35	4.0
8	40	4.5
6 - 4	45	5.1
3 - 2/0	50	5.6

Table 2-9 Torque Values for the Power Distribution Bars in the Xantrex XW Power Distribution Panel

Wire Size	Torque Value	
	In-lbs	N-m
14 - 10	35	4.0
8	40	4.5
6 - 4	45	5.1
3 - 2/0	50	5.6

Table 2-10 Torque Values for the Battery Cables to the DC Negative Bus, and DC Positive Bus in the Xantrex XW Power Distribution Panel

Torque Value	
Ft-lbs	N-m
15	20.4

Inverter Grounding

Important: The grounding requirements vary by country and by application. All installations must comply with national and local codes. Consult local and national codes for specific grounding and bonding requirements for the desired installation.

The Xantrex XW Inverter/Charger and Xantrex XW Solar Charge Controller are provided with ground terminals that must be reliably connected to ground (protective earth) by appropriately sized equipment grounding conductors. System grounding for the AC and DC systems must be done according to code. Refer to the respective grounding information in this manual, and all applicable installation codes.

Feed-in Protection Requirements

Important: Installers must make allowance for the amount of power that can be fed into a distribution panel and the means and location for feed-in, in accordance with NEC 2008 article 690.64 or similar requirements of the local electrical code.

Wiring the Inverter to the Xantrex XW Power Distribution Panel

Important: If a Xantrex XW Conduit Box is installed, communication and Battery Temperature Sensor cables must run through the raceway at the rear of the Xantrex XW Conduit Box. Before making AC and DC connections, route all communication and Battery Temperature Sensor cables through the raceways. The raceways becomes more difficult to access after all AC and DC wiring is completed.

Grounding the DC System

The inverter's external chassis ground lug (see Figure 2-9) is used to connect the chassis of the inverter to the DC grounding system. The terminal accepts wires from #14 AWG to #2 AWG.

System grounding for the DC system, which typically involves bonding (connecting) the battery negative circuit to ground, is dependent on the system configuration. In some cases, the battery negative will be bonded to ground in other equipment such as a charge controller. If a grounded DC system is desired or required by code, make sure that the system bonding is done in one location only, and that all conductors and connections comply with applicable codes.

Actual grounding requirements may vary.

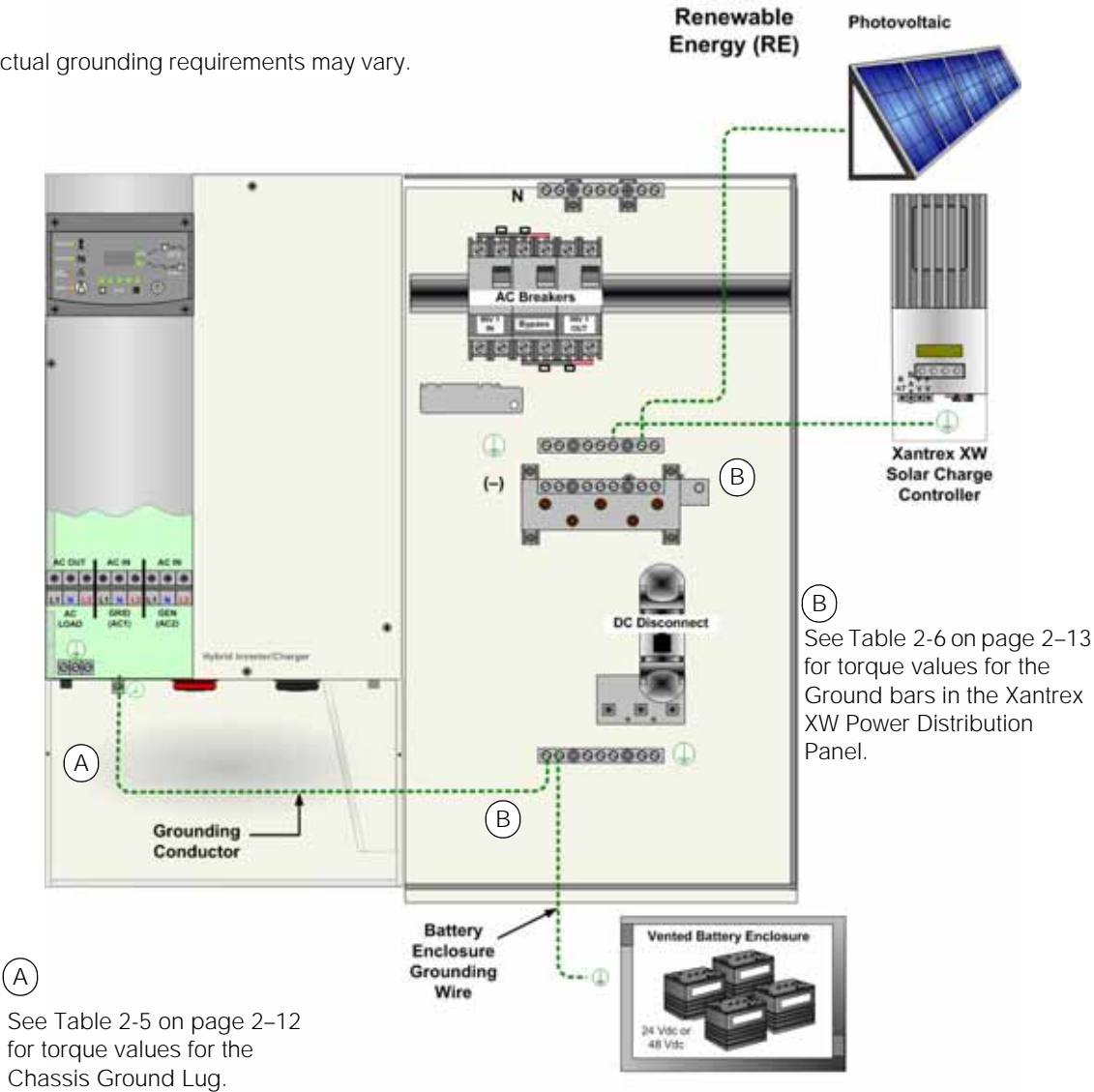

Figure 2-9 DC Grounding Using a Xantrex XW Power Distribution Panel

Installing the Battery Temperature Sensor

The Battery Temperature Sensor (BTS) port is for connecting to the Battery Temperature Sensor, which regulates battery charging based on battery temperature. Installing a sensor extends battery life by preventing overcharging in warm temperatures and undercharging in cold temperatures. This port is also considered part of the DC interface (see Figure 2-11).

To install the Battery Temperature Sensor:

1. Pass the end of the BTS cable through a conduit hole and insert the BTS plug into the BTS port.
2. Route the cable to the battery enclosure and connect the ring terminal on the BTS directly to a battery terminal (recommended), or use the adhesive backing on the sensor back to attach the sensor to any side of the battery to be monitored.

If using the adhesive backing, install the BTS on the side of the battery below the electrolyte level. It is best to place the sensor between batteries and place the batteries in an insulated box to reduce the influence of the ambient temperature outside the battery enclosure.

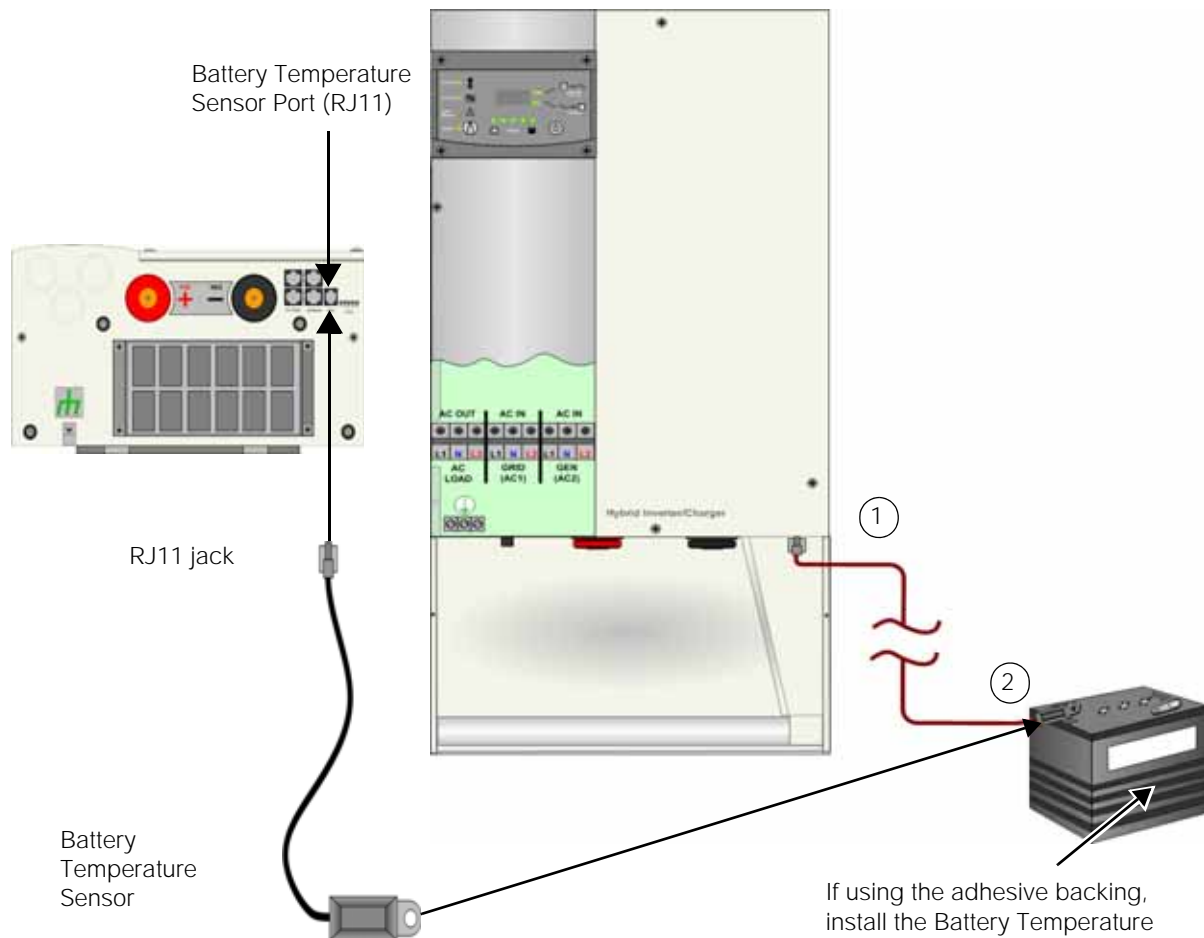

Note: If other Xantrex Xanbus connected components supply a BTS or are BTS enabled, it is not necessary to install all of them at once. Only one BTS needs to be installed.

However, if multiple battery-strings are being used to form a battery bank, multiple sensors can be installed. In this case, the system will use the highest temperature from all the inputs as its operational parameter.

Figure 2-10 Battery Temperature Sensor (RJ11) Port Location and Installation

Making DC Connections

This section describes how to make DC connections between the inverter/charger and the power distribution panel (using the pre-installed DC cables in the distribution panel) and between the distribution panel and the batteries (using battery cables provided by the installer—see Table 2-2 on page 2-12). This section also provides procedures for installing the BTS. See Appendix C, “Alternate System Configurations” if the installation will not be including a Xantrex XW Power Distribution Panel.



WARNING: Shock Hazard

Make sure all AC and DC breakers are switched OFF before connecting or disconnecting the battery cables and that all sources of power (both AC and DC) are disconnected from the inverter.

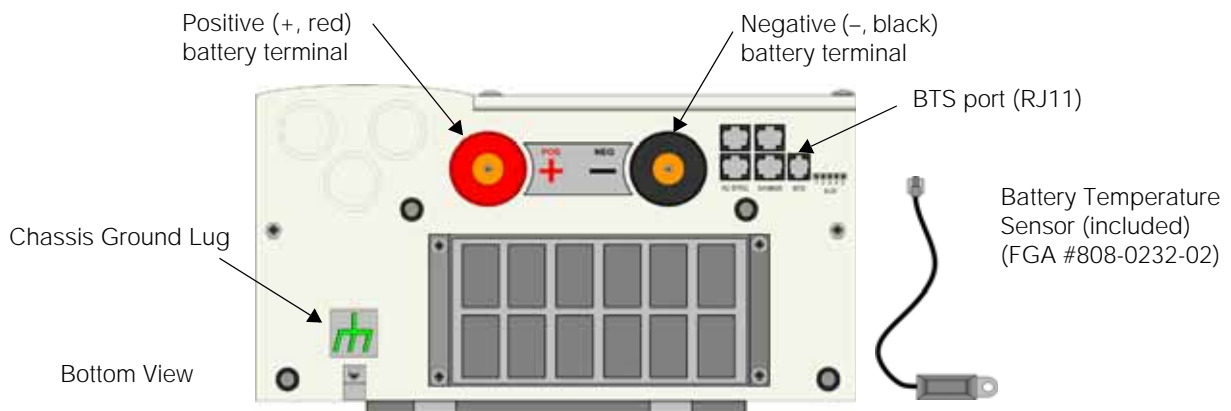

Figure 2-11 Xantrex XW Inverter/Charger DC Connections

To connect the Xantrex XW Power Distribution Panel to the inverter:

1. Connect the pre-installed DC cables from the Xantrex XW Power Distribution Panel to the inverter DC terminals. Figure 2-12 shows the proper stacking order of hardware. Be careful to observe proper polarity.
2. Attach the DC terminal covers.
3. Route the DC cables from the battery—with the cables not connected to the battery—and connect them to the Xantrex XW Power Distribution Panel: negative to negative bus, positive to the input end of the DC breaker. To properly attach and torque the positive cable to the DC breaker, you may need to temporarily remove the breaker from the rail.
4. Perform the procedures in “Making AC Connections” before connecting the DC cables from the Xantrex XW Power Distribution Panel to the battery.

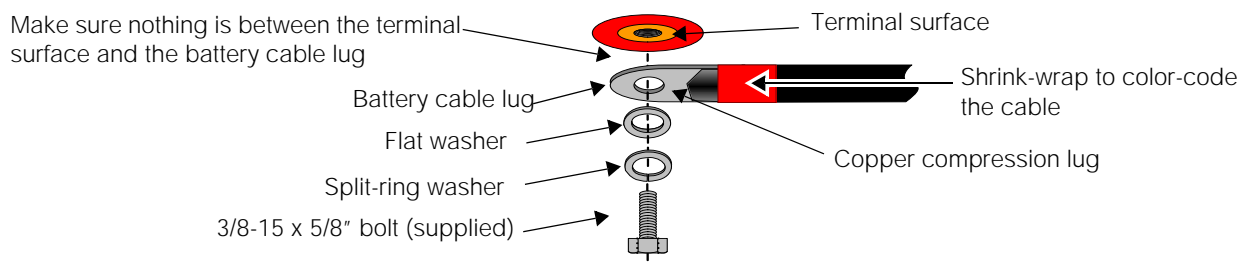

Figure 2-12 Battery Cable Connection



CAUTION: Damage to Equipment

Do not put anything between the battery cable lug and the terminal surface. Overheating of the terminal may occur. Do not apply any type of antioxidant paste until after the battery cable wiring is tightened. The same applies for all DC connections. Do not over-tighten; observe all recommended torque values.



CAUTION: Reverse Polarity Damage

Before making the final DC connection or closing the DC breaker or disconnect, check cable polarity at both the battery and the inverter/charger. Positive (+) must be connected to positive (+). Negative (-) must be connected to negative (-).

Reverse polarity damage is not covered by warranty.

Actual cable requirements may vary.

Xantrex XW Power Distribution Panel
(shown with door and front panel removed.)

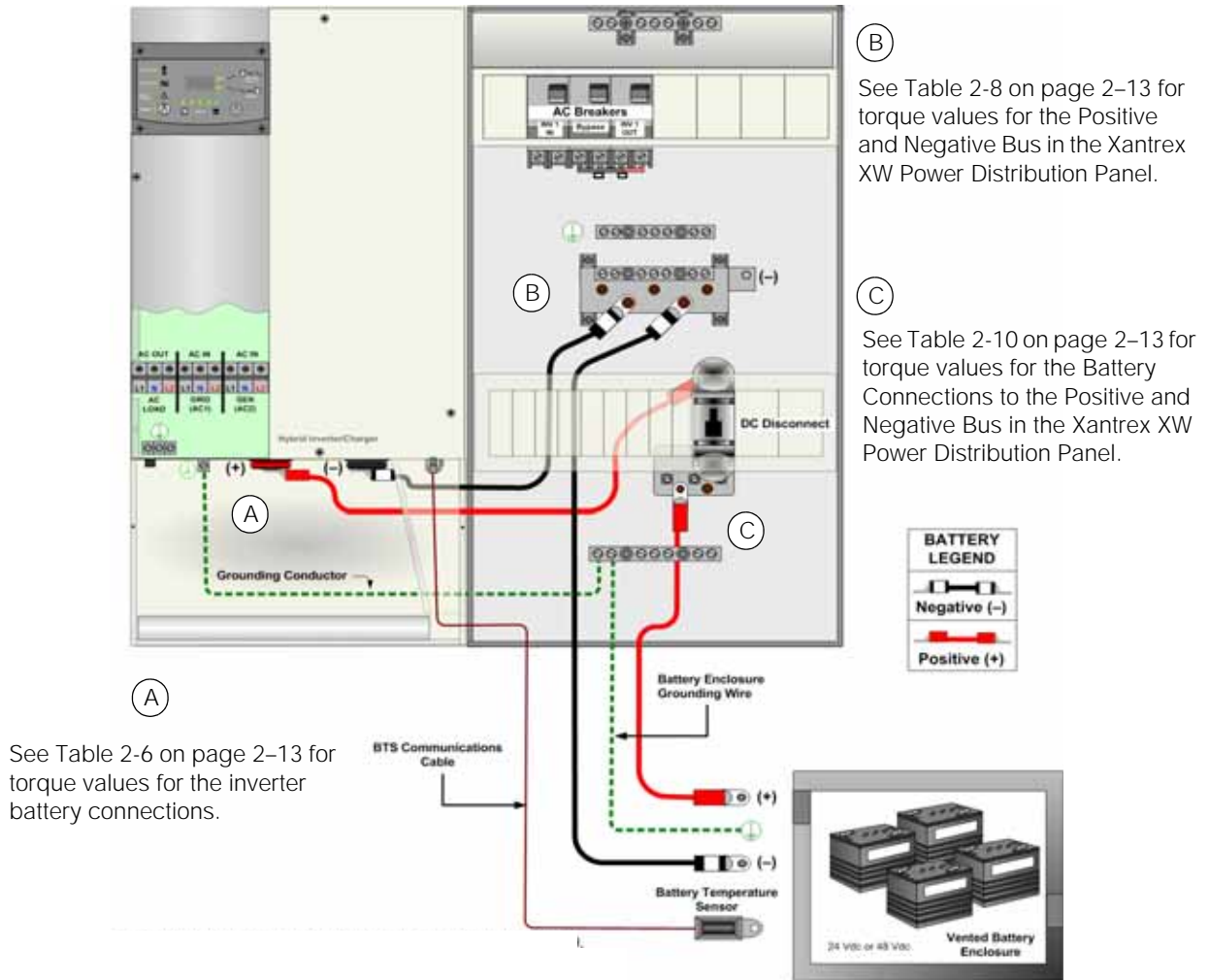

Torque connections to the battery terminals according to the battery manufacturer's recommendations.

Figure 2-13 DC Connections to a Single Inverter Using a Xantrex XW Power Distribution Panel

Making AC Connections

This section describes how to make AC connections between the Xantrex XW Inverter/Charger and the Xantrex XW Power Distribution Panel (using the pre-installed AC wiring in the Xantrex XW Power Distribution Panel) and between the Xantrex XW Power Distribution Panel and the inverter load sub-panel (using wiring provided by the installer). See Appendix C, "Alternate System Configurations" if the installation will not be including a Xantrex XW Power Distribution Panel.



CAUTION: Damage to the Inverter

The inverter's AC output must never be wired to the utility or generator output. This will cause severe damage to the inverter which is not covered under warranty.

Do not use a GFCI equipped AC source to power either the grid or generator inputs. The AC input filters on the Xantrex XW Inverter/Charger may cause nuisance tripping of ground fault protected outputs.

AC Connections and Communication Ports

AC Connections

The AC terminal block includes three terminals each (L1, L2, and Neutral) for AC Grid input, AC Generator input, and AC Load connections. The neutrals are connected to each other, requiring only one neutral connection when installed with a Xantrex XW Power Distribution Panel. Without the Xantrex XW Power Distribution Panel, additional neutral connections may be required at the input sources.

Communication Ports

Four communications ports and one AUX Port are located on the bottom of the inverter and support the following features.

- The two AC sync ports are used for connecting multiple inverters in parallel.
- The two Xantrex Xanbus ports are used for network connections between inverters, charge controllers, and accessories.
- The AUX port provides 12 VDC/250 mA output to control a relay, fan, indicator light, or other device. The auxiliary output can be configured (using a Xantrex XW System Control Panel) to trigger in response to low or high battery voltage or high or low battery temperature. The auxiliary output can also be triggered manually using a Xantrex XW System Control Panel.

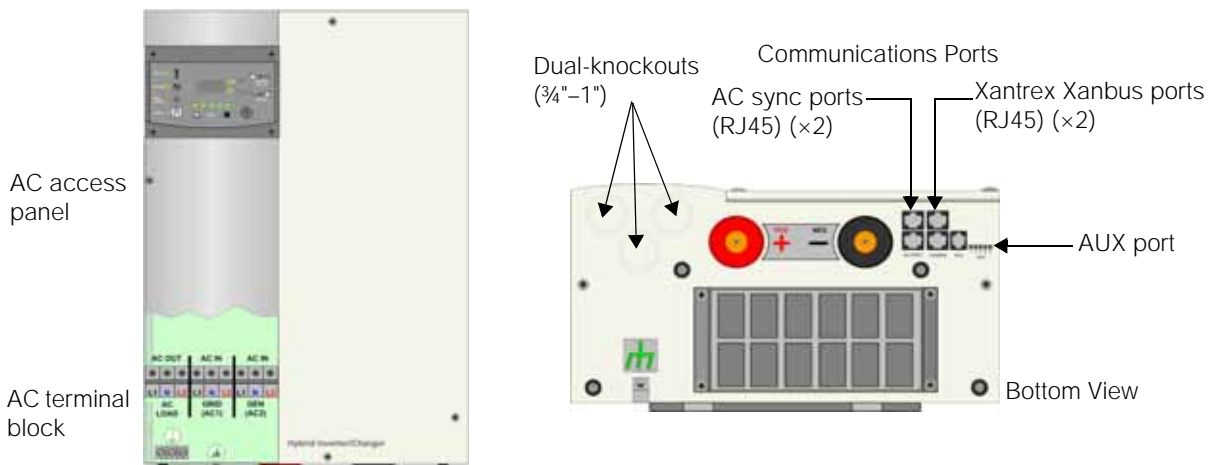

Figure 2-14 Xantrex XW Inverter/Charger AC Connections and Communications Ports

Accessing the AC Terminal Block and AC Ground Bar

All AC wiring connects to the AC terminal block located on the left side of the inverter beneath the AC access cover.

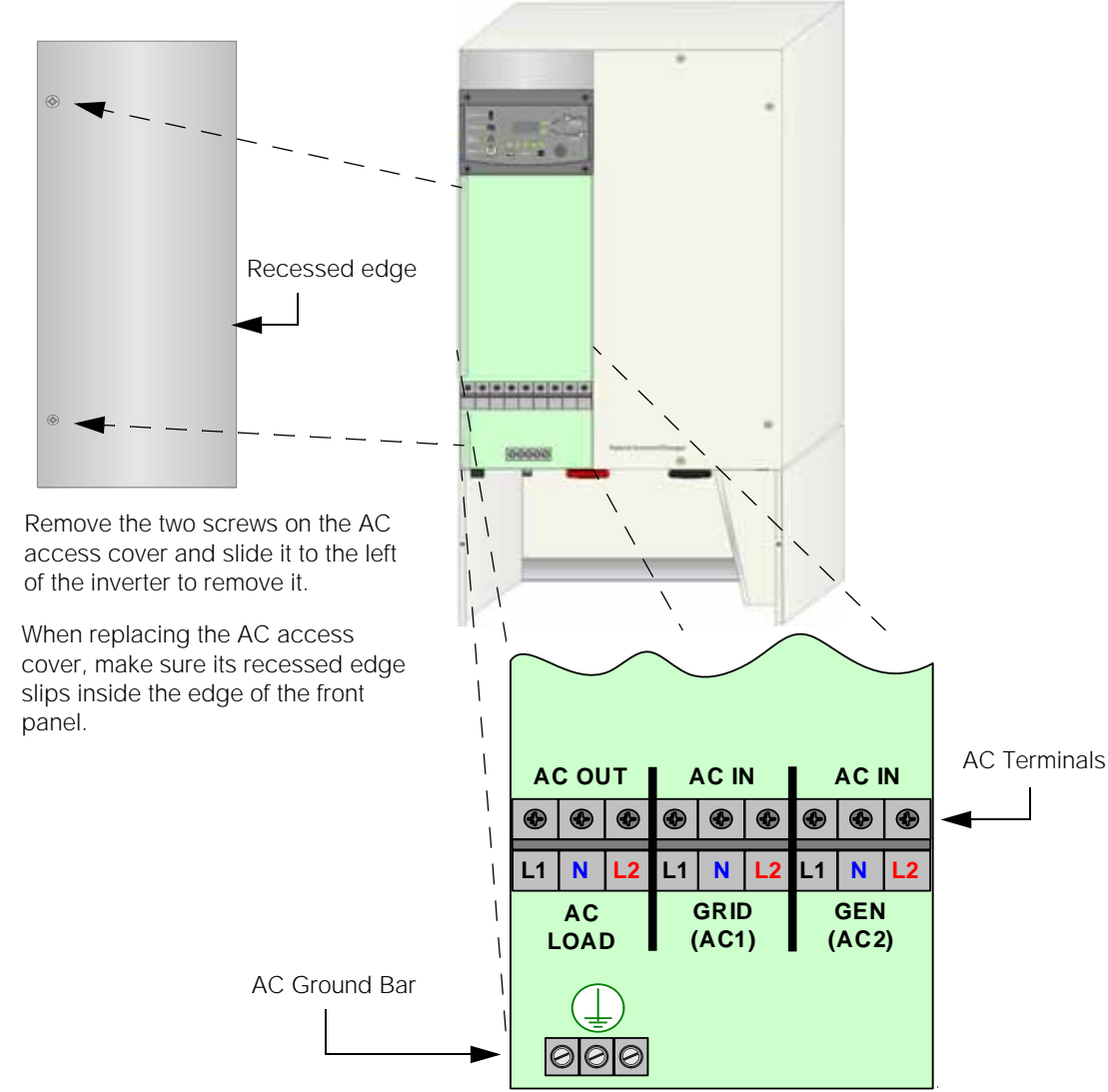
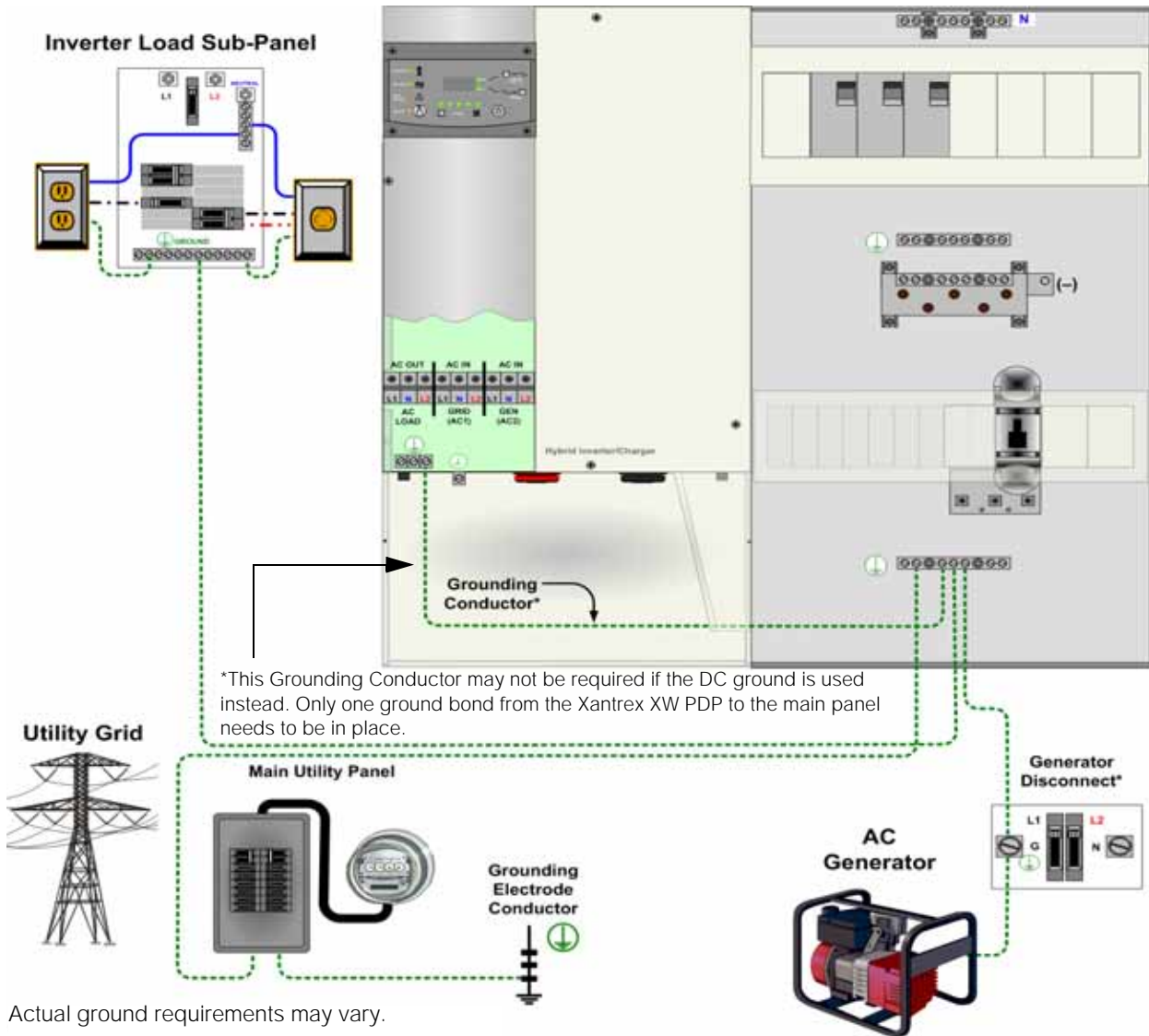

Figure 2-15 AC Terminal Block

AC Equipment Grounding

See Table 2-4 on page 12 for torque values for the AC terminal and AC Ground bar. See Figure 2-8 on page 2-13 for torque requirements for the ground bar in the Xantrex XW Power Distribution Panel.



In an off-grid installation (i.e., where no utility grid is available), the generator can be connected to the breakers supplied in the Xantrex XW Power Distribution Panel. No additional breaker is required.

* Depending on the location of the generator and local code requirements, the generator disconnect may be located in the power distribution panel.

Figure 2-16 AC Equipment Grounding Using the Distribution Panel

AC Wiring to the Inverter Load Sub-Panel

An inverter load sub-panel (also known as an inverter AC Distribution Panel) and AC conduit must be installed before AC wiring is connected to the inverter.

Install the inverter load sub-panel and conduit as follows:

1. Determine the location for the inverter load sub-panel and install it according to the manufacturer's directions.
2. Install an AC conduit between the Xantrex XW Power Distribution Panel and the inverter load sub-panel.
3. Determine which circuits the inverter will power and install the appropriate circuit breakers into the inverter panel.
4. For on-grid systems:
 - a) Disconnect all power to the main utility panel.
 - b) Determine which circuits will be backed by the inverter(s), and remove their wires from the main panel.
 - c) Reroute these wires to the new inverter sub-panel.
5. Remove unused breakers from utility panel. It is now safe to re-energize the main utility panel.
6. Install a 60 amp maximum (disconnect) main circuit breaker in the inverter panel. This will later be wired to the inverter's output.



WARNING: Shock Hazard

Before making any electrical connections, make sure all AC and DC disconnect devices are in the OPEN (disconnect) position.



CAUTION: Damage to the Inverter

The inverter's AC output must never be wired to the utility or generator output. This will cause severe damage to the inverter which is not covered under warranty.

AC System Bonding



WARNING: Fire and Shock Hazard and Risk of Equipment Damage

Verify that only one neutral-to-ground bond exists in the system. Having more than one neutral-to-ground bond in a system violates local electrical codes, may create a shock or fire hazard, and may cause some sensitive equipment to malfunction.

System bonding Refers to connection (bonding) of one of the current-carrying conductors of an electrical system to ground. This creates a "grounded conductor" or "neutral" that is at ground potential, but is separate from the equipment ground conductor. System bonding must be done in one place only to avoid ground loops, and must be done differently in on-grid and off-grid systems.

System bonding for on-grid systems

The Xantrex XW does not connect the neutral to ground. The AC input neutral is already bonded to ground by the incoming utility grid system. The installer must not connect the neutral to ground in any additional location.

The Xantrex XW does not switch or disconnect the AC neutral in any mode of operation, so even in invert (back-up) mode, the inverter load sub-panel neutral is bonded to ground by the utility grid system. It must not be grounded again in the inverter load sub-panel.

System bonding for off-grid systems

In a system without a generator, or with a generator that does not provide a grounded neutral, the connection from neutral to ground must be made by the installer in the inverter load sub-panel.

In a system with a generator that provides a grounded neutral, no additional connection from neutral to ground is needed. The installer must not connect neutral to ground in the inverter load sub-panel.

AC Wiring to the Xantrex XW Power Distribution Panel

To connect the Xantrex XW Power Distribution Panel to the inverter:

Important: The Xantrex XW Inverter/Charger is provided with fixed disconnect limits for voltage and frequency. These limits are fixed when the unit is exporting power to the grid. The unit must not be aggregated such that it can export more than 30 kW on a single point of common connection.

Important: Both lines of input power must be connected in order for the Xantrex XW Inverter/Charger to operate. For example, L1 and L2 of Grid Input and/or L1 and L2 of Gen Input need to be connected.

1. Connect the neutral wire first to the N-LOAD terminal. Connect the wires labelled INV1 N-LOAD (SPLIT PHASE), INV1 L1-LOAD, and INV1 L2-LOAD (from the L1 and L2 terminals on the input (top) side of the output breaker and the neutral bus) to the AC Load (L1-LOAD, N-LOAD, L2-LOAD) terminals on the inverter.
2. Connect the wires labelled INV1 L1-GRID and INV1 L2-GRID to the inverter. If the AC source will be the utility grid, connect to the GRID (AC1) terminals (L1-GRID, L2-GRID). If the system will be off-grid and the only AC source will be a generator, these wires can be connected to the GEN (AC2) terminals (L1-GEN, L2-GEN). No additional neutral connection is needed when using the Xantrex XW Power Distribution Panel. (Additional neutral terminals (N-GRID, N-GEN) are provided on the inverter for installations that do not use the Xantrex XW Power Distribution Panel.)
3. Connect L1 (from the L1 output Power Distribution Bar) and L2 (from the L2 output Power Distribution Bar), Neutral, and Ground to the sub-panel that supplies power to inverter loads.
4. Connect the ground wire between the Xantrex XW Power Distribution Panel and the utility grid AC panel. Connect Neutral from the Xantrex XW Power Distribution Panel to the utility grid AC panel. Connect L1 and L2 from the input side of the AC1 Breaker (L1 and L2 Power Distribution bars) to the utility grid AC Panel.

Wiring the Xantrex XW Inverter/Charger to a Xantrex XW Power Distribution Panel

Power Distribution bars in the Xantrex XW Power Distribution Panel accept up to a #2/0 AWG cable (maximum). See Figure 2-9 on page 2-13 for torque requirements.

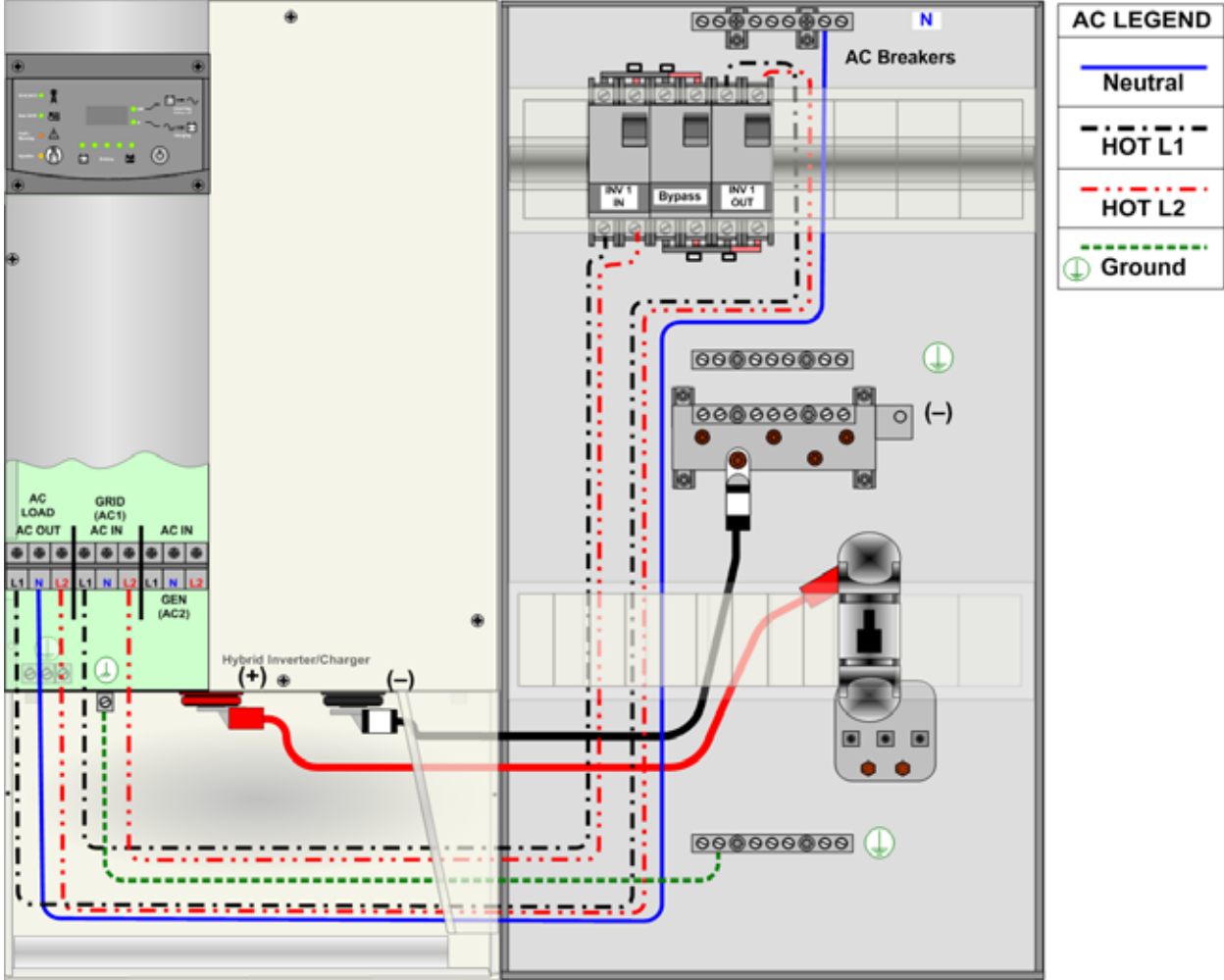

Actual wiring requirements may vary.

Figure 2-18 Wiring the Inverter to the Xantrex XW Power Distribution Panel

Generator Wiring to the Xantrex XW Inverter/Charger Using a Xantrex XW Power Distribution Panel

In an on-grid installation, the generator will require an additional AC breaker to be installed in the Xantrex XW Power Distribution Panel.

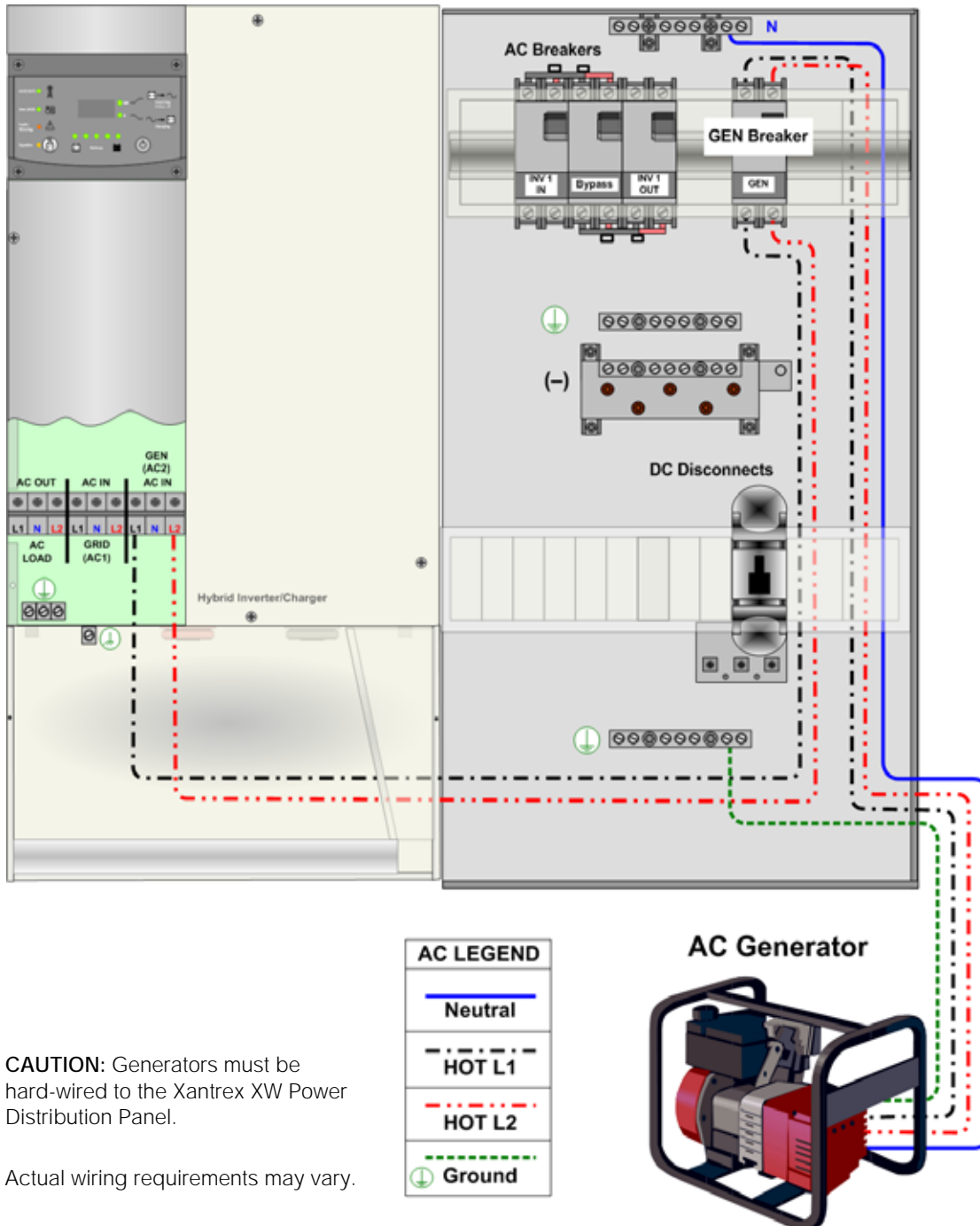

CAUTION: Generators must be hard-wired to the Xantrex XW Power Distribution Panel.

Actual wiring requirements may vary.

Figure 2-19 Generator Wiring Using a Xantrex XW Power Distribution Panel (On Grid)

In an off-grid installation, the generator can be connected to the breakers provided in the Xantrex XW Power Distribution Panel. No additional breaker is required.

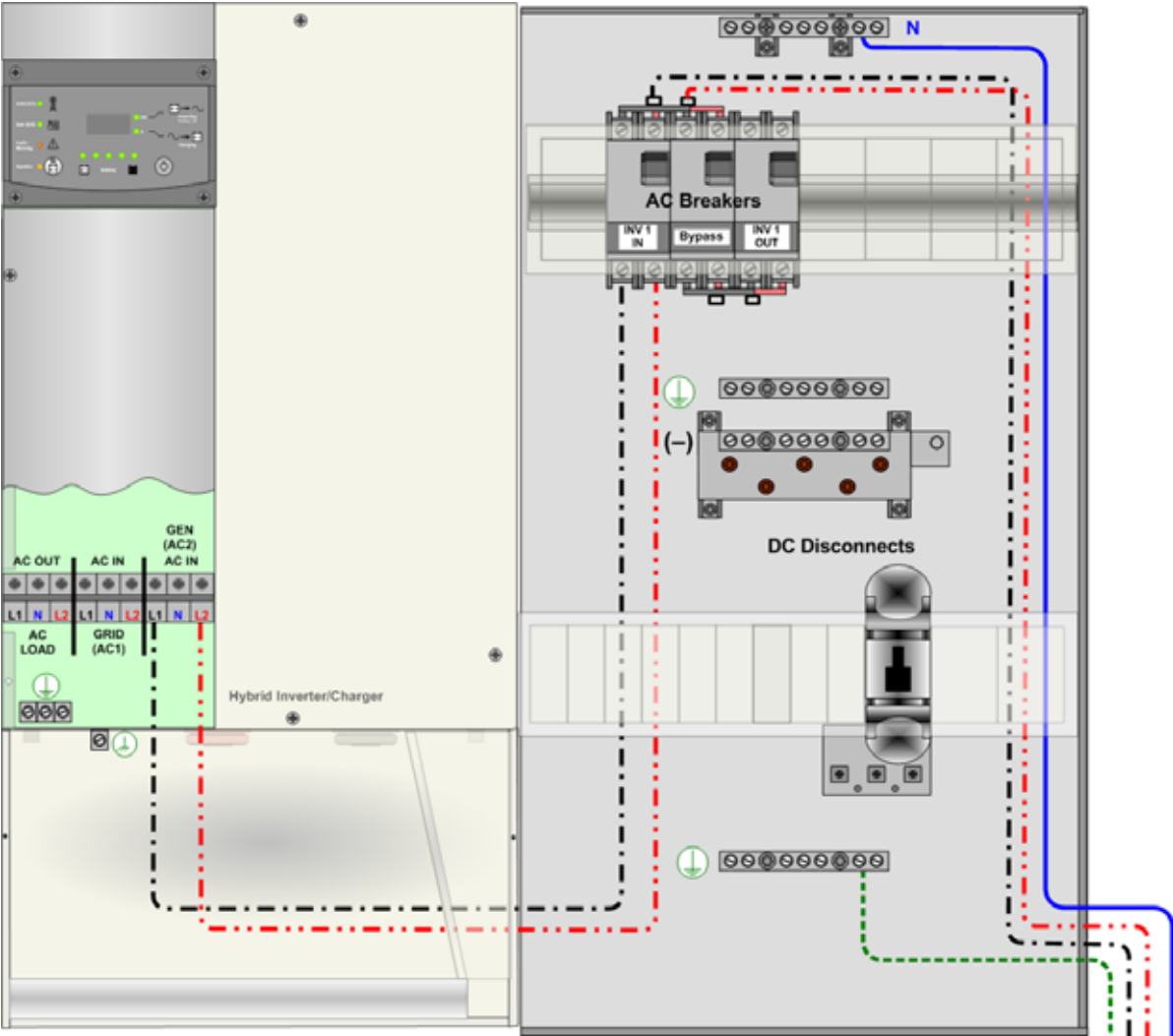

CAUTION: Generators must be hard-wired to the Xantrex XW Power Distribution Panel.

Actual wiring requirements may vary.

AC LEGEND	
	Neutral
	HOT L1
	HOT L2
	Ground

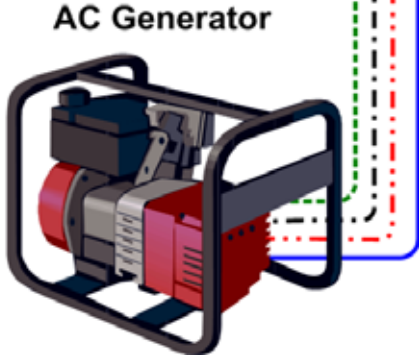

Figure 2-20 Generator Wiring Using a Xantrex XW Power Distribution Panel (Off Grid)

AUX Port

The Xantrex XW Series Inverter/Charger has a 12 VDC auxiliary output that can be configured to trigger in response to one of the following battery conditions:

- low battery voltage
- high battery voltage
- low battery temperature
- high battery temperature
- any device fault

The auxiliary output can also be triggered manually.

The 12 VDC output can be used to trigger a relay to disconnect batteries from the inverter/charger when battery voltage or temperature are out of the ideal range.

The auxiliary output is designed to provide the following functions:

- Auxiliary 12 VDC power supply
- Remote Power Off



Figure 2-21 AUX Port Location

AUX+12V Voltage Supply

DC voltage is available between JU-1 (AUX +12 V) and JU-3 (AUX-COM, signal return). The power available at these terminals is 12 VDC and maximum current is 250 mA (3 watts).

AUX+12 V and AUX-COM terminals can be used to power a relay (3 watts maximum).

Additional fuses are not required, but may be necessary for some installations.

AUX +12 V voltage supply can be programmed for different tasks ON and OFF using the Xantrex XW System Control Panel.

Default status of AUX+12 V is OFF.

AUX-RPO: User Remote Power OFF (RPO)

Connecting JU-2 (AUX-RPO) and JU-3 (AUX-COM) terminals together through an external switch (normal open contact) will provide the system shut off function if the switch is closed. The external switch, if pressed, overrides the control provided from the front panel.

To enable the AUX port remote power off function, the RPO setting must be enabled from the System Control Panel. For more information, see the *Xantrex XW Inverter/Charger Operation Guide*. If the external switch is cleared (not pressed), the system can be enabled back from the front panel.

Select an external switch with normal open contact; consult your local system designer or qualified technician for specific installation instructions.

User Line Wiring

Use twisted pairs of #24 AWG to #12 AWG for connections. Carefully route the wires away from high power load cables to minimize noise effects on signal integrity.

AUX Port Terminal Assignments

Table 2-11 User Connector Terminals and Functions

Pin	Reference	Name	Function
JU-1	AUX+12V	+12 V User Voltage Supply	+12 VDC Voltage source: 250 mA maximum
JU-2	AUX-RPO	Remote Power Off	Remote Power Off Logic Level: Active Low. Activating this signal shuts down system operation.
JU-3	AUX-COM	Common Ground Reference	Return Common Ground Reference for 12 V, Remote Power Off signals.
JU-4	Not Operational	Not Operational	Not Operational
JU-5	Not Operational	Not Operational	Not Operational

Basic Functional Test – Single Inverter

The following steps will complete a basic functional test of the Xantrex XW Inverter/Charger. If any test fails, refer to the Troubleshooting section in the *Xantrex XW Inverter/Charger Operation Guide* for assistance.

Confirm All Connections

After the AC and DC wiring have been installed and connected, check that all connections are correct and secure.



WARNING: Shock Hazard and Fire Hazard

Replace the AC access cover and all screws after the commissioning tests are complete.

Applying DC Power to the Inverter



CAUTION: Reverse Polarity Damage

Before making the final DC connection or closing the DC breaker or disconnect, check cable polarity at both the battery and the inverter/charger. Positive (+) must be connected to positive (+). Negative (-) must be connected to negative (-).

Reverse polarity damage is not covered by warranty.

To apply DC power to the inverter:

1. Before applying DC power to the inverter, measure the voltage and polarity of the cables (measure at the battery side of the disconnect or breaker).

Important: Voltage should be between 40 to 64 volts for a 48-volt system, and 20 to 32 volts for a 24-volt system. If the DC voltage is low, the battery bank must be charged externally. Charge the battery bank, and then restart the functional test.

If the DC voltage is lower than the Low Battery Cut Out (LBCO) setting (46 volts for a 48-volt system and 23 volts for a 24-volt system) a DC Under Voltage Fault (F48) will be triggered. If the DC voltage is lower than the default LBCO voltage, lower the LBCO setting accordingly to avoid triggering the fault.

If the DC voltage is lower than 40 volts for a 48-volt system or 20 volts for a 24-volt system, the battery should be charged externally.

2. Apply battery (DC) power to the inverter by closing the battery bank DC disconnect.

The inverter will power up and the display will turn on, but the inverter will remain in standby mode (as shown in Figure 2-22).

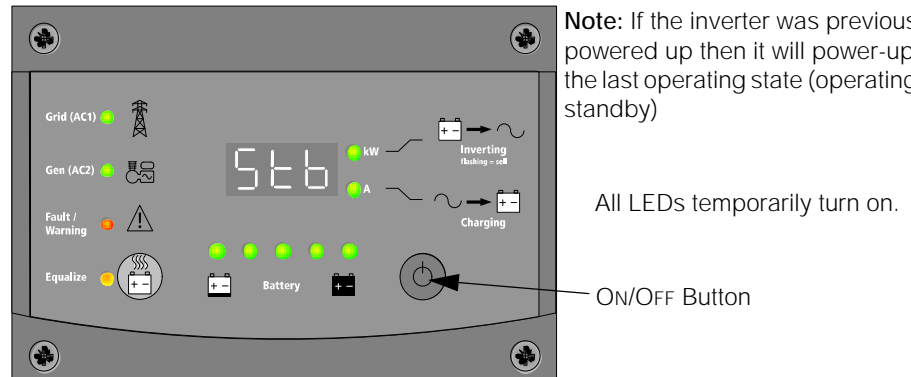

Figure 2-22 Power-up Display

Enable the Inverter



CAUTION: Equipment Damage

Prior to activating the inverter, make sure all AC loads are disconnected from the output of the inverter.

By default, invert mode is enabled and the unit should start inverting upon transitioning from standby mode. If invert mode is disabled, the display will show "---" once out of standby mode. If the unit powers up in standby mode, press the ON/OFF button momentarily to change the mode from standby to operating.

To enable the inverter:

- ◆ Press the inverter ON/OFF button and the Equalize button at the same time. E_n is briefly displayed on the inverter information panel to indicate the inverter is enabled.

To disable the inverter:

- ◆ Press the inverter ON/OFF button and the Equalize button at the same time. **dis** is briefly displayed on the inverter information panel to indicate the inverter is disabled.

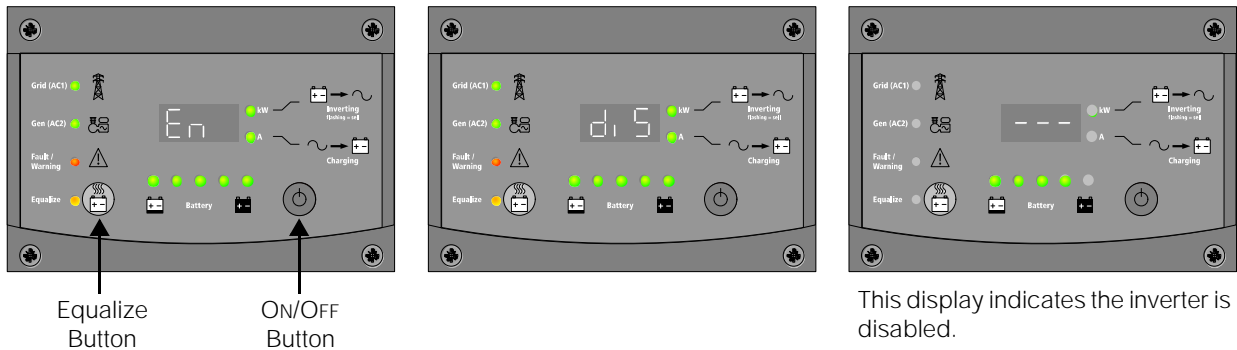

Briefly press the Equalize Button and the ON/OFF Button at the same time to enable or disable the Invert Mode.

Figure 2-23 Enable the Inverter

3. Monitor the invert (green kW) LED to confirm which mode the inverter is in:
 - LED off – Invert mode is disabled. The inverter/charger is not powering the AC loads. However, if good AC is present, it is passed through to the loads.
 - **5ch** on the display– The inverter/charger is in search mode and is looking for an AC load greater than the **Search Watts** setting (default = 25 watts). The display shows **5ch** (Search) when this mode has been enabled.
 - LED on – The inverter/charger is on. The inverter is operating and is able to provide power to the AC loads. This is the default mode on initial powerup once the unit is taken out of standby mode.

If the inverter is not operating or the inverter LED (kW) does not turn on, check all connections. Check the inverter's DC voltage on the positive (+) and negative (-) terminals. Check the Fault LED. If the fault LED is on, check for a fault code on the information panel. Correct the reported fault if possible and clear the fault. If the DC voltage is low, then the battery bank needs to be charged externally. Charge the battery bank and restart the functional test.

AC Voltage Check

Important: This test requires the use of a voltmeter.

To perform an AC voltage check:

1. With the inverter on (green kW LED is on and steady), verify the AC voltage at AC Loads block terminal L1-Load to N-Load.
2. Verify that neutral is bonded to ground in the system by measuring the hot and neutral voltages relative to ground. Neutral-to-ground should equal zero (0) volts.
3. After confirming the correct AC voltage, turn on your AC output breaker and place a load on the inverter (plug in a light or other load to an outlet the inverter is powering).
4. Confirm that the AC load that was just applied works properly.

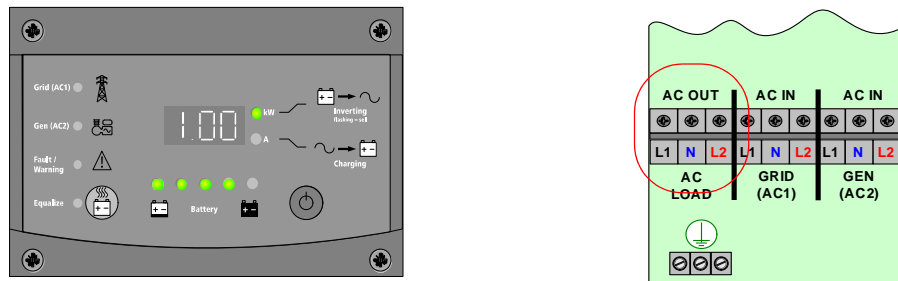

Figure 2-24 Checking AC Voltage

Confirming Battery Charger Operation

To confirm battery charger operation:

1. Apply AC from grid or generator, and confirm voltage.
2. Check LEDs (AC1 or AC2) on the front panel. One of them must be on for the unit to charge. Check the A LED. If the A LED is on, the unit is charging and the battery current is displayed on the information panel.

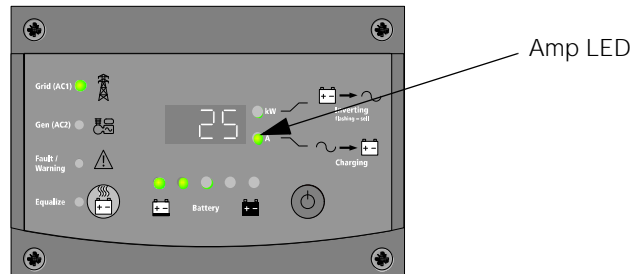

Figure 2-25 Checking Charging Operation

Important: Unless the inverter/charger settings have been changed, the inverter will charge as if it has a large (> 440 Ah) flooded battery bank (factory default setting). Therefore, ALL systems may need to have the battery charging set points fine tuned to avoid damage to the batteries.

This completes the functional test. If all tests pass, the inverter is ready for use. If any of the inverter's internal set points need to be adjusted, consult the configuration chapter of the operation guide.

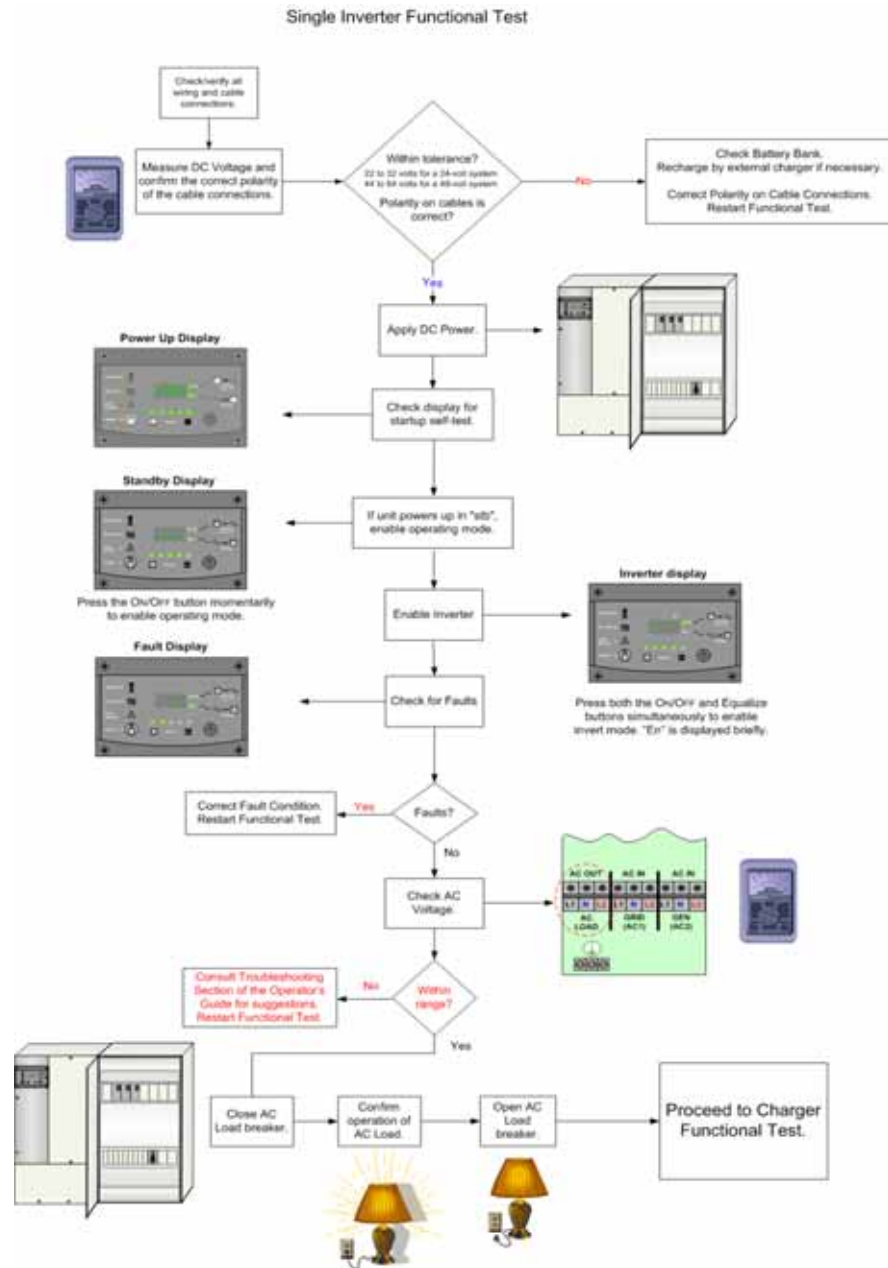

Figure 2-26 Functional Test for Single Inverter Systems

Step 5: Installing Additional Inverters

Installation Steps

To install multiple inverters:

1. Disconnect all power from the system.
2. Mount additional inverter(s). See "Step 1: Installing the Mounting Plate" on page 2-5 and "Step 2: Mounting the Inverter" on page 2-7.
3. Install the Xantrex XW Conduit Box. See "Step 3: Mounting the Xantrex XW Power Distribution Panel and Xantrex XW Conduit Box" on page 2-8.
4. Install AC sync cable(s) as required. See "Xantrex Xanbus and AC Sync Cable" on page 2-52.
5. Install a Xantrex XW System Control Panel to configure programmable settings and to name specific network components (e.g., XW1, XW2 etc.). See "The Xantrex XW System Control Panel" on page 5-2.
6. Convert the Xantrex XW Power Distribution Panel to accommodate the extra inverter by installing the additional breakers and components. See page 2-39 for instructions on converting the Xantrex XW Power Distribution Panel to a dual-inverter configuration. See page 2-45 for converting the Xantrex XW Power Distribution Panel to a triple-inverter configuration.
7. Attach Bypass interlock plate to distribution panel cover.
8. Connect DC wiring. See Figure 2-27 on page 2-40 for dual-inverter configurations and Figure 2-31 on page 2-46 for triple-inverter configurations.
9. Connect AC wiring. See Figure 2-29 on page 2-42 for dual-inverter configurations. For triple-inverter configurations, see Figure 2-32, "Triple-Inverter AC Breaker Arrangement and Wiring Enlargement with Two AC Input Sources" on page 2-48 or Figure 2-33, "Triple-Inverter AC Breaker Arrangement and Wiring Enlargement with a Single AC Input Source" on page 2-49.

Parts List for a Dual-Inverter Configuration

Installing an additional inverter using the power distribution panel requires a Xantrex XW Connection Kit for INV2 (part number 865-1020), which contains the following components:

- Xantrex XW Conduit Box
- Three 60 amp, 120/240 VAC, 2-pole, Square-D Type QOU, DIN-rail mount, AC breakers for Inverter Input, Output, and Bypass
- Four Power Distribution bars
- Custom Bypass Interlock
- #6 AWG AC wiring to connect the inverter to AC breakers

- ❑ GJ250A, 160 VDC, 3/8" Stud, DC Breaker with copper bus bar for DC positive
- ❑ One pair #4/0 battery cables to connect the inverter to DC breakers
- ❑ Xantrex Xanbus and AC Sync Cable (CAT 5 cable with RJ45 connectors wired to T568A standard).
- ❑ Miscellaneous bushings

Important: When installing more than one inverter at a location, a Xantrex XW System Control Panel is required to give each inverter (as well as other Xantrex Xanbus-enabled devices) a unique name and to modify the factory-installed default settings to match and support the installed configuration.

Converting a Single-Inverter Power Distribution Panel to a Dual-Inverter Power Distribution Panel

- ◆ Remove upper wire cover and lower wire cover on the Xantrex XW Power Distribution Panel.

DC Wiring for a Dual-Inverter System

1. Remove positive distribution plate attached to bottom terminal on existing DC disconnect/breaker.
2. Install second DC disconnect/breaker (supplied in 865-1020) next to existing DC disconnect/breaker.
3. Replace the factory-installed DC positive bus bar with the larger positive bus bar supplied in 865-1020. This larger DC positive bus bar supports up to three GJ250 ADC disconnect/breakers.
4. Connect positive battery cable for second inverter (supplied in 865-1020) to top terminal on second DC disconnect/breaker.
5. Connect negative battery cable for second inverter (supplied in 865-1020) to DC negative distribution plate.
6. Connect positive and negative battery cables to second inverter.
7. Remove knockout on the lower cover for additional disconnect/breaker to fit through.
8. Re-install lower wire cover.

AC Breakers shown in this illustration represent the breaker arrangement for a single AC source.

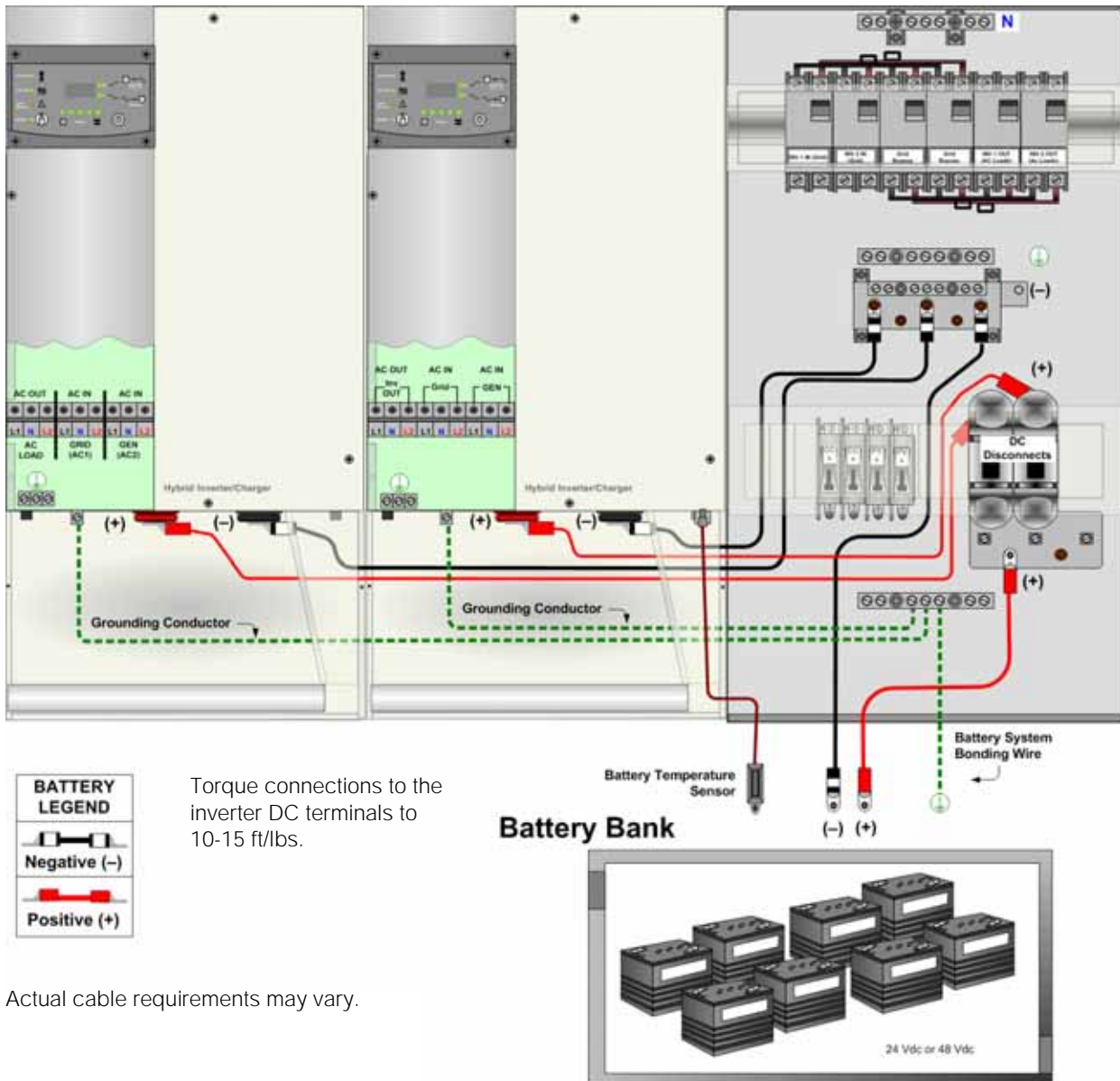

Torque connections to the inverter DC terminals to 10-15 ft/lbs.

Actual cable requirements may vary.

Torque connections to the battery terminals according to the battery manufacturer's recommendations.

Figure 2-27 DC Connections to Dual Inverters

AC Wiring for a Dual-Inverter System

1. Disconnect the AC wires (from the utility grid or generator and to the sub-panel) and remove the factory-installed distribution bars connected to top and bottom terminals on the AC breakers.
2. Remove bypass interlock bracket.
3. Disconnect INV1 AC LOAD (INV1 L1-LOAD, INV1 L2-LOAD) wires from top terminals on right-hand side breaker.
4. Add three additional dual-pole AC breakers (supplied in 865-1020) next to the existing three dual-pole AC breakers.
5. Attach the four, four-tab distribution bars (supplied in 865-1020) to top and bottom of AC breakers as shown in dual-inverter system wiring diagrams.
6. If a backup generator or other secondary AC source is installed in the system, reuse two of the dual-tab power distribution bars previously installed on INV1 Grid/Bypass breakers for generator breakers as shown Figure 2-28.
7. Connect grid wiring and loads/sub-panel wiring to the new distribution bars as shown in Figure 2-29.
8. Connect INV1 LOAD (INV1 L1-LOAD, INV1 L2-LOAD), INV2 LOAD (INV2 L1-LOAD, INV2 L2-LOAD), and INV2 GRID (INV2 L1-GRID, INV2 L2-GRID) wires to AC breakers as shown in Figure 2-29.
9. Connect neutral (INV2 N-LOAD (SPLIT-PHASE)) and ground (INV2 GROUND) wiring as shown in dual-inverter system wiring diagrams.
10. Connect wiring at the inverter/chargers as shown in Figure 2-29.
11. Remove the knockouts on upper wire cover for additional breakers to fit through.
12. Re-install upper wire cover. Re-label the AC breakers with the appropriate labels supplied with the Xantrex XW Power Distribution Panel.
13. Install the bypass interlock plate with screws and nylon shoulder washers (supplied in 865-1020).

Power Distribution bars in the Xantrex XW Power Distribution Panel accept up to a #2/0 AWG cable (maximum). See Figure 2-9 on page 2-13 for torque requirements.

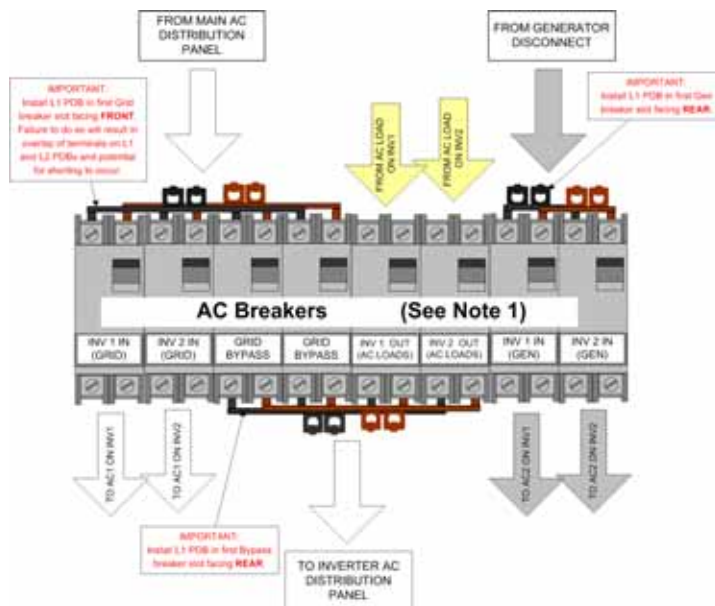
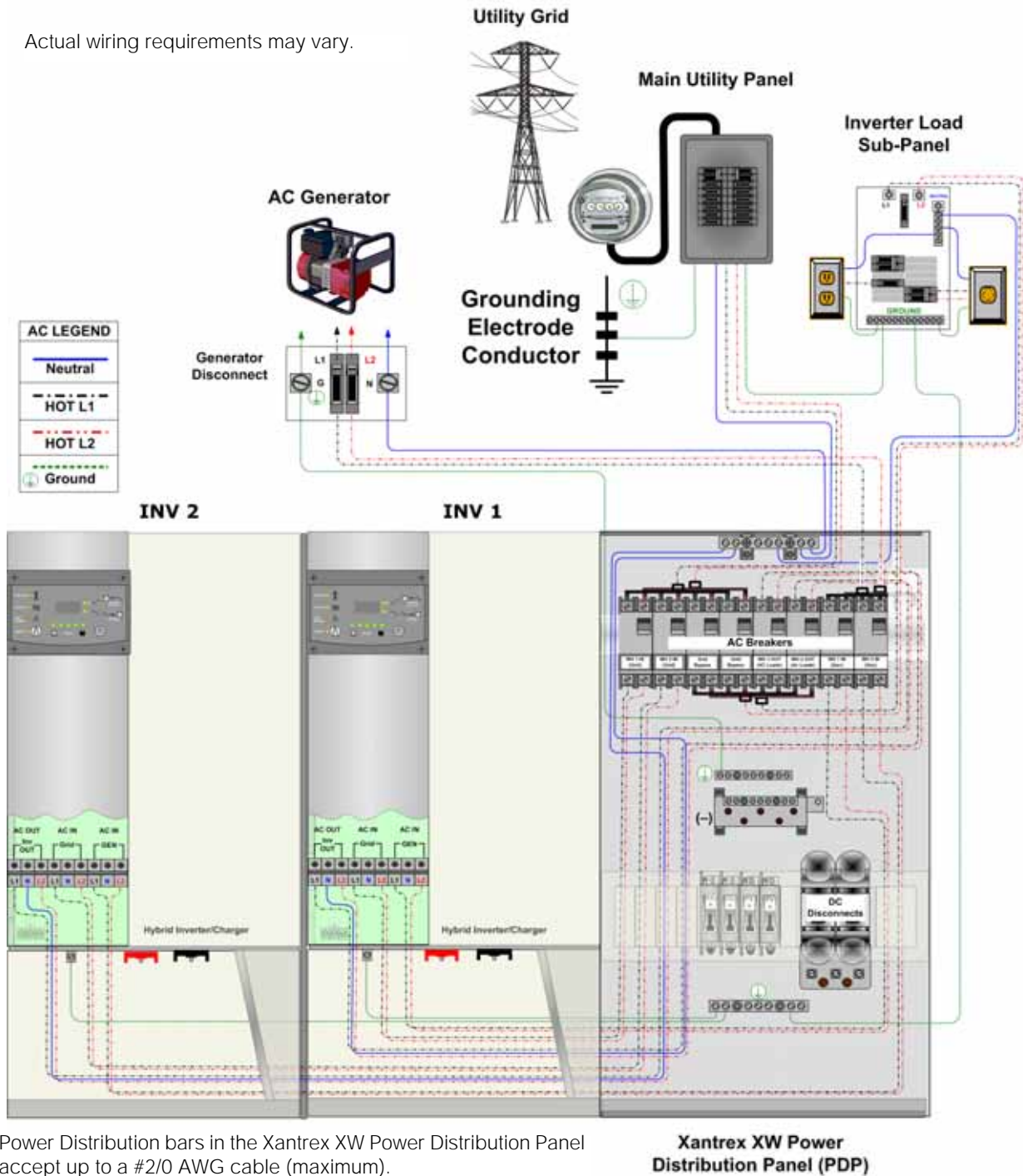

Figure 2-28 Dual Inverter AC Breaker Arrangement and Wiring Enlargement with Multiple AC Input Sources

Actual wiring requirements may vary.



Power Distribution bars in the Xantrex XW Power Distribution Panel accept up to a #2/0 AWG cable (maximum). See Figure 2-9 on page 2-13 for torque requirements.

Figure 2-29 AC Wiring for Dual-Inverter Systems

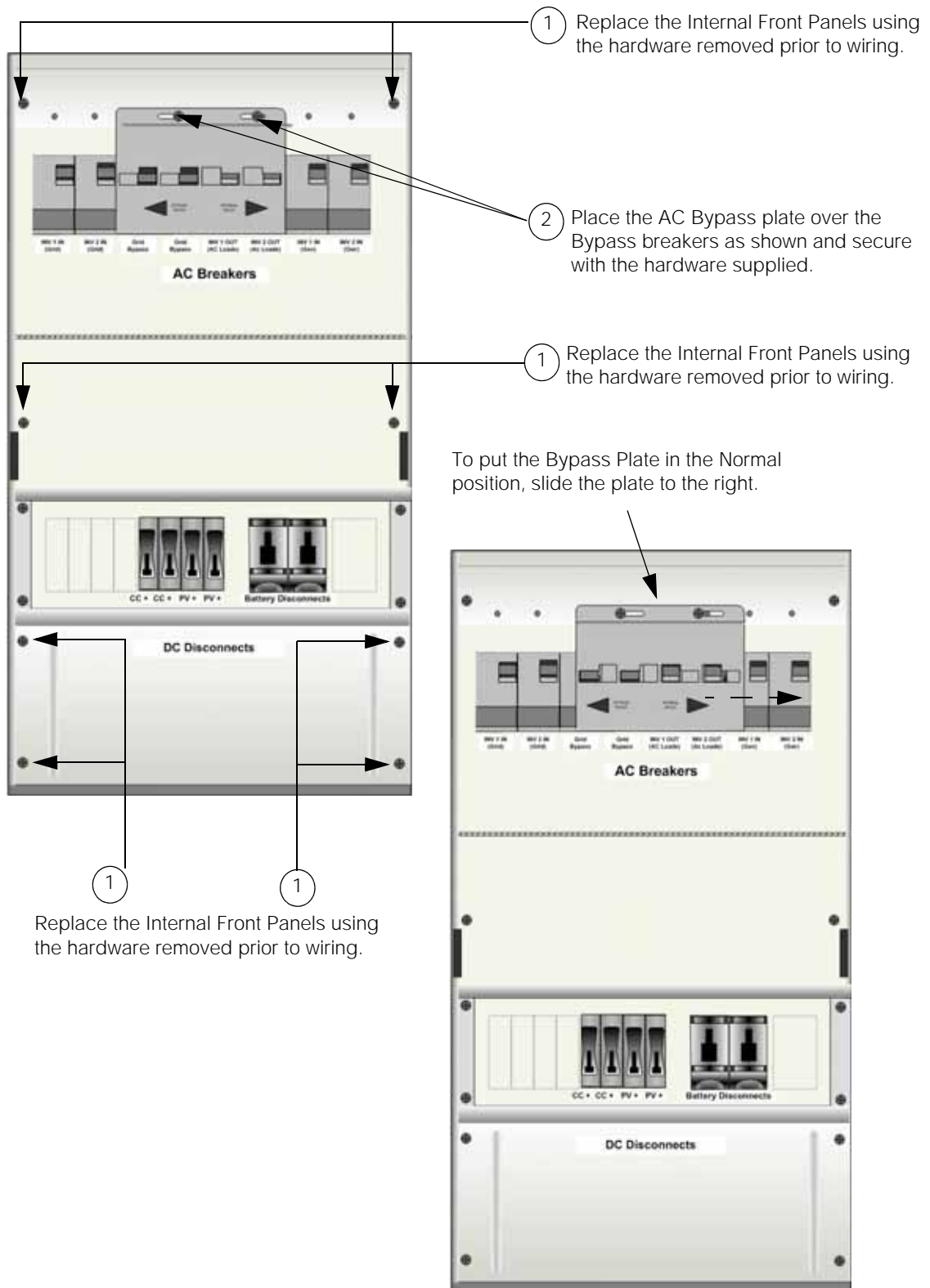

Figure 2-30 Installing the Front Internal Panels and the AC Bypass Plate

Parts List for a Triple-Inverter Configuration

- ❑ 1 x Xantrex XW Power Distribution Panel and Accessory kit (mounts to first unit).
- ❑ 1 x 865-1020 Xantrex XW Connection Kit for INV2.

The following items are required for the third inverter (furthest from Xantrex XW PDP) and should be sourced and prepared prior to the installation. (Note that all wiring will have to be custom cut to fit the third unit. Wiring supplied with the connection kit is intended for a second inverter in a two inverter system).

For an installation with a single AC input source (AC1 or AC2):

- ❑ 1 x 865-1025 Xantrex XW Conduit Box for inverter
- ❑ 1x 250 A DC breaker (Master packs available from manufacturer: part number 865-1065)
- ❑ 1.0 m (39") x CAT5 network cable for inverter AC Sync
- ❑ 1.0 m (39") x CAT5 network cable for Xantrex Xanbus communication
- ❑ 0.5m (20") x #4 AWG, 600 V, 105°C stranded green wire for ground connection

Or for an installation with two AC input sources (AC1 and AC2):

- ❑ 1 x 865-1020 Xantrex XW Connection Kit for INV2 (contains AC and DC breakers required for third inverter).
- ❑ 2.3m (91") x #6 AWG, 600 V, 105°C Black stranded wire for L1 Gen (AC2).
- ❑ 2.3 m (91") x #6 AWG, 600 V, 105°C Red stranded wire for L2 Gen (AC2).

Required in both types of installations:

- ❑ 2.2 m (87") x #6 AWG, 600 V, 105°C stranded white wire for neutral
- ❑ 2.2 m (87") x #6 AWG, 600 V, 105°C Black stranded wire for L1 Grid (AC1).
- ❑ 2.2 m (87") x #6 AWG, 600 V, 105°C Red stranded wire for L2 Grid (AC1).
- ❑ 2.3m (91") x #6 AWG, 600 V, 105°C Black stranded wire for L1 (AC2 Load).
- ❑ 2.3 m (91") x #6 AWG, 600 V, 105°C Red stranded wire for L2 (AC2 Load).
- ❑ 2.4 m (95") x #6 AWG, 600 V, 105°C Red stranded wire for AC Load.
- ❑ 1.6m (62") #4/0 AGW, 105°C, Red stranded with #4/0 x 3/8 lugs crimped at each end for the positive battery cable.
- ❑ 1.6m (62") #4/0 AGW, 105°C, Black stranded with #4/0 x 3/8 lugs crimped at each end for the negative battery cable.
- ❑ External Bypass Switch – The Xantrex XW Power Distribution Panel does not have enough breaker locations to accommodate bypass breakers in a triple-inverter system. Therefore, an external bypass switch may be needed. See Figure 2-34 on page 2-50 for an illustration of how to wire an External Bypass Switch.

Converting a Single-Inverter Xantrex XW Power Distribution Panel to a Triple-Inverter Xantrex XW Power Distribution Panel

- ◆ Remove upper wire cover and lower wire cover on the Xantrex XW Power Distribution Panel.

DC Wiring for a Triple-Inverter System

1. Install the two DC disconnect/breakers (two supplied in 865-1020).
2. Install larger, three-position positive distribution plate (supplied in 865-1020) if not already done.
3. Connect negative battery cable for third inverter (supplied in 865-1020) to DC negative distribution plate.
4. Connect negative battery cable for second inverter (custom, see material list) to DC negative distribution plate.
5. Connect positive battery cable for second inverter (supplied in 865-1020) to top terminal on second DC disconnect/breaker.
6. Connect positive battery cable for third inverter (custom, see material list) to top terminal on third DC disconnect/breaker.
7. Connect positive and negative battery cables to first inverter.
8. Connect positive and negative battery cables to second inverter.
9. Connect positive and negative battery cables to third inverter.

Power Distribution bars in the Xantrex XW Power Distribution Panel accept up to a #2/0 AWG cable (maximum). See Figure 2-9 on page 2-13 for torque requirements.

AC Breakers shown in this illustration represent the breaker arrangement for multiple AC sources.

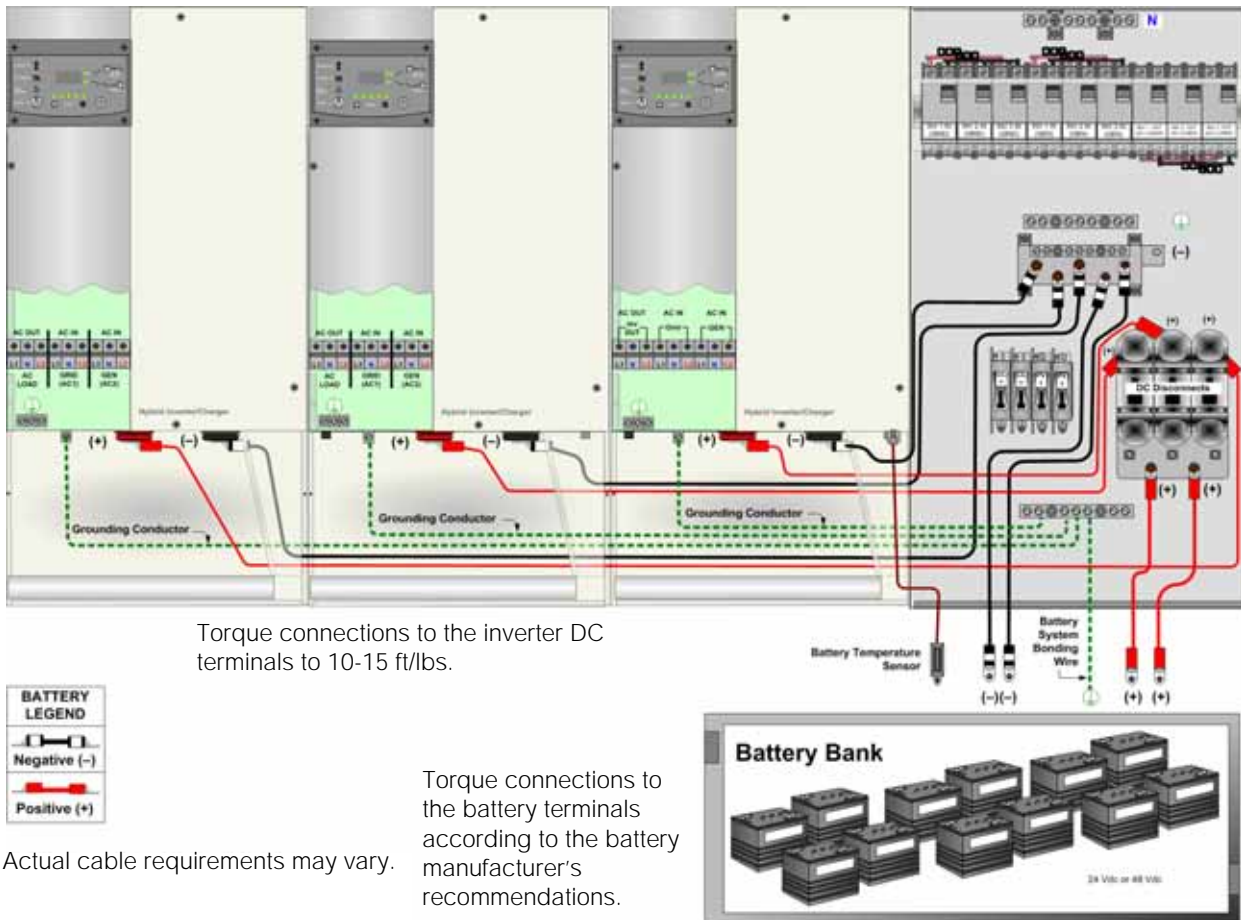

Figure 2-31 DC Connections for a Triple-Inverter System

AC Wiring for a Triple-Inverter System

1. Prepare power distribution bars by cutting away one of the four tabs. Only three tabs per power distribution bar are required in a three inverter system. The power distribution bars are supplied in 865-1020. You should have a total of:
 - four distribution bars for an installation with a single AC input source (AC1 or AC2)
 - six distribution bars for an installation with two AC input sources (AC1 and AC2)

2. Mount the nine breakers on the din rail and install power distribution bars as follows (refer to figures 2-28 & 2-29):
 - a) Two distribution bars, L1, and L2 at the input (top) terminals of the INV1, INV2, and INV3 Grid breakers.
 - b) If the installation includes a second AC source, install two distribution bars, L1, and L2 at the input (top) terminals of the INV1, INV2, and INV3 Gen breakers.
 - c) Two distribution bars, L1, and L2 at the output (bottom) terminals of the INV1, INV2, and INV3 AC Load breakers.
3. Connect L1 and L2 AC wiring from each INV Grid breaker to the corresponding AC Input (AC1) terminal on each of the three inverters. For information on where you can get the L1 and L2 wiring for each inverter, see Table 2-12 on page 2-48.
4. If the installation includes a second AC source, connect L1 and L2 AC wiring from each INV Gen breaker to the corresponding AC Input (AC2) terminal on each of the three inverters. For information on where you can get the L1 and L2 wiring for each inverter, see Table 2-12 on page 2-48.
5. Connect L1 and L2 AC wiring from each INV AC Load terminal from each of the three inverters to the corresponding AC INV Out breaker terminal in the Xantrex XW PDP.
6. Connect L1 and L2 AC Load wiring to the INV Out (AC Load) power distribution bar.
7. If the installation includes a second AC source, connect L1 and L2 AC wiring from the Generator (or other source) disconnect to the Gen breaker power distribution bars.
8. Connect L1 and L2 AC wiring from the Utility Grid distribution panel to the Grid breaker power distribution bars.
9. Connect the neutral wiring from INV1, INV2, and INV3 to the neutral distribution bar in the PDP. For information on where you can get the neutral wiring for each inverter, see Table 2-12 on page 2-48.
10. Connect the ground wiring from INV1, INV2, and INV3 to the ground distribution bar in the PDP. For information on where you can get the ground wiring for each inverter, see Table 2-12 on page 2-48.

Table 2-12 Wiring Components and Part Numbers

Wiring	Kit	Part Number
INV1 <ul style="list-style-type: none"> • AC wiring for AC1 and AC2 • neutral wiring • ground wiring 	Xantrex XW Power Distribution Panel	865-1015
INV2 <ul style="list-style-type: none"> • AC wiring for AC1 and AC2 • neutral wiring • ground wiring 	Xantrex XW Connection Kit for INV2	865-1020
INV3 <ul style="list-style-type: none"> • AC wiring for AC1 and AC2 • neutral wiring • ground wiring 	Custom, see “Parts List for a Triple-Inverter Configuration” on page 2–44.	

Power Distribution bars in the Xantrex XW Power Distribution Panel accept up to a #2/0 AWG cable (maximum). See Figure 2-9 on page 2–13 for torque requirements.

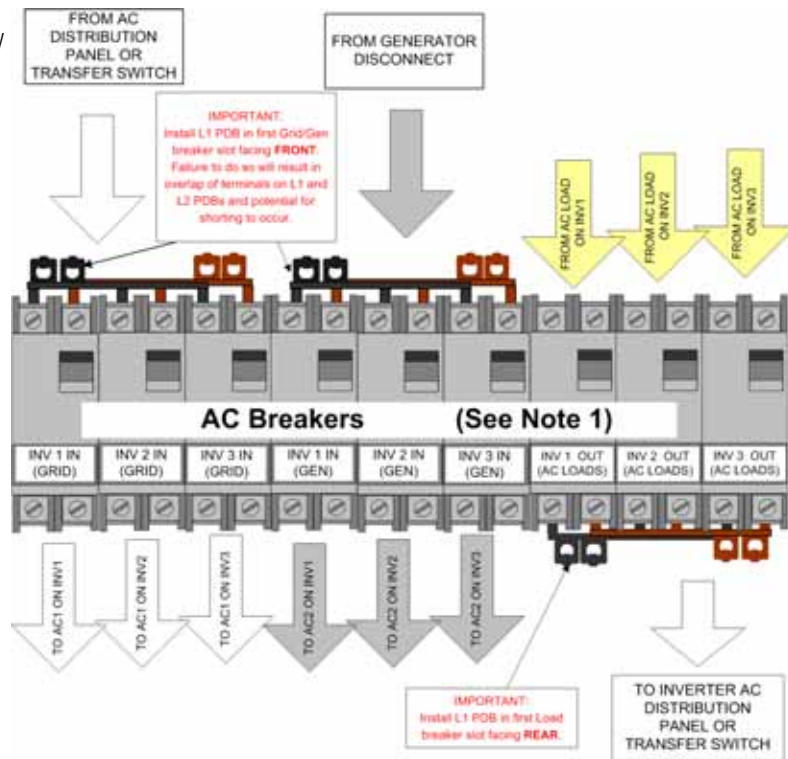

Figure 2-32 Triple-Inverter AC Breaker Arrangement and Wiring Enlargement with Two AC Input Sources

Power Distribution bars in the Xantrex XW Power Distribution Panel accept up to a #2/0 AWG cable (maximum). See Figure 2-9 on page 2-13 for torque requirements.

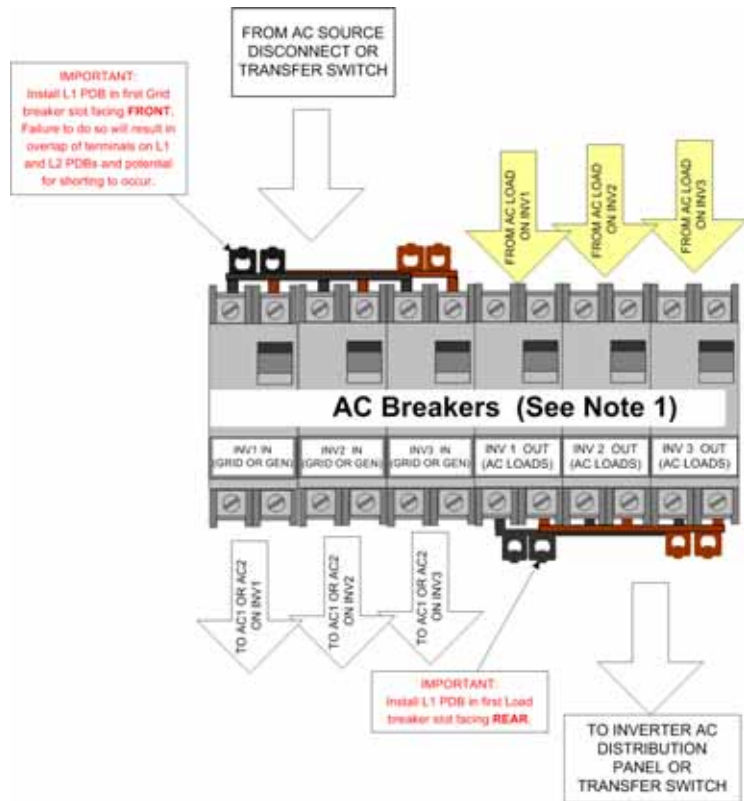

Figure 2-33 Triple-Inverter AC Breaker Arrangement and Wiring Enlargement with a Single AC Input Source

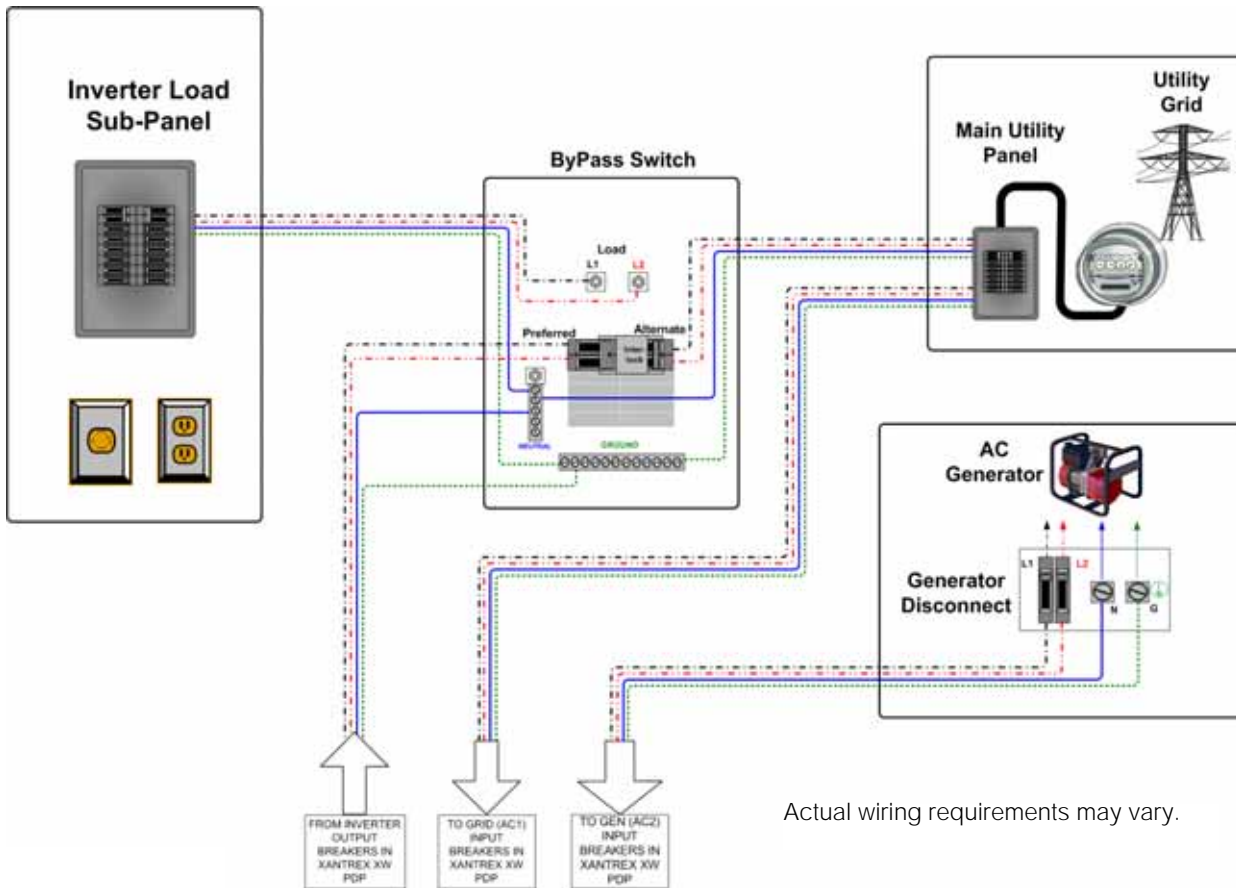

Figure 2-34 Wiring an External Bypass Switch for a Triple-Inverter Configuration

Parts List for a Four-Inverter System

Installing four inverters using two power distribution panels requires the following:

- ❑ 2 x Xantrex XW Power Distribution Panel Kit (part number 865-1015)
For a list of components included in this kit, see “Xantrex XW Power Distribution Panel and Xantrex XW Conduit Box” on page 1–4.
- ❑ 2 x Xantrex XW Connection Kit (part number 865-1020).
For a list of components included in this kit, see “Xantrex XW Connection Kit for INV2” on page 1–6

Important: When installing more than one inverter at a location, a Xantrex XW System Control Panel is required to give each inverter (as well as other Xantrex Xanbus-enabled devices) a unique name and to modify the factory-installed default settings to match and support the installed configuration.

Installing a Four-Inverter System

Installing a four-inverter system involves converting each Xantrex XW Power Distribution Panel to a dual-inverter power distribution panel. For the purpose of this procedure, the two power distribution panels will be called Xantrex XW PDP1 and Xantrex XW PDP2 respectively.

At the end of this procedure, you will have two sets of dual-inverter systems, having the following connections:

- INV1 and INV2 connected to Xantrex XW PDP1
- INV3 and INV4 connected to Xantrex XW PDP2.
- The inverter load sub-panel of Xantrex XW PDP1 connected to the inverter load sub-panel of Xantrex XW PDP2

For a visual aid, see “AC Wiring for a Four-Inverter System” on page B-9.

To install a four-inverter system:

1. Remove the upper wire cover and lower wire cover from Xantrex XW PDP1.
2. Connect DC wiring from INV1 and INV2 to Xantrex XW PDP1. See “DC Wiring for a Dual-Inverter System” on page 2-39.
3. Connect AC wiring from INV1 and INV2 to Xantrex XW PDP1. See “AC Wiring for a Dual-Inverter System” on page 2-41.
4. Repeat the steps above to connect AC and DC wiring from INV3 and INV4 to Xantrex XW PDP2.
5. Connect LI from Xantrex XW PDP1’s inverter load sub-panel to Xantrex XW PDP2’s inverter load sub-panel.
6. Connect L2 from Xantrex XW PDP1’s inverter load sub-panel to Xantrex XW PDP2’s inverter load sub-panel.

Xantrex Xanbus and AC Sync Cable

A Xantrex Xanbus and AC sync cable is required for multi-unit installation. The AC sync cable connects each inverter and provides the necessary communication and control between multiple units. Install these cables, routing them through the Xantrex XW Conduit Box raceway, prior to making the AC and DC wiring connections. See Figure 2-35.

To install the AC Sync and Xantrex Xanbus cables between inverters:

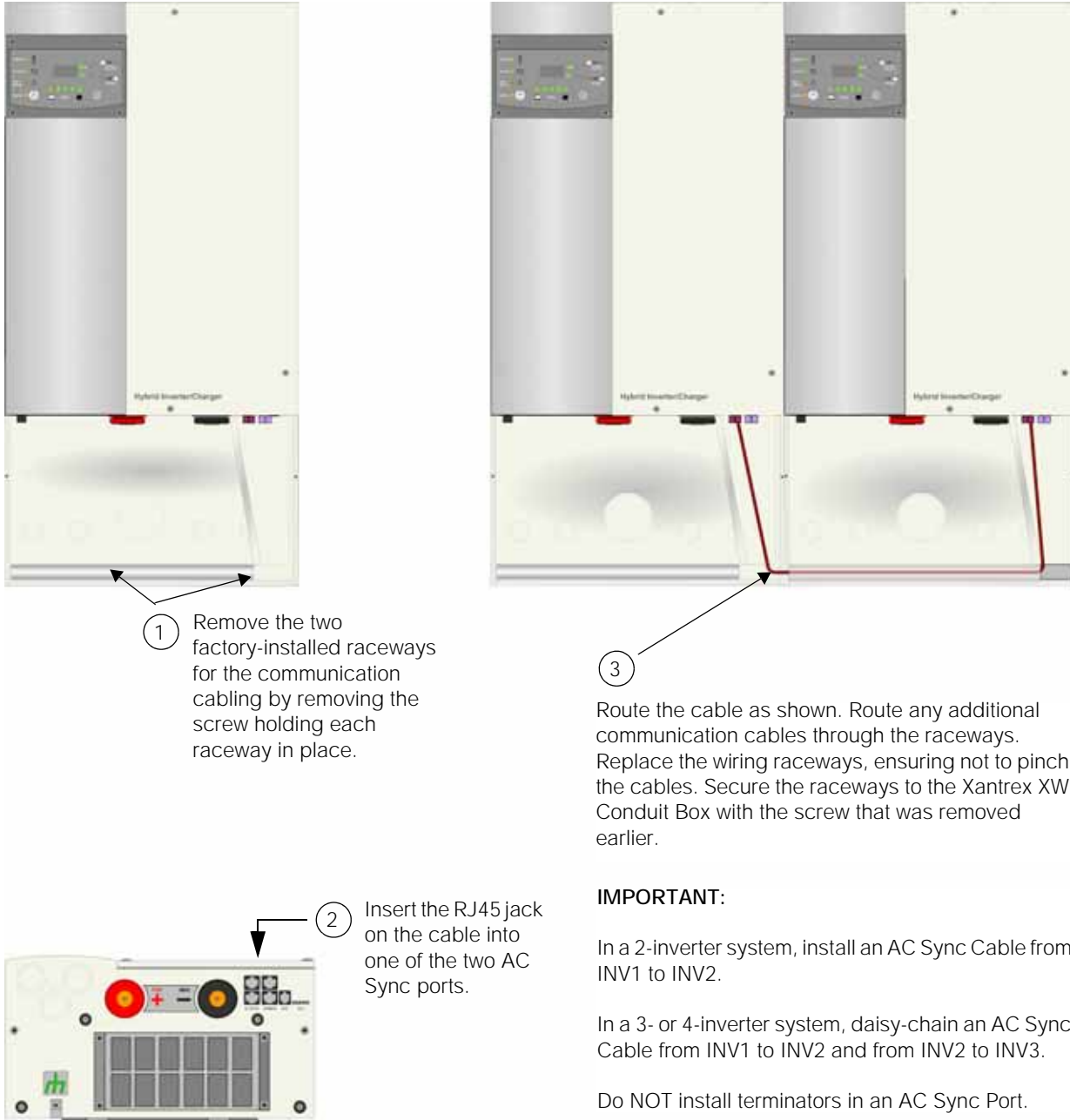

Figure 2-35 Installing the AC Sync Cable

Basic Functional Test - Multiple Inverters

The following steps will complete a basic functional test of multiple Xantrex XW Inverter/Chargers. If any test fails, please refer to the Troubleshooting section in the *Xantrex XW Inverter/Charger Operation Guide* for assistance.

To perform a functional test on multiple inverters:

1. Check/verify all wiring and cable connections.
2. Measure DC voltage at the DC terminals on the inverter and confirm its within range and has correct polarity. The default acceptable range is 23 to 32 VDC for 24 V systems or 46 to 64 VDC for 48 V systems.
3. Switch INV1 DISCONNECT to the ON position.
4. Check inverter display for startup self-test during which all LEDs will flash momentarily. Once self-test is complete, the inverter will display **5**b****. (The Fault/Warning LED may flash for a few seconds but eventually will turn off. If Fault/Warning LED persists, check to make sure a battery temperature sensor is connected. Also, if the inverter has been pre-configured, it may go straight into normal operating mode.)
5. Using the Xantrex XW System Control Panel, set the First (Master) Inverter Device Number:
 - a) Go to the inverter's **Advanced Settings** menu by pressing Down arrow + Enter from the **System Status** screen and then simultaneously pressing Enter + Up arrow + Down arrow.
 - b) Select **Multi Unit Config** menu.
 - c) Change **Dev Number** from 00 to 01. The inverter will now appear as XW6048-01 in the device list.
 - d) Press Exit to go back to the **System Status** screen.
6. Switch INV2 DISCONNECT to the ON position.
7. Check inverter display for startup self-test during which all LEDs will flash momentarily. Once self-test is complete, the inverter will display **5**b****. (If the inverter has been pre-configured, it may go straight into normal operating mode or display F66 warning.)
8. Using the Xantrex XW System Control Panel, set the Second (Slave) Inverter Device Number and Inverter Mode:
 - a) Select the new inverter, XW6048-00, in the device list.
 - b) Go to the inverter's **Advanced Settings > Multi-Unit Config** menu.
 - c) Change **Dev Number** from 00 to 02 (or the next number that has not been used). The inverter will now appear as XW6048-02 in the device list.
 - d) Change **Invtr Mode** from **SplitPhMaster** to **SplitPhSlave**.
 - e) Press Exit until you see the **System Status** screen.
9. Check for faults. If fault condition(s) exist, correct and restart Functional Test.
10. If a third inverter is installed, repeat steps to configure it as a Slave.

11. Using the Xantrex XW System Control Panel, enable the system:
 - a) Go to the `System Settings` menu.
 - b) Change `System Mode` to `Operating`.
 - c) Press `Exit` until you see the `System Status` screen.
12. Confirm the Master inverter displays `0.00` and the Slaves displays `---` on their front panels.
13. Check for faults. If fault condition(s) exist, correct, and then restart Functional Test.
14. Check voltage at AC LOAD terminals of the Master inverter.
15. Switch the AC Load breakers ON.
16. Confirm operation of connected AC loads.
17. Disconnect AC LOAD breakers.
18. Using the Xantrex XW System Control Panel, reduce maximum charge rate.
 - a) From the `System Status` screen, go to `System Settings` and enable `Cascading` (if not enabled). With `Cascading` enabled, a change to a setting in one inverter will automatically ripple through to the other inverter(s) in the system.
 - b) Go to `Advanced Settings > Charger Settings` in one of the inverters.
 - c) Set `Max Chg Rate` to 10%.
 - d) Press `Exit` until you see the `System Status` screen.
19. Switch AC input breakers ON.

Note: All inverters in the system must be connected to the same AC input source before they will qualify the source.
20. Confirm both inverters start charging.

Note: With `Max Chg Rate` set to 10% the maximum charge rate is limited to 10 A on each inverter. Depending on the battery bank's state-of-charge, the output from one or more inverters may quickly drop to zero. This is considered normal operation.
21. Check for faults. If fault condition(s) exist, correct, and then restart Functional Test.

If the Inverters pass the Functional Test, proceed to the Commissioning procedure as defined in *Xantrex XW Inverter/Charger Operation Guide*.

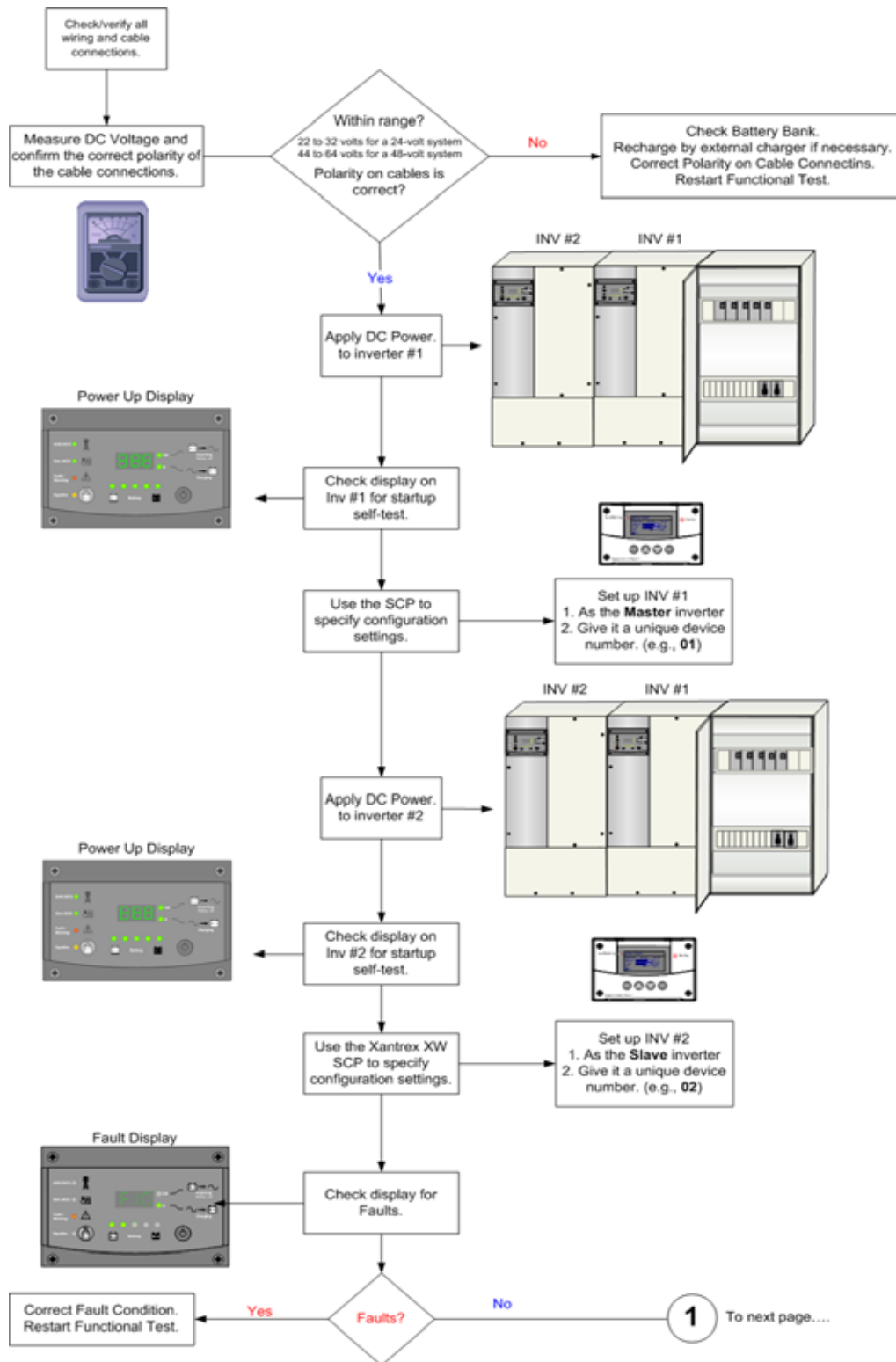

Figure 2-36 Functional Test for Multiple Inverters - Page 1 of 2

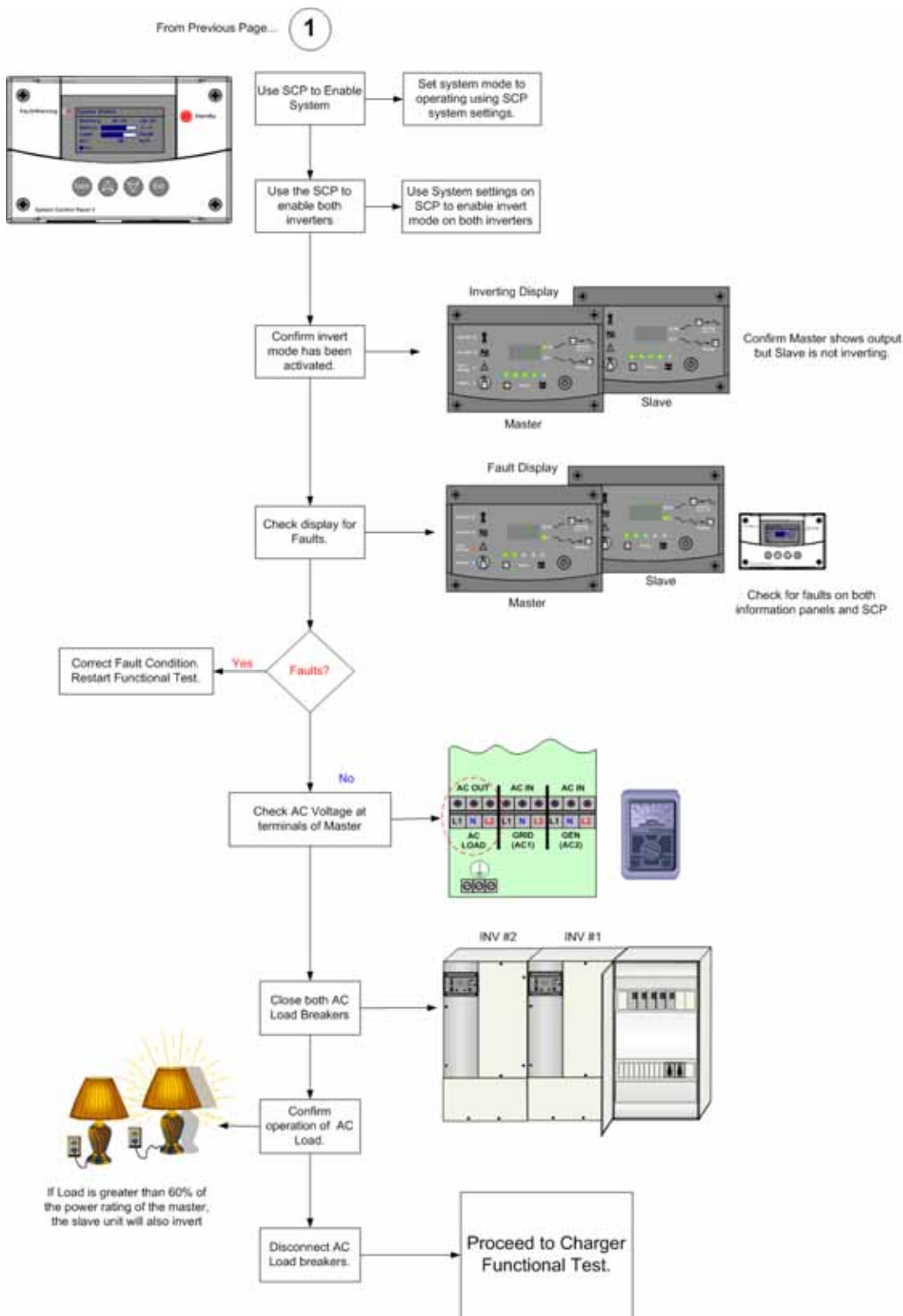

Figure 2-37 Functional Test for Multiple Inverters - Page 2 of 2

3

Xantrex Xanbus Network Installation

Chapter 3, "Xantrex Xanbus Network Installation" provides detailed information for planning and installing the components necessary for network communication on a Xantrex Xanbus system.

For this Topic	See....
"Xantrex Xanbus-Enabled Devices"	page 3-2
"The Xantrex Xanbus System"	page 3-2
"Installing the Network"	page 3-5

Xantrex Xanbus-Enabled Devices

The Xantrex Xanbus-enabled designation means that the product works on a Xantrex Xanbus network. Xantrex Xanbus-enabled products are:

- Easy to use. The Xantrex Xanbus network simplifies operation and automates routine tasks.
- Reliable. Software control eliminates errors due to analog signalling.
- Accurate. Digital information is less susceptible to interference and line loss.

The Xantrex Xanbus System

What is a network? A network is a collection of devices that perform individual functions, but also communicate and interact with the other devices. The network capability of the Xantrex XW Power System provides a robust, integrated product solution that simplifies and automates the installation, configuration, control, monitoring, and integration of devices that deliver and distribute AC or DC power.

Network components Each device is integrated into the network using cables, network connectors, and terminators. An example of a network-managed power system is shown in Figure 3-1.

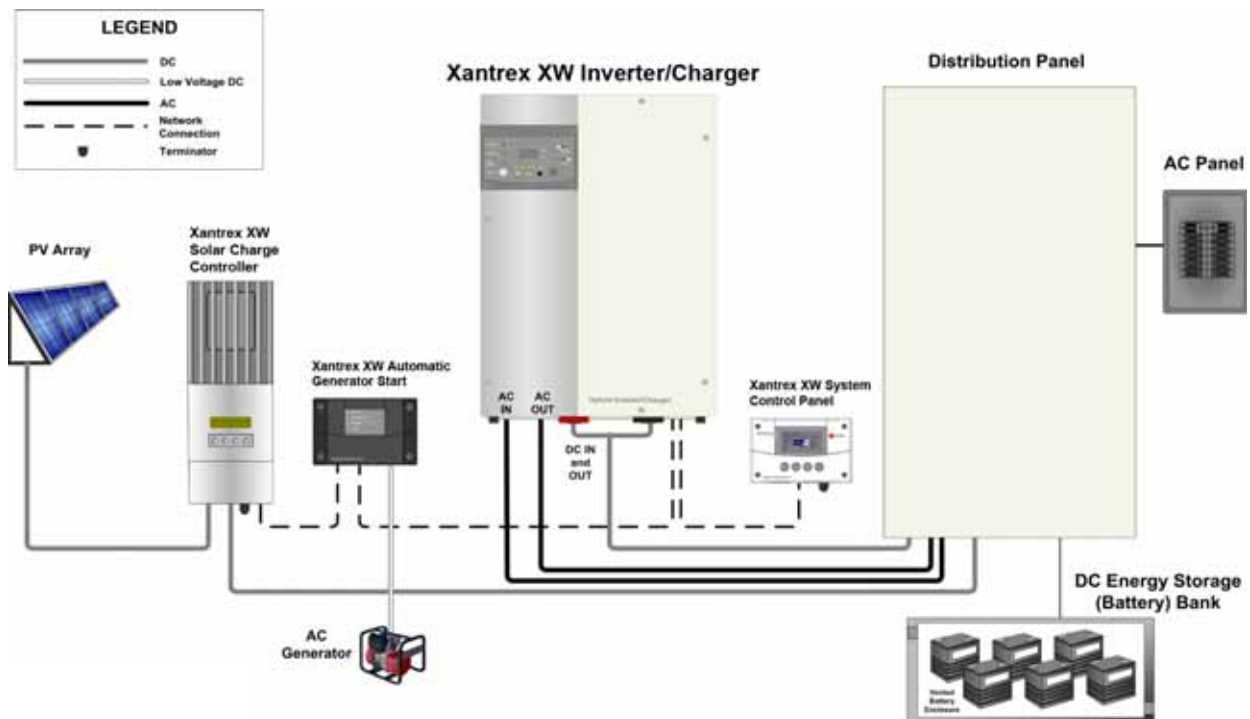

Figure 3-1 Network-Managed Power System

Network Components

A Xantrex Xanbus network consists of the following components:

- Xantrex Xanbus-enabled devices—these include the Xantrex XW System Control Panel, Xantrex XW Inverter/Charger, Xantrex XW Automatic Generator Start, and Xantrex XW Solar Charge Controller. The maximum number of Xantrex Xanbus devices connected to a single Xantrex Xanbus network should not exceed twelve.
- Xantrex Xanbus power supply—the network must have at least one device with a power supply to run the network. The total network current supplied by all the power-sourcing devices must be greater than or equal to the total current drawn by the power consuming devices. The power supply must be capable of providing 15 VDC/200 mA to each device. The Xantrex XW Inverter/Charger can provide sufficient network power.

For example, in a system with an inverter/charger, Xantrex XW System Control Panel, and Xantrex XW Automatic Generator Start, the inverter/charger is a power-sourcing device capable of providing 800 mA at 15 VDC while the two other devices each consume a maximum of 200 mA for a total maximum consumption of 400 mA. In this example, the network is properly configured from a power perspective because the power source is capable of providing more current than is needed: 800 mA > 400 mA.

Important: See the specifications for each Xantrex Xanbus device to determine how much power each device consumes or supplies.

- Xantrex Xanbus cables—each Xantrex Xanbus-enabled device is connected by a Category 5 (CAT 5 or CAT 5e) cable, a standard cable available from the manufacturer or any computer supply store. The cable consists of eight conductors in four twisted pairs with an RJ45 modular connector wired to the T568A standard.



CAUTION: Equipment Damage

Do not use crossover cable.

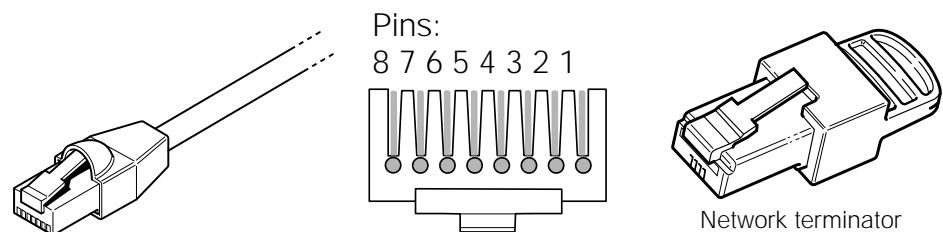

Figure 3-2 Xantrex Xanbus Cable, RJ45 Connector Pin Numbers and Network Terminators

- Network terminators — the Xantrex Xanbus network must be properly terminated at each end to ensure the communication signal quality on the network. If the network is not properly terminated, signal quality is degraded and performance on the network is reduced. Permanent configuration without terminators is not supported. The Xantrex XW Series Inverter/Charger and other Xantrex Xanbus-enabled devices ship with one terminator already installed. Depending on your network layout, this terminator may need to be removed and inserted into another device elsewhere in the network.

Ordering Network Components

Table 3-1 provides a partial list of network components and part numbers. Ready-made cables are available in standard lengths from 3 feet to 75 feet.

For the most up-to-date list, call an authorized dealer or visit the Outlet Store at www.schneider-electric.com.

Table 3-1 Xantrex Xanbus Network Components and Part Numbers

Network Component	Part Number
Network terminator	100-0224-01-01
Network cable 3 ft. (0.9 m)	809-0935
Network cable 25 feet (7.6 m)	809-0940
Network cable 75 feet (22.9 m)	809-0942

Network Layout

Each device on the network is linked with separate lengths of Xantrex Xanbus cable, as shown in Figure 3-3. This layout does not require network connectors. Two terminators are required to ensure the communication signal quality on the network. The Xantrex Xanbus-enabled devices at each end of the chain must have a male terminator inserted into their open network ports.

Advantage The advantage of this layout is that it is less expensive to install because network connectors are not required.

Disadvantage The disadvantage of the daisy chain layout is that Xantrex Xanbus-enabled devices cannot be removed from the network without interrupting the network. To make the network function after removing a device, you must connect the Xantrex Xanbus-enabled devices on either side of the missing device to each other or replace the device.

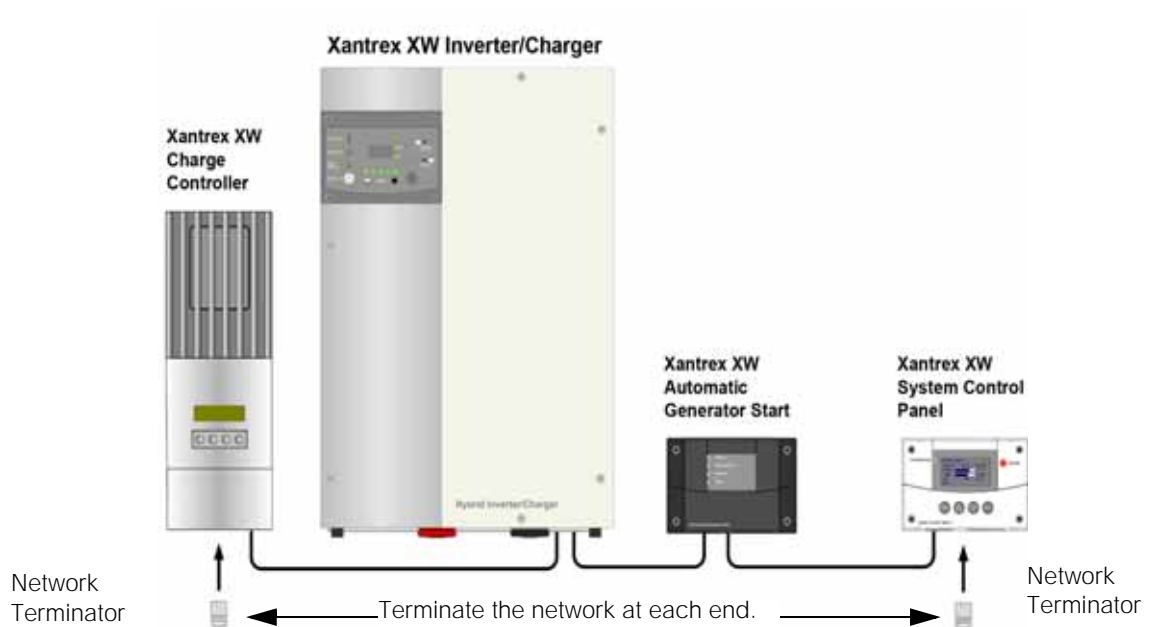

Figure 3-3 Network Layout

Installing the Network

Important: Installing and replacing Xantrex Xanbus-enabled devices in an existing system must be performed with the Xantrex XW Power System in standby mode. For more information about standby mode, see the *Xantrex XW System Control Panel Owner's Guide*.

Before You Begin the Installation

- Read the entire section before installing the network. It is important to plan the installation from beginning to end.
- Assemble all the tools and materials required for the installation.

Installation Tools and Materials

Tools

The following tools may be required to install the Xantrex Xanbus cables.

- Phillips screwdriver, appropriately sized
- Drill and 1/8" bit

Materials

The following materials may be required to complete the installation.

- CAT 5 or CAT 5e cables (available from the manufacturer or computer supply stores)
- Network connectors, if installing multi-drop backbone layout
- # 6 screws, 2 per each network connector installed
- Terminators

Guidelines for Routing the Xantrex Xanbus Cables



WARNING: Shock hazard

Do not route the Xantrex Xanbus cables in the same conduit or panel as the AC and DC power cabling.

To ensure maximum performance of your network, follow these guidelines when routing the Xantrex Xanbus cables.

- Route the cables away from sharp edges that might damage the insulation. Avoid sharp bends in the cable—no less than a 4-inch (100 mm) radius.
- Allow at least 2 ¼ inches (57 mm) of space behind the wall to accommodate the depth of the unit and allow room for the cables to bend.
- Allow for some slack in the cable tension.
- Keep the alignment of wire pairs inside the sheath as straight as possible.
- Allow separation between data and power cables (data cables should only cross a power cable at right angles).
- Do not staple the cable with metal cable staples. Use appropriate hardware fasteners to avoid damage to the cable.
- Support horizontal cables using J hooks or cable trays.

The total length of the network, including all connected Xantrex Xanbus-enabled devices and the Xantrex XW Series Inverter/Charger, cannot exceed 130 feet (40 m).

Installing Xantrex Xanbus-Enabled Devices

If you are installing a Xantrex Xanbus-enabled device on an existing Xantrex Xanbus system, put the system in standby mode using the `System Settings` menu on the Xantrex XW System Control Panel.



CAUTION: Equipment Damage

Only connect to other Xantrex Xanbus compatible devices. Although the cabling and connectors used in this network system are the same as ethernet connectors, **this network is not an ethernet system**. Equipment damage may result from attempting to connect Xantrex Xanbus to different systems.

Important: Mount cables and network connectors in a dry location.

To install the Xantrex Xanbus-enabled devices:

1. Determine and prepare the location for each device. Refer to the installation procedure for each device elsewhere in this manual.
2. Determine and measure the required cable length, taking into consideration your network layout, the routing, and strain relief requirements. Do not exceed the total recommended cable length of 130 feet (40 meters).
3. Mount the devices according to the installation procedure elsewhere in this guide.
4. Use an appropriate length of Xantrex Xanbus cable to connect each device and (if used) 3-way network connector.
5. Insert a terminator into the open network port of the Xantrex Xanbus-enabled device at each end of the network. See Figure 3-3.

**CAUTION: Unpredictable device behavior**

After connecting the Xantrex Xanbus-enabled devices and terminating the network, do not plug terminators or other cables into any remaining open network ports on any Xantrex Xanbus-enabled devices.

Do not connect one end of the network to the other to make a ring.

4

Xantrex XW Solar Charge Controller Installation

Chapter 4, "Xantrex XW Solar Charge Controller Installation" describes how to mount and connect the Xantrex XW Solar Charge Controller as part of the Xantrex XW System.

For this Topic	See....
"PV Array Requirements"	page 4-2
"Mounting"	page 4-3
"Grounding"	page 4-9
"Wiring"	page 4-12
"Commissioning"	page 4-19

Installing the Xantrex XW Solar Charge Controller

This chapter describes installing the Xantrex XW Solar Charge Controller (Xantrex XW SCC) with the Xantrex XW Power System, including the power distribution panel. For stand-alone installation, see the *Xantrex XW Solar Charge Controller Owner's Guide*.

PV Array Requirements

Note: The following information provides general guidelines only. The installation and rated performance of your PV array is subject to inspection and approval by the authority having jurisdiction.

Each Xantrex XW SCC must be connected to its own PV array. Although the Xantrex XW SCC can harvest a maximum of 3500 W, the PV array size can be as high as 6720 W (based on 48 A × 140 VOC = 6720 W).



CAUTION: Equipment damage

The PV array voltage must never exceed 150 VOC (open circuit voltage) under any conditions. The array I_{sc} (short circuit current) must not exceed the 60 A input current rating of the Xantrex XW SCC at any time.

Panels rated up to 48 A at 77 °F (25 °C) are recommended to allow for increases in I_{sc} caused by irradiance enhancement under certain conditions (reflection from snow, for example).

MPPT Voltage Range

The Xantrex XW SCC maximum power point tracking algorithm maximizes the output energy of PV arrays as long as the operating voltage is within the MPPT operational window. Ensure that the PV array used in the system operates within the MPPT operational window. Effects of array voltages outside of the MPPT operational window are shown in Table 4-1.

Table 4-1 MPPT Operational Window

Voltage	Effect of Array Voltage	Xantrex XW Series Inverter/Charger Mode
VOC < VBATT (system battery voltage)	Xantrex XW SCC not operating.	Low Light
VMPP < VBATT	Harvest of solar energy less than optimal.	Charging
VMPP = VBATT to 120 VDC	Maximum harvest of solar energy.	Charging (MPPT window)

Table 4-1 MPPT Operational Window

Voltage	Effect of Array Voltage	Xantrex XW Series Inverter/Charger Mode
120 VDC < VMPP < 140 VDC	Xantrex XW SCC reduces the output current limit to protect the unit from voltage spikes.	Input voltage derating
VMPP > 140 VDC (or VOC > 140 VDC)	Xantrex XW SCC shuts down. Unit may be damaged if VOC > 150 V.	Over-voltage fault

Mounting

The instructions in this section apply to an installation including the power distribution panel. Installation procedures will vary according to your specific application. For special applications, consult a qualified electrician or your Schneider Electric Certified Dealer.

Important: Installations must be compliant with all local electrical codes.

Installation of this equipment should only be performed by a qualified electrician or by a Certified Renewable Energy (RE) System installer.

Choosing a Location

The Xantrex XW Solar Charge Controller is designed to be mounted vertically to the side or the top of the power distribution panel. The Xantrex XW SCC must be installed indoors in a dry, protected location away from flammable materials, sources of high temperature, moisture, vibration, and direct sunlight. The location must also be sheltered from direct sunlight, rain, snow, and wind-blown debris.



CAUTION: Equipment Damage

Never install the Xantrex XW SCC where it is exposed to salt water spray. Exposure to salt water will void the warranty and may cause a malfunction or a shock hazard.



WARNING: Explosion/Corrosion Hazard

To reduce the risk of fire or explosion, do not install the Xantrex XW SCC in sealed compartments containing batteries or in locations that require ignition-protected equipment.

To reduce the risk of corrosion from hydrogen-sulfide gas vented by batteries, do not install the Xantrex XW SCC in sealed compartments containing batteries.

If using sealed batteries, the controller can be mounted in the same enclosure as long as it is adequately ventilated.

For optimal and safe operation, ensure there is adequate clearance around the Xantrex XW SCC. See Table 4-2. If clearances are reduced below these minimums, rated performance may not be achieved.

Table 4-2 Minimum Clearance Requirements

Location	Minimum Clearance
Above	6 inches (150 mm). When units are mounted to the side of the power distribution panel in a vertical stack, the top unit must maintain the minimum clearance to the nearest surface.
In front	Sufficient room to allow for easy access to read the display, to prevent accidental contact with the heat sink, and to perform maintenance.
On sides	6 inches (150 mm) on at least one side of the overall assembly. A maximum of two units can be mounted side by side or side mounted against the power distribution panel. In both configurations, the minimum clearance around the outer unit must be maintained.

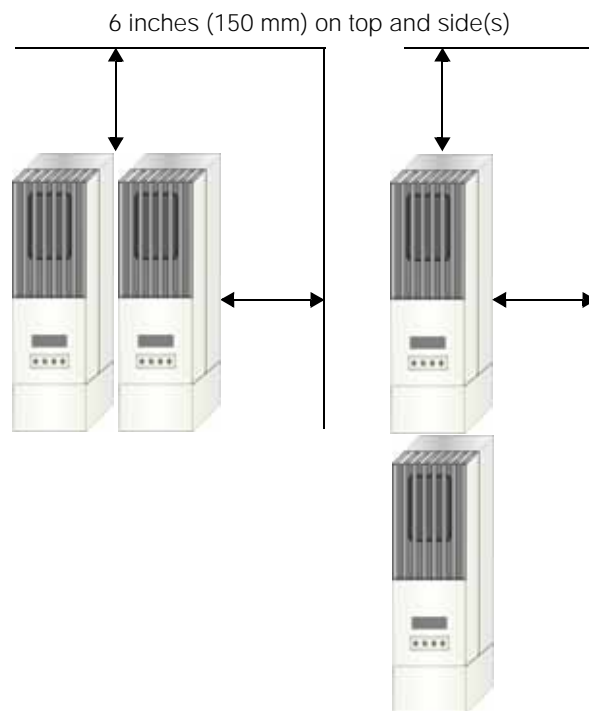

Figure 4-1 Minimum Clearance Requirements

Removing the Wiring Compartment Cover

Before mounting, you must remove the wiring compartment cover to access the mounting holes and the wiring terminals. The wiring compartment cover is secured with two Phillips #8-32 × 2 ½-inch (63.5 mm) screws on the front cover of the unit. See Figure 4-2.

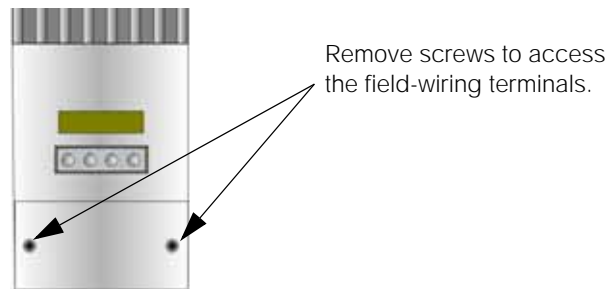

Figure 4-2 Removing the Wiring Compartment Cover

Removing Knockouts

Six dual and two single knockouts are provided for routing battery, PV array, BTS, and network cables into the Xantrex XW SCC. Bushings or conduits must be used to protect the wiring from damage from rough edges around the knockout holes. When removing knockouts, make sure no metal shavings or fragments fall into the wiring compartment.

Important: Do not drill, cut, or punch holes in the Xantrex XW SCC. Use only the knockouts provided for conduit entry.

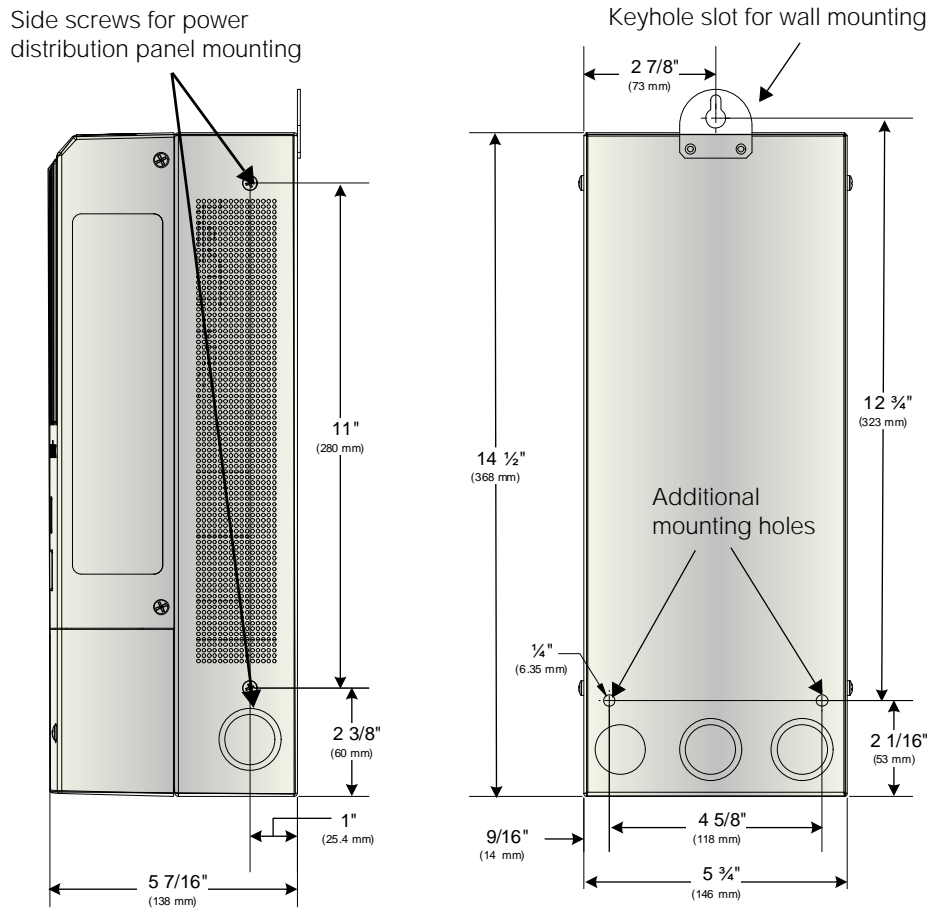

Figure 4-3 Dimensions and Knockout Locations

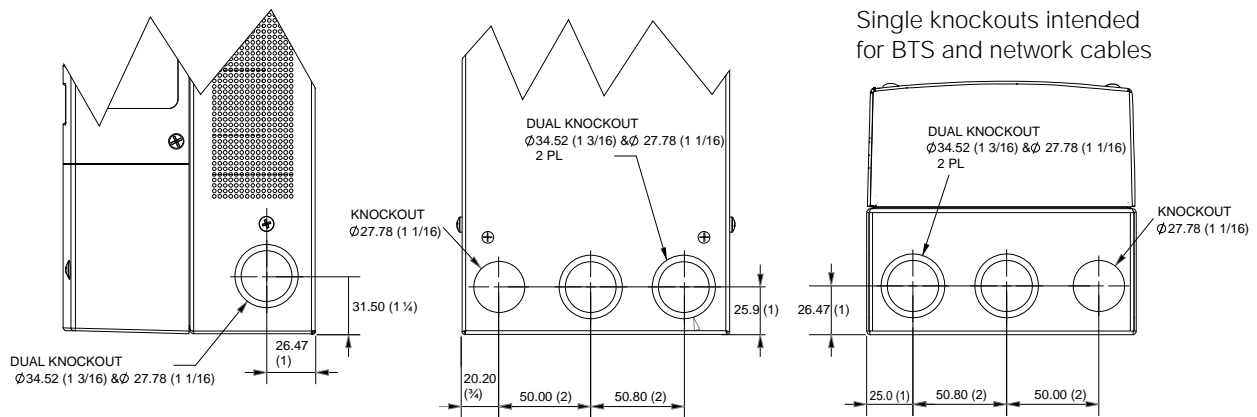

Figure 4-4 Knockout Dimensions

Mounting the Xantrex XW Solar Charge Controller

The Xantrex XW SCC can be mounted to either the side or the top of the power distribution panel. The power distribution panel has keyhole slots and screw holes for side mounting and two pairs of conduit holes for top mounting the Xantrex XW SCC.

To mount the Xantrex XW SCC to the side of the power distribution panel:

1. Back out the top side screw on the Xantrex XW SCC by ¼-inch (6 mm).
2. Remove the lower side screw on the Xantrex XW SCC.
3. Holding the unit against the side of the power distribution panel, insert the top side screw into one of the two keyhole slots on the side of the power distribution panel, and pull the unit down into the slot.
4. Insert the lower side screw through the hole on the inside of the power distribution panel and into the side of the Xantrex XW SCC.
5. Tighten the lower side screw to secure the Xantrex XW SCC.

To mount the Xantrex XW SCC to the top of the power distribution panel:

1. Remove a pair of knockouts from the top of the power distribution panel.
2. Remove the bottom knockouts from the Xantrex XW SCC.
3. Align the knockouts on the power distribution panel and Xantrex XW SCC, and secure the unit with two locking strain reliefs or threaded connectors.

In a stand-alone installation, the Xantrex XW SCC is mounted using three #10 × ½-inch or #12 × ½-inch (12.5 mm) pan-head screws.

To mount the Xantrex XW SCC away from the power distribution panel:

1. Remove the wiring terminals cover.
2. Mark the location of the keyhole slot on the wall.
3. Secure the top mounting screw in the location marked. Leave the screw head backed out approximately ¼ inch (6 mm).
4. Place the Xantrex XW SCC onto the screw and pull it down into the keyhole slot.
5. Insert two screws in the two mounting holes provided to secure the unit to the wall.
6. Provide strain-relief clamps or conduit to prevent damage to the circuit board and to prevent the terminal block from pulling on the wires.

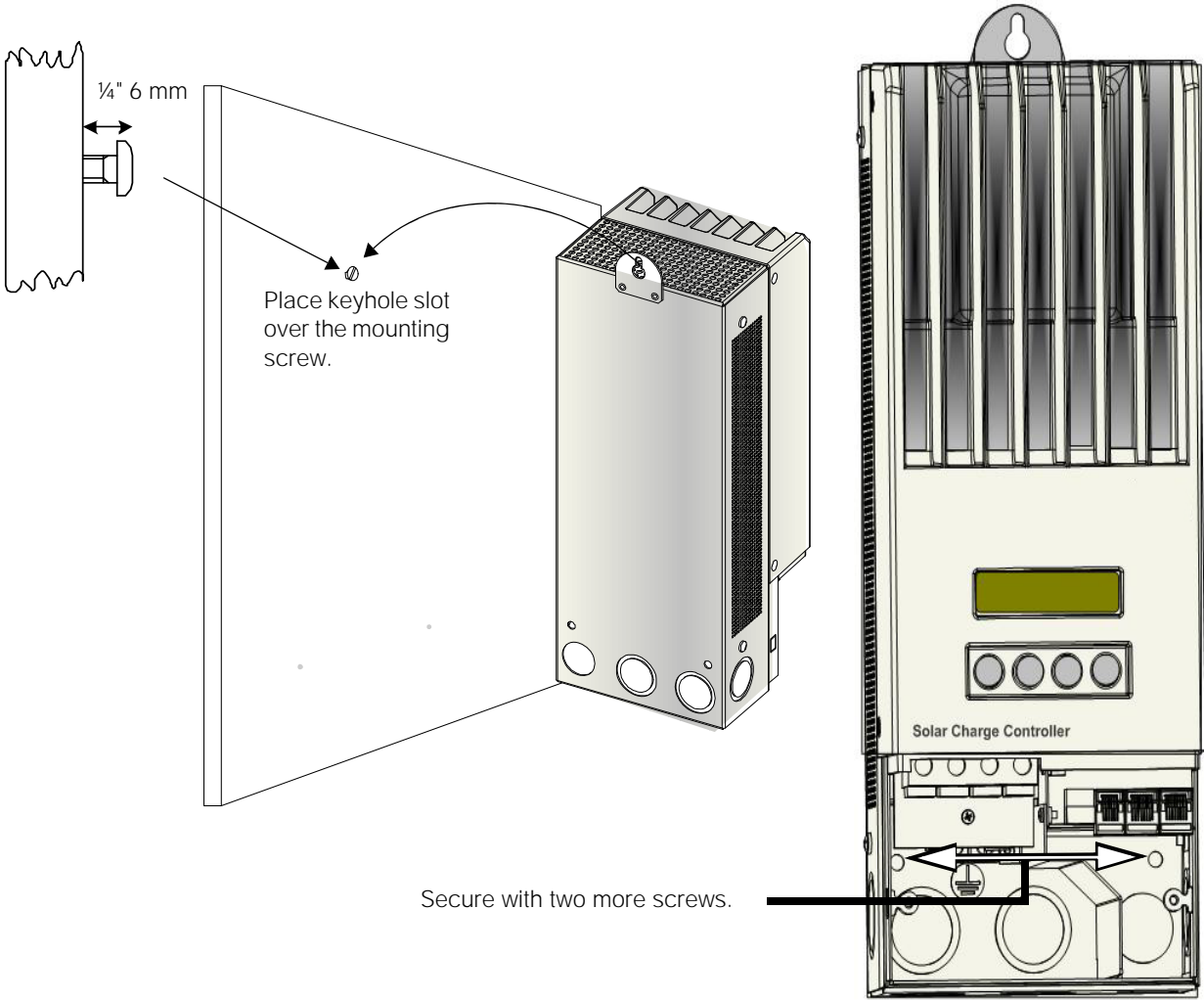

Figure 4-5 Mounting the Xantrex XW Solar Charge Controller

Grounding

The Xantrex XW SCC can be configured to be compatible with either negative-grounded or ungrounded PV systems. The maximum size of the ground conductor is #6 AWG (16 mm²). This wire gauge is determined by electrical code requirements regarding conduit knockout sizes, wire bending radius, and space available within the Xantrex XW Series Inverter/Charger wiring compartment. For ground conductor requirements for your specific installation, consult your local electrical code.

Internal Ground Fault Protection

The Xantrex XW SCC has a PV ground fault protection (Xantrex PV GFP) fuse (600 V, 1 A) and a PV negative-ground jumper located inside the wiring compartment. These provide a negative ground bond and ground-fault protection for negative grounded PV array systems common in North American installations. Replace the fuse with Littelfuse KLKD 1 or equivalent.



WARNING: Fire hazard

- Fuses must only be replaced by qualified service personnel, such as a certified electrician or technician. For continued protection against risk of fire, replace only with the same type and rating of fuse.
- If Xantrex PV GFP is enabled, do not ground either PV negative or battery negative circuits. Grounding these circuits will defeat the internal Xantrex PV GFP protective function.



WARNING: Shock hazard

Disconnect PV and battery circuits before removing the grounding connections or before removing or installing the Xantrex PV GFP fuse. Wait at least four minutes for the internal circuitry to discharge before servicing the unit.

Important: Only one Xantrex XW SCC is to have the Xantrex PV GFP fuse installed in installations with multiple parallel units. Before mounting and connecting the Xantrex XW Solar Charge Controllers, remove the Xantrex PV GFP fuse from each unit except one.



CAUTION

The factory default configuration of the Xantrex XW SCC will ground the PV array negative to the chassis ground through the internal Xantrex PV GFP fuse. The Xantrex PV GFP circuit must be disabled for ungrounded PV arrays.

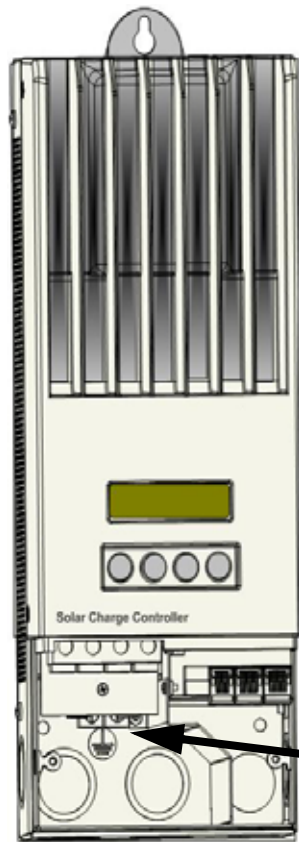

WARNING: Fire Hazard

Make sure there is no other ground connection in the DC wiring or the Xantrex PV GFP will be defeated and will not protect the array from ground fault conditions.



This symbol identifies the protective conductor (grounding) connection.

Chassis ground terminals.
The Xantrex PV GFP fuse is located under the power connector circuit board

Figure 4-6 Xantrex XW Solar Charge Controller Safety Ground Connector



WARNING: Shock Hazard

Disconnect PV and battery circuits before removing the grounding connection or before removing or installing the Xantrex PV GFP fuse.

Disabling Ground Fault Protection for Negative Grounded and Ungrounded Arrays

To install the Xantrex XW SCC in a system where an external negative-ground bond is required or where the PV array must not be grounded, the Xantrex XW SCC internal Xantrex PV GFP circuit and ground bond must be disabled. To disable the unit's Xantrex PV GFP circuit and ground bond, move the jumper connector located on the circuit board within the wiring compartment. See Figure 4-7.



WARNING: Shock Hazard

Disconnect PV and battery circuits before accessing the Xantrex XW SCC wiring compartment.

Disabling the Xantrex PV GFP circuit in this way opens the negative-to-ground bond within the unit. This provides the option of using an external PV GFP circuit, operating the Xantrex XW SCC with an ungrounded PV array, or grounding the negative circuit of the battery elsewhere in the system.

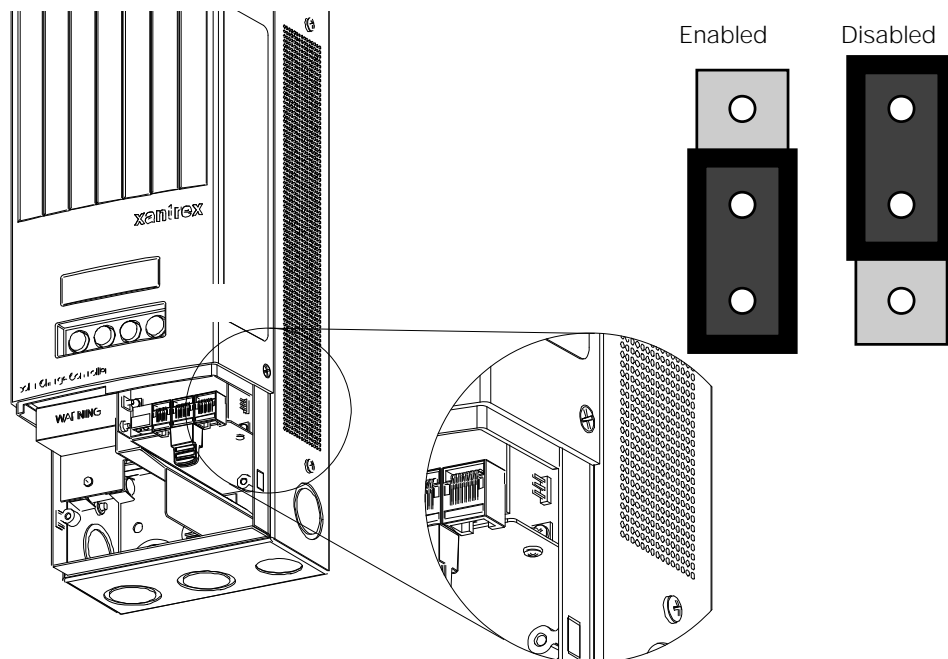

Figure 4-7 PV Negative Ground Jumper Location

Wiring

Important: Installations must meet all local electrical codes. Installations of this equipment should only be performed by a qualified electrician or a Certified Renewable Energy (RE) System Installer.



WARNING: Shock Hazard

Disconnect battery and PV sources before wiring.

DC Terminal Connector Locations

Terminal connectors for DC wiring are located inside the wiring compartment. The labels above the DC wiring terminals and inside the wiring compartment identify all the connection points. See Figure 4-8.

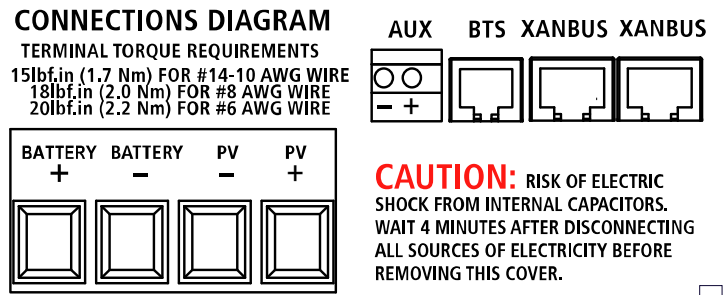

Figure 4-8 DC Connection Terminals

Wire Size and Overcurrent Protection Requirements

The wiring, overcurrent protection devices (fuses and circuit breakers), and installation methods used must conform to all national and local electrical code requirements. Wiring must be protected from physical damage with conduit or a strain relief clamp.

To preserve signal integrity on communication cables, the BTS, auxiliary output, and network cables must pass through a different conduit than the conduits used for PV and battery cables. You should pull the BTS cable through the conduit first as the connector may not fit if other wires have been pulled first.

Current Rating

The Xantrex XW SCC PV input is rated for 60 A maximum I_{SC} . Since PV outputs can vary due to the array size or sunlight angle, the safe minimum wire size must be chosen for maximum array short-circuit current. Consult PV array manufacturer specifications.

Minimum Wire Gauge

For installations where the PV array output is the maximum allowable 60 A I_{SC} , the minimum allowable wire gauge is #6 AWG (16 mm²) copper wire with a 90 °C (194 °F) insulation rating. This wire gauge is determined by electrical code requirements regarding conduit knockout sizes, wire bending radius, and space available within the Xantrex XW SCC wiring compartment. No crimp-on terminals or lugs are required.

Overcurrent Protection

Overcurrent protection must be installed to protect the Xantrex XW SCC from short circuits and to provide a means of disconnecting the Xantrex XW SCC. Consult local electrical codes to establish the correct fuse or circuit breaker rating.

Battery Circuit The NEC requires the battery circuit to be protected with a device rated for 125% of the rating of the circuit. The DC-rated fuse or circuit breaker between the battery and the Xantrex XW SCC must be rated for 1.25×60 A (the maximum current rating of the Xantrex XW SCC).

PV Circuit A PV disconnect device between the PV array and the Xantrex XW SCC must be rated for 60 A.

Long-Distance Wire Runs

If there is a significant distance between the PV array and the Xantrex XW SCC or between the Xantrex XW SCC and the battery, larger wires can be used to reduce the voltage drop and improve performance. Refer to Table 4-4 or Table 4-5.



WARNING: Equipment damage

Do not connect an array capable of delivering over 60 A I_{SC} to the Xantrex XW SCC. Wire sizes larger than #6 AWG (16 mm²) may be used to reduce resistive losses but should not be installed directly into the Xantrex XW SCC. Use a splicer block or similar to connect wires of different gauges together. Follow manufacturer's recommendations for torque and mounting.

Table 4-3 Recommended Circuit Breakers for the Xantrex XW Solar Charge Controller

Part Number	Description
865-1065	Qty 6, Breaker 250A, 160 VDC, Stud Terminal, Panel Mount, UL/CSA
865-1070	Qty 12, Breaker 80A, 125 VDC, Panel Mount, UL/CSA
865-1075	Qty 48, Breaker 60A, 160 VDC, Panel Mount, UL/CSA

Important: Local and national electrical codes must be followed for determining additional installation requirements.

Larger wire sizes may be used to improve performance, but may not be installed directly into this Charge Controller. Use a splicer block as previously described.

Maximum One-way Distance and Wire Size

Refer to Table 4-4 or Table 4-5 and find the maximum current in the left column and the one-way distance from the PV array to the Xantrex XW SCC (or the distance from the Xantrex XW SCC to the battery) on the same line, then read the wire size required at the top of the column. For equivalent metric wire sizes, consult a local electrician or certified installer.

Table 4-4 One-Way Wire Distance and Wire Size for a 24 VDC System

**Maximum one-way wire distance for a < 3% voltage drop assuming 60 ADC charging current
For 24 VDC systems**

Distance in feet (meters)					Distance in feet (meters) ^a				
Amps	12 AWG	10 AWG	8 AWG	6 AWG	4 AWG	3 AWG	2 AWG	1 AWG	1/0 AWG
10	17.6 (5.36)	28.0 (8.54)	44.4 (13.54)	70.6 (21.52)	112.2 (34.2)	141.8 (43.22)	179.2 (54.62)	225.0 (68.58)	283.4 (86.38)
12	14.6 (4.46)	23.2 (7.08)	37.0 (11.28)	58.8 (17.92)	93.4 (28.46)	118.2 (36.02)	149.2 (45.48)	187.4 (57.12)	236.2 (72.00)
14	12.6 (3.84)	20.0 (6.10)	31.8 (9.70)	50.4 (15.36)	80.2 (24.44)	101.2 (30.84)	128.0 (39.02)	160.8 (49.02)	202.4 (61.70)
16	11.0 (3.36)	17.4 (5.30)	27.8 (8.48)	44.2 (13.48)	70.0 (21.34)	88.6 (27.0)	112.0 (34.14)	140.6 (42.86)	177.2 (54.02)
18	9.8 (2.98)	17.6 (4.76)	24.8 (7.56)	39.2 (11.94)	62.4 (19.02)	78.8 (24.02)	99.6 (30.36)	125.0 (38.10)	157.4 (47.98)
20	8.8 (2.68)	14.0 (4.26)	22.2 (6.76)	35.2 (10.72)	56.0 (17.06)	70.8 (21.58)	89.6 (27.32)	112.4 (34.26)	141.8 (43.20)
25		11.2 (3.42)	17.8 (5.42)	28.2 (8.60)	44.8 (13.66)	56.6 (17.26)	71.6 (21.82)	90.0 (27.44)	113.4 (34.56)
30		9.4 (2.86)	14.8 (4.52)	23.6 (7.20)	37.4 (11.4)	47.2 (14.38)	59.8 (18.22)	75.0 (22.86)	94.4 (28.78)
35			12.8 (3.90)	20.2 (6.16)	32.0 (9.76)	40.4 (12.32)	51.2 (15.6)	64.2 (19.56)	81.0 (24.68)
40			11.2 (3.42)	17.6 (5.36)	28.0 (8.54)	35.4 (10.78)	44.8 (13.66)	56.2 (17.12)	70.8 (21.58)
45				15.6 (4.76)	25.0 (7.62)	31.4 (9.58)	39.8 (12.14)	50.0 (15.24)	63.0 (19.20)
50				14.2 (4.32)	22.4 (6.82)	28.4 (8.66)	35.8 (10.92)	45.0 (13.72)	56.6 (17.26)
60				12.6 (3.84)	18.6 (5.66)	23.6 (7.20)	29.8 (9.08)	37.4 (11.4)	47.2 (14.38)

a. These wire sizes are not approved by UL to be installed in the controller, but may be used external to the controller (using a splicer block) to reduce voltage drop and improve performance.

Table 4-5 One-Way Wire Distance and Wire Size for a 48 VDC System

**Maximum one-way wire distance for a < 3% voltage drop assuming 60 ADC charging current
For 48 VDC systems**

Distance in feet (meters)					Distance in feet (meters) ^a				
Amps	12 AWG	10 AWG	8 AWG	6 AWG	4 AWG	3 AWG	2 AWG	1 AWG	1/0 AWG
10	70.4 (21.44)	112.0 (34.16)	177.6 (54.16)	282.4 (86.80)	448.8 (136.8)	567.2 (172.88)	716.8 (218.48)	900.0 (274.32)	1133.6 (345.52)
12	58.4 (17.84)	92.8 (28.32)	148.0 (45.12)	235.2 (71.68)	373.6 (113.84)	472.8 (144.08)	596.8 (181.92)	749.6 (228.48)	944.8 (288.00)
14	50.4 (15.36)	80.0 (24.40)	127.2 (38.8)	201.6 (61.44)	320.8 (97.76)	404.8 (123.36)	512.0 (156.08)	643.2 (196.08)	809.6 (246.80)
16	44.0 (13.44)	69.6 (21.20)	111.2 (33.92)	176.8 (53.92)	280.0 (85.36)	354.4 (108.00)	448.0 (136.56)	562.4 (171.44)	708.8 (216.08)
18	39.2 (11.92)	70.4 (19.04)	99.2 (30.24)	156.8 (47.76)	249.6 (76.08)	315.2 (96.08)	398.4 (121.44)	500.0 (152.40)	629.6 (191.92)
20	35.2 (10.72)	56.0 (17.04)	88.8 (27.04)	140.8 (42.88)	224.0 (68.24)	283.2 (86.32)	358.4 (109.28)	449.6 (137.04)	567.2 (172.80)
25		44.8 (13.68)	71.2 (21.68)	112.8 (34.40)	179.2 (54.64)	226.4 (69.04)	286.4 (87.28)	360.0 (109.76)	453.6 (138.24)
30		37.6 (11.44)	59.2 (18.08)	94.4 (28.80)	149.6 (45.60)	188.8 (57.52)	239.2 (72.88)	300.0 (91.44)	377.6 (115.12)
35			51.2 (15.60)	80.8 (26.64)	128.0 (39.04)	161.6 (49.28)	204.8 (62.40)	256.8 (78.24)	324.0 (98.72)
40			44.8 (13.68)	70.4 (21.44)	112.0 (34.16)	141.6 (43.12)	179.2 (54.64)	224.8 (68.48)	283.2 (86.32)
45				62.4 (19.04)	100.0 (30.48)	125.6 (38.32)	159.2 (48.56)	200.0 (60.96)	252.0 (76.80)
50				56.8 (17.28)	89.6 (27.28)	113.6 (34.64)	143.2 (43.68)	180.0 (54.88)	226.4 (69.04)
60				50.4 (15.36)	74.4 (22.64)	94.4 (28.80)	119.2 (36.32)	149.6 (45.60)	188.8 (57.52)

a. These wire sizes are not approved by UL to be installed in the controller, but may be used external to the controller (using a splicer block) to reduce voltage drop and improve performance.

Connecting the Xantrex XW Solar Charge Controller to the Distribution Panel



WARNING: Shock Hazard

Whenever a PV array is exposed to light, a shock hazard exists at the output wires or exposed terminals. To reduce the risk of shock during installation, cover the array with an opaque (dark) material before making the connections.



WARNING: Shock Hazard

Do not connect the battery negative to ground. Bonding the battery negative to ground disables PV ground-fault protection. For more information, see "Grounding" on page 4-9. See Figure 4-9 on page 4-18 for correct routing of the battery negative.



CAUTION: Equipment damage

Do not connect the PV negative and battery negative terminals together anywhere in the system, including the Xantrex XW Power Distribution Panel or other DC disconnect. The PV negative and battery negative must be connected to separate terminals as marked on the unit.

To connect the Xantrex XW Solar Charge Controller:

1. Make sure the PV array disconnect and battery disconnect are turned off.
 2. Ground the Xantrex XW SCC. Connect a grounding conductor between a Xantrex XW SCC ground lug and the power distribution panel ground bus. See Figure 4-9.
 3. Connect the PV array negative (-) output to the Xantrex XW SCC terminal marked PV -.
 4. Connect the PV array's positive (+) output to the PV array disconnect.
 5. Route another positive (+) cable from the other end of the PV disconnect to the Xantrex XW SCC terminal marked PV +.
 6. Connect the negative (-) battery cable to the Xantrex XW SCC terminal marked BAT -.
 7. Connect a positive (+) cable from the Xantrex XW SCC terminal marked BAT + to the battery disconnect.
-



CAUTION: Reverse polarity damage

Before making the final DC connection or closing the DC breaker or disconnect, check cable polarity at both the battery and the Xantrex XW SCC. Positive (+) must be connected to positive (+). Negative (-) must be connected to negative (-).

8. Connect a second positive (+) cable to the other side of the battery disconnect and connect to the positive (+) battery terminal.
9. Torque the Xantrex XW SCC terminals according to the following table:

Wire Size		Torque Value	
AWG	mm ²	in-lb	Nm
14-10	2.5-6	15	1.7
8	10	18	2.0
6	16	20	2.25

Be careful not to overtighten. Allow some slack on the cables within the controller and secure the wiring with strain reliefs or cable clamps.

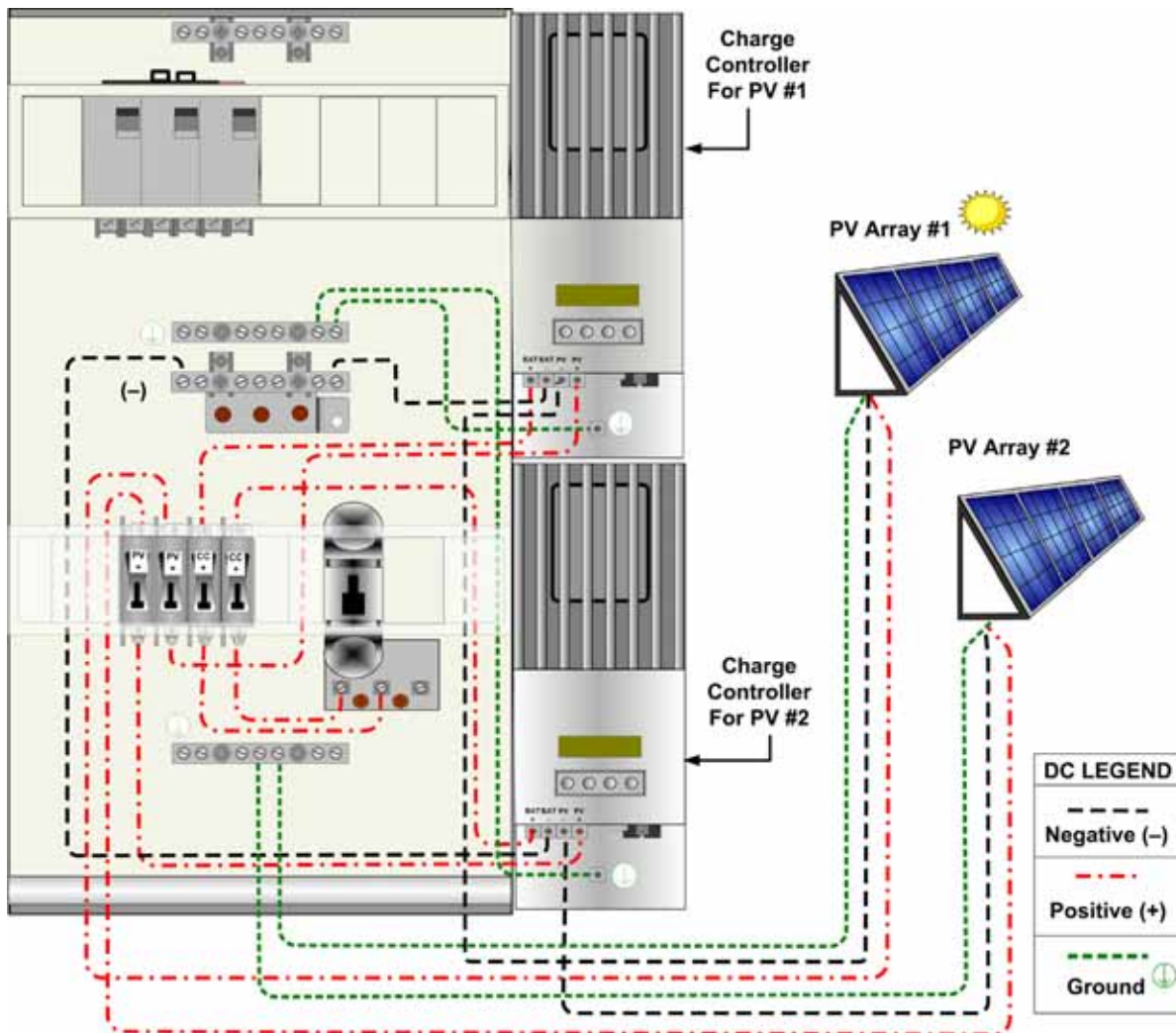

Actual wiring requirements may vary

Figure 4-9 Connecting Solar DC Sources in the Power Distribution Panel

Commissioning

During commissioning, the Xantrex XW Solar Charge Controller prompts the installer to enter important system information such as the nominal battery voltage, battery type, and battery bank capacity. Make sure the system information is available prior to commissioning.

If a Xantrex XW System Control Panel (Xantrex XW SCP) is present, it is intended to be the configuration interface, so the prompt screens are suppressed. If you prefer to configure using the prompt screens, disconnect the Xantrex Xanbus cable connecting the Xantrex XW SCP from the Xantrex XW SCC before powering up for the first time.



WARNING

Make sure the battery type and battery voltage are selected correctly on the Xantrex XW System Control Panel. Failure to select the correct battery type and voltage may overheat and damage the battery.

Configuration Screens

When power is first applied to the Xantrex XW SCC, several configuration screens prompt you to enter the following information:

- A DC out (battery) connection, which enables the Xantrex XW SCC to read and share the same battery information with other Xantrex Xanbus-enabled devices that charge or invert from the same battery bank.
- Battery type: Flooded (default), Gel, AGM, or Custom.

If you select Custom, the settings for battery type match the default settings for flooded batteries until you reconfigure the settings on the Custom Battery menu.

- Nominal battery voltage of the battery bank connected to the Xantrex XW SCC.

The Xantrex XW Solar Charge Controller automatically detects battery voltages of 12 V, 24 V and 48 V.

- Battery bank capacity, in amp hours.

Commissioning Units Using a Xantrex XW System Control Panel

In systems where a Xantrex XW SCP is present, it is intended to be the configuration interface. For information about Xantrex XW SCP navigation and menus, see Appendix B, "Xantrex XW System Control Panel Menus" in the *Xantrex XW Solar Charge Controller Owner's Guide*.

Commissioning units using a Xantrex XW SCP involves three separate procedures:

1. Setting the device numbers for all Xantrex XW SCCs.
2. Configuring connections and charger settings for the first Xantrex XW SCC.
3. Copying settings from the first unit to the other Xantrex XW SCC.

To set the device numbers for all Xantrex XW Solar Charge Controllers:

1. Make sure power is applied to the Xantrex XW SCP.
2. Close the DC disconnect or use a selector switch to apply battery power to all of the Xantrex XW SCCs at the same time. When the Xantrex XW SCCs are powered up, they will detect that a Xantrex XW SCP is already operating on the network and be ready for configuration through the Xantrex XW SCP. Do not apply PV power at this point.
3. From the **Select Device** menu on the Xantrex XW SCP, select a Xantrex XW Solar Charge Controller (each unit should appear as **MPPT60 00** where the 60 stands for 60 A, and the 00 is its device number).
4. On the **MPPT Setup** menu, make sure the **Advanced Settings** item is displayed. If **Advanced Settings** is not displayed (and **Basic Settings** appears as the last item on the menu), press the up arrow, down arrow and Exit keys together. (For more information about advanced settings, see Appendix B in the *Xantrex XW Solar Charge Controller Owner's Guide*.)
5. Select **Advanced Settings**, then select the **Multi Unit Config** menu. After entering the **Multi Unit Config** menu, the LCD backlight on the Xantrex XW Solar Charge Controller to be configured will flash.
6. On the **Multi Unit Config** menu, select **Dev Number** and set it to a number other than 00. Press Enter to confirm the new device number.

The device number can be set to any number between 01 and 31. For the first Xantrex XW Solar Charge Controller, 01 is recommended. If you have two charge controllers, set them to 01 and 02.
7. Press Exit until the **Select Device** menu is displayed.

The Xantrex XW Solar Charge Controller now appears as **MPPT60 01** on the menu.
8. Repeat steps 3 through 7 for the next Xantrex XW Solar Charge Controller.

When you have set the device number for all Xantrex XW Solar Charge Controllers, you can configure connection and charger settings for the first Xantrex XW Solar Charge Controller.

To configure connection and charger settings for the first Xantrex XW Solar Charge Controller:

1. On the `Select Device` Menu, select `MPPT60 01`.
2. Navigate to the `Multi Unit Config` menu and select `Connections`.
On the `Connections` menu, you can configure `PV In` (PV input) and `DC Conn` (DC output, or the battery bank). If the system has only one battery bank, leave `DC Conn` at the default setting. The `PV In` setting allows you to differentiate which array is going to which Xantrex XW Solar Charge Controller. This setting is used for status reporting only, not for any internal controls. Setting `PV In` to a non-default value is optional.
3. Press `Exit` twice to leave the `Connections` menu and `Multi Unit Config` menu.
4. From the `Advanced Settings` menu, select `Charger Settings`.
5. Set the `Battery Type`, `Battery Capacity`, and any other charger settings required for your system.

While in the `Charger` menu, make sure that the nominal battery voltage is set correctly (it is shown as `Batt Voltage` and appears as the last item on the menu). If you select `Custom` for your battery type, you can further configure the bulk, absorption, float and other settings for the charge cycle. The first Xantrex XW SCC should now be configured properly for your system.

If multiple Xantrex XW SCCs are installed, you can now copy the first unit's configuration over to other units.

To copy the Xantrex XW Solar Charge Controller setup to another unit:

1. On the SCP, press `Exit` to leave the `Advanced Settings` menu and view the `Select Device` menu.
2. On the `Select Device` menu, select the next Xantrex XW SCC for configuration.
3. On the `Advanced Settings` menu, select `Copy from?`, and then select the Xantrex XW Solar Charge Controller you want to copy from. You should select the unit with the device number that matches the first unit you configured.
4. Press `Enter`.

The settings are automatically copied from the selected unit.

Note: The copy from command will not give you any indication that it has completed its task. However, you can quickly check for yourself that the charger settings you have chosen have been copied properly by viewing some of the settings you originally configured.

5. Uncover the PV array and/or apply power with the disconnect or selector switch.

The Xantrex XW SCC starts up in sleep mode and waits for a short period to determine that the input voltage is greater than the output voltage. After the input voltage exceeds the output voltage by the required margin for 10 seconds, the unit begins operating.

5

Xantrex XW System Accessories Installation

Chapter 5, "Xantrex XW System Accessories Installation" describes how to mount and install the Xantrex XW System Control Panel and the Xantrex XW Automatic Generator Start.

For this Topic	See....
"The Xantrex XW System Control Panel"	page 5-2
"The Xantrex XW Automatic Generator Start"	page 5-7

The Xantrex XW System Control Panel

The Xantrex XW Series Inverter/Charger can be controlled remotely by connecting a Xantrex XW System Control Panel (SCP). The Xantrex XW SCP is optional for single inverter systems. The Xantrex XW SCP is required for configuring systems with multiple inverters. The Xantrex XW SCP allows access to programming features of the inverter and allows the system to be modified to specific installation requirements.

The Xantrex XW SCP is connected to the inverter through one of two Xantrex Xanbus ports.

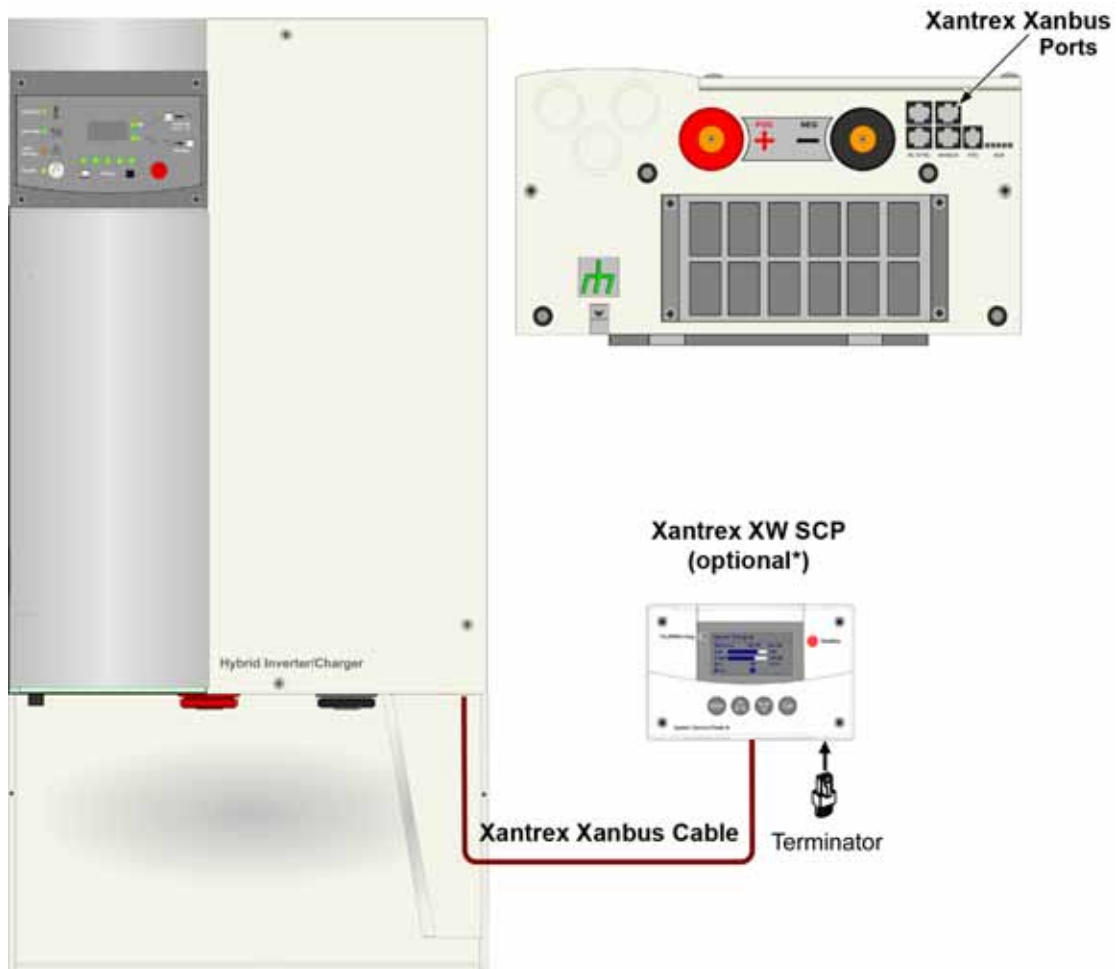

Figure 5-1 Xantrex XW System Control Panel Xantrex Xanbus Port Locations

The Xantrex XW SCP is designed to be wall mounted (see “Mounting the Xantrex XW System Control Panel” on page 5–4) and requires no connections other than the network cables or terminators that plug into the back of the unit.

Because you cannot access the Xantrex XW SCP network inputs after the unit is mounted, the network cables need to be routed through the wall and connected before securing the Xantrex XW SCP.

See Chapter 3, “Xantrex Xanbus Network Installation”, for more information about installing a Xantrex Xanbus-enabled device as part of a network-managed power system.

Materials and Tools Required

You will need these materials and tools to complete the installation:

- Mounting template sticker (supplied)
- Mounting plate (supplied)
- mounting plate (supplied)
- Four #6 screws (supplied)
- Two #8 screws (supplied)
- Cable clamps or hardware fasteners
- Schneider Electric network cables or equivalent (CAT 5 or CAT 5E cable with RJ45 connectors wired to T568A standard) A 7-foot cable is provided.
- Schneider Electric male network terminator (supplied).
- Phillips head screwdriver
- Jigsaw or small keyhole saw
- Power drill with 1/8" bit (optional)

Choosing a Location

Choose a location that is easily accessible. The Xantrex XW SCP should be mounted where you can have unobstructed access to the screen and buttons. The location should be indoors, dry, and free from corrosive or explosive fumes.



WARNING: Explosion hazard

The Xantrex XW System Control Panel is not Ignition Protected. Do not install in areas requiring Ignition-Protected equipment, such as areas containing gasoline engines, tanks, or fuel-line fittings.

Mounting the Xantrex XW System Control Panel

The Xantrex XW System Control Panel can be mounted three ways:

- Flush mounted through an opening in a wall using the mounting plate
- Surface mounted using the mounting plate
- Flush mounted through an opening in a wall and secured with four #6 screws.



WARNING: Shock hazard

Before making an opening in a wall or panel, make sure there is no wiring or other obstruction within the wall.

To flush mount the Xantrex XW System Control Panel with mounting plate:

1. Using a jigsaw and the supplied template sticker as a guide, cut out the hole for the mounting plate. The mounting plate fastens to walls up to 3/4 inch (19 mm) thick.
2. Route the network cable from the inverter inside the wall and through the opening.
3. Insert the mounting plate with the two tabs in a vertical position into the hole (see Figure 5-2).

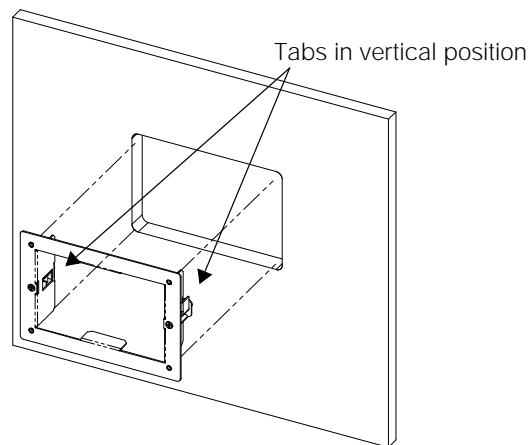

Figure 5-2 Inserting the Mounting Plate

4. Secure the mounting plate by tightening the two screws to rotate the tabs to the horizontal position (see Figure 5-3), and pull the tabs tight against the inner surface of the wall. Be careful not to overtighten the screws and damage the wall.

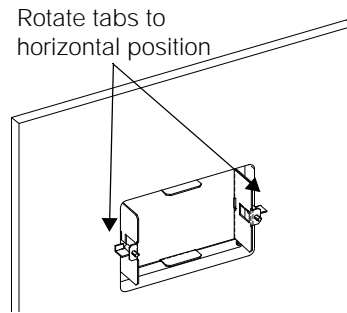

Figure 5-3 Securing the Mounting Plate

5. Connect the network cable(s) (and terminator if necessary) to either input on the back of the Xantrex XW SCP. See Figure 5-4. Connect a network terminator to the Xantrex XW SCP if it is the last device at the end of a series-type network layout.

Important: To ensure communication signal quality, the network must be terminated at each end with a terminator.

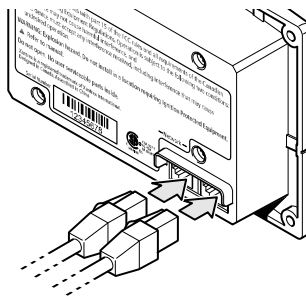

Figure 5-4 Connecting the Network Cables

6. Place the unit into the mounting plate and secure it with four #6 screws.

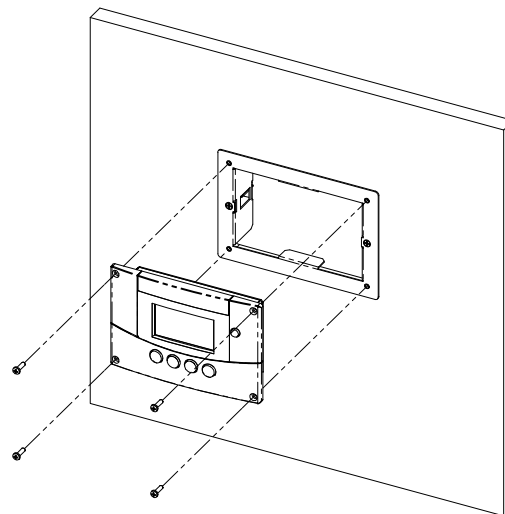

Figure 5-5 Securing the Xantrex XW System Control Panel

7. Peel off the protective plastic coating covering the screen and indicator light.

To flush mount the Xantrex XW System Control Panel with no mounting plate:

1. Peel the backing from the supplied mounting template sticker and place it in your chosen installation location. Use the template to mark the location for the area to be cut out.
2. Pilot-drill the mounting holes (if necessary, depending on your mounting surface) and, using a jigsaw, cut out the hole in which the Xantrex XW SCP will be inserted.
3. Route the network cable(s) from other Xantrex Xanbus-enabled devices inside the wall and through the opening.



CAUTION: Equipment damage

Connect the Xantrex XW System Control Panel only to other Xantrex Xanbus-enabled devices.

Although the cabling and connectors used in this network system are the same as Ethernet connectors, **this network is not an Ethernet system**. Equipment damage may result from attempting to connect these two different systems.

4. Connect the network cable(s) (and terminator if necessary) to either input on the back of the SCP. See Figure 5-4. Connect a network terminator to the Xantrex XW SCP if it is the last device at the end of a series-type network layout.
5. Place the unit in the opening and secure it with four #6 screws.
6. Peel off the protective plastic coating covering the screen and indicator light.

To surface mount the Xantrex XW System Control Panel:



CAUTION: Equipment damage

Provide adequate space within the wall for the Xantrex Xanbus cables to bend. Do not bend the cable to one side after it leaves the Xantrex Xanbus port. The mounting bracket itself does not provide enough space for the cables to bend. Attempting to route the cables through the side of the mounting bracket without providing space for the cables within the wall can result in damage to the Xantrex XW SCP Xantrex Xanbus ports and cause network communication problems.

1. Using the supplied template sticker as a guide, mark the locations for two mounting screws and the access hole for the network cables.
2. Using a hole saw, cut out the access hole for the network cable(s).
3. Route the network cable(s) from other Xantrex Xanbus-enabled devices inside the wall and through the access hole.
4. Attach the mounting plate with two #6 screws.

5. Connect the network cable(s) (and terminator if necessary) to either input on the back of the Xantrex XW SCP. Connect a network terminator to the SCP if it is the last device at the end of a series-type network layout.
6. Place the unit into the mounting plate and secure it with four #6 screws. See Figure 5-6.
7. Peel off the protective plastic coating covering the screen and indicator light.

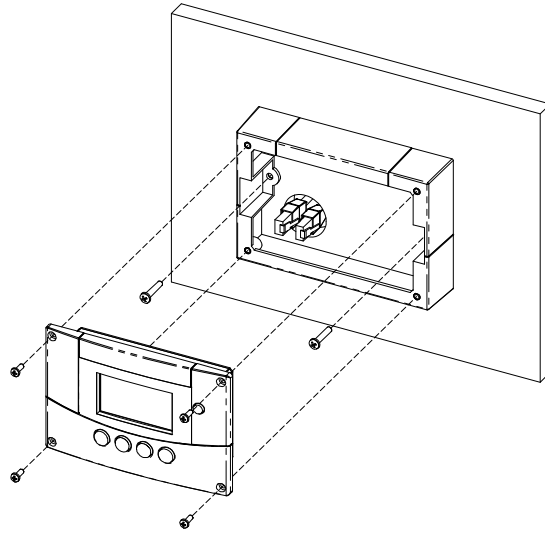

Figure 5-6 Surface Mounting the Xantrex XW System Control Panel

Verifying the Installation

If network power (from an inverter/charger) is present, the backlight will come on and the SCP will show the startup screen (see the *Xantrex XW Inverter/Charger Operation Guide*), then show the system Home screen.

The Xantrex XW Automatic Generator Start

Some generators allow automatic starting. Connecting a Xantrex XW Automatic Generator Start (Xantrex XW AGS) to the generator and to the Xantrex Xanbus network is required for the Xantrex XW Power System to benefit from automatic generator start/stop capability.



WARNING: Shock Hazard

Auto-start generators can start automatically at any time.

Affix the warning labels (supplied with the Xantrex XW Automatic Generator Start) regarding auto-start generators on or near the main utility panel and near the generator.

The Xantrex XW AGS connects to:

- Inverter/Charger's Xantrex Xanbus port
- Generator

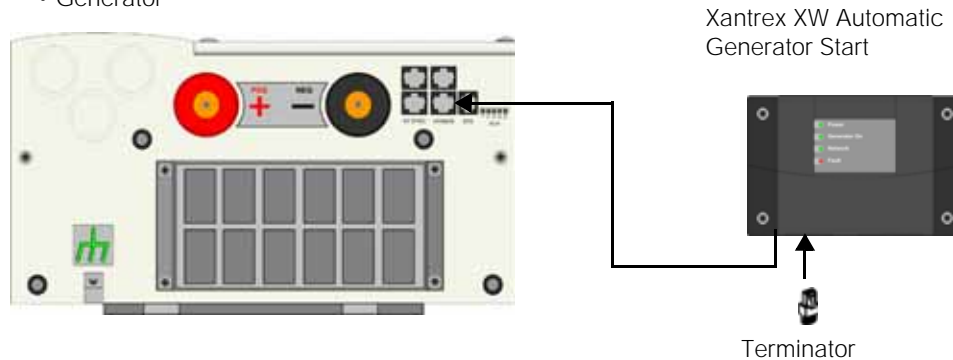

Figure 5-7 Connecting the Xantrex XW AGS Communications Cable to the Xantrex XW Series Inverter/Charger

Preparing an Installation

Before installing the Xantrex XW Automatic Generator Start Module, consider how and where the unit will be mounted. Pre-plan the connection routes between the Xantrex XW AGS, the generator, and the thermostats. Refer to the *Xantrex XW AGS Owner's Guide* for additional information.

See Chapter 3, "Xantrex Xanbus Network Installation", for more information about installing a Xantrex Xanbus-enabled device as part of a network-managed power system.

Materials and Tools Required

The following tools and materials may be needed to install the Xantrex XW AGS:

- Mounting template (supplied)
- Wiring harness
- Four #6 screws, 1¼ inch (supplied)
- #16 or #18 AWG wire (see "Wire Size and Length" on page 5-12)
- Manufacturer network cables or equivalent (Category 5)
- Network terminators (if required)
- Phillips screwdriver
- Wire cutters and wire strippers

Choosing a Location

The Xantrex XW AGS should be installed in a location that meets the following requirements:

- | | |
|---------------------------|--|
| Dry | The unit is intended for use in a dry location. The Xantrex XW AGS complies with UL458 Marine Supplement drip-test requirements, but the location should be as dry as possible. |
| Cool | The Xantrex XW AGS operates between -4 and 122 °F (-20 and 50 °C). |
| Safe | The Xantrex XW AGS is not ignition protected. Do not install it in areas requiring ignition-protected equipment, such as compartments housing gasoline engines. |
| Close to generator | Avoid excessive wire lengths and use the recommended wire lengths and sizes (see “Wire Size and Length” on page 5–12). It is more important for the Xantrex XW AGS to be close to the generator than to the inverter, although for safety reasons, the Xantrex XW AGS must not be installed in the same compartment as a gasoline-powered generator. |

Routing the Connections



WARNING: Explosion Hazard

This equipment is not ignition protected. To prevent fire or explosion, do not install the Xantrex XW Automatic Generator Start in locations that require ignition-protected equipment. This includes any space containing gasoline-powered machinery, fuel tanks, as well as joints, fittings, or other connections between components of a fuel system.

Follow all relevant instructions exactly before installing or using your Xantrex XW Automatic Generator Start.



WARNING: Shock and Energy Hazards

Before making any connections to the generator, ensure that the generator's starter is disabled and the generator's start battery is disconnected.

Connection Types

Because the Xantrex XW AGS will be part of a Xantrex Xanbus system, it is necessary to consider how to route two types of connections:

- connections to the generator, thermostats, and other external devices and switches, using the 20-contact connector and wiring harness.
- connections to other Xantrex Xanbus-enabled devices, using network cables.

For information on designing and installing the network, see the *Xantrex XW Inverter/Charger Operation Guide*.

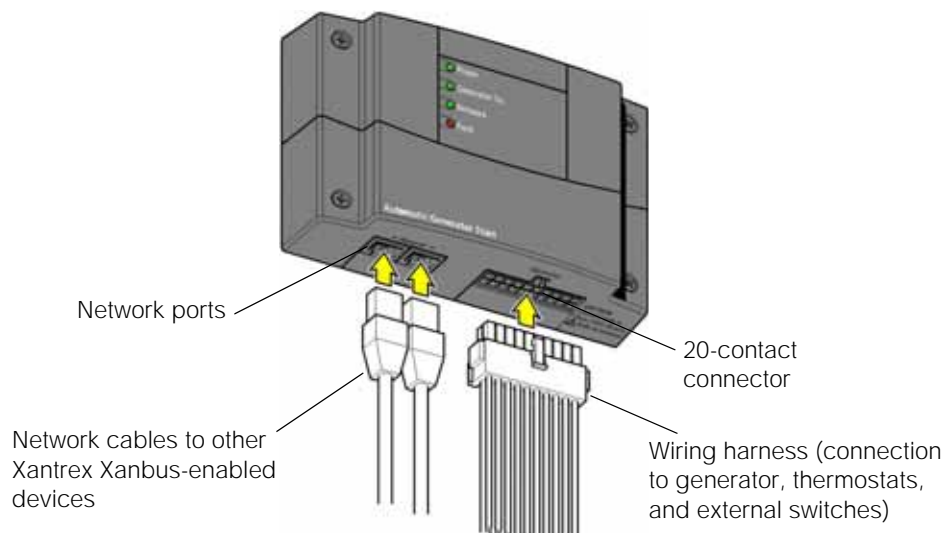

Figure 5-8 Xantrex XW Automatic Generator Start External Connections

Installing the Xantrex XW Automatic Generator Start

Installation Overview

Installing the Xantrex XW Automatic Generator Start involves the following steps:

1. Mounting the unit.
2. Connecting the wiring harness to:
 - the generator (page 5-14)
 - thermostats (optional) (page 5-15)
 - external shutdown switch (optional) (page 5-15)
 - external ON/OFF switch and LED (optional) (page 5-16)
3. Connecting the wiring harness to the 20-contact connector on the Xantrex XW AGS.
4. Connecting the Xantrex XW AGS to the Xantrex XW SCP and other network-enabled devices (page 5-18).

Important: Because each installation varies according to the location, the type of generator, and the overall complexity of the Xantrex Xanbus system, these instructions can offer only general guidelines for the many installation options available.



WARNING: Shock Hazard

Before installing the Xantrex XW Automatic Generator Start as part of a pre-existing Xantrex Xanbus system, put the system in standby in order to disable the electrical operation of networked devices. See the *Xantrex XW Automatic Generator Start Owner's Guide* for instructions on putting the system in standby.

Mounting the Unit

The Xantrex XW AGS must be mounted vertically on a wall with the connectors facing downwards.

To mount the Xantrex XW Automatic Generator Start:

1. Hold the unit flush and square against the wall, panel, or horizontal surface.
 - If the mounting surface requires pre-drill holes for the screws, use the supplied mounting template to mark, then drill, four holes.
2. With a Phillips screwdriver and the supplied #6 screws, secure each corner of the Xantrex XW AGS to the mounting surface.

Wiring to the 20-contact Connector



WARNING: Fire, Shock, and Energy Hazards

The 20-contact connector is intended for connection to Class 2 ELV (Extra Low Voltage) circuits only. Do not exceed the circuit limitations specified in the following section.



CAUTION: Shock Hazard

All installation wiring should be performed by a qualified installer or electrician.

ELV Circuits

ELV (Extra-Low Voltage) circuits have an open-circuit voltage of not more than 30 V_{rms} or 42.2 VDC or peak, and are therefore not a shock hazard.

Class 2 Circuits

As per the US National Electrical Code (NEC) and the Canadian Electrical Code (CEC), available power in Class 2 circuits is limited to 100 VA, usually by current limiting by means of overcurrent protection or series resistance. The current is limited to 5 A for circuits with open-circuit voltage of 20 V, and to $I=100/VOC$ for circuits with open circuit voltage between 20 V and 30 V.

Circuit Limitations The relay contacts in the Xantrex XW AGS are rated at 5 A maximum and all circuits on the 20-contact connector are rated at 30 V maximum. Make sure that all circuits connected to the 20-contact connector obey the following limits:

Table 5-1 Circuit Limitations

Circuit Parameter	Circuit Maximum
Open circuit voltage (VOC)	30 V maximum
Overcurrent protection (fuse size for open circuit voltage up to 20 V)	5 A maximum
Overcurrent protection (fuse size for open circuit voltage from 20 V to 30 V)	5 A to 3.33 A (100/VOC amps maximum)

Wiring Harness Connections to the generator, thermostats, and external ON/OFF switches are made using a wiring harness that plugs into the 20-contact connector (see Figure 5-8). The wires on the wiring harness can be extended to meet installation requirements. When extending the wire harness, make sure that the extension wires are the same color as the wires on the harness.

To install the Xantrex XW Automatic Generator Start using the wiring harness:

1. Connect each wire on the harness to its intended wire or contact on the generator, thermostats, or external switches.
2. Plug the harness into the connector on the bottom panel of the Xantrex XW AGS.

Wire Identification Each wire on the harness is identified by a number and a color. The wire numbers are shown in Figure 5-9 and their colors and functions are described in Table 5-3.

Wire Size and Length Required wire sizes for the external connections to the wiring harness are:

Table 5-2 Required Wiring Size Based on Length of Cable

0–30 ft. (9 m)	Over 30 ft. (9 m)
18 AWG	16 AWG

When planning the routing for external connections, make sure wire lengths are sufficient to plug the wiring harness into the Xantrex XW AGS once all the external connections are complete.

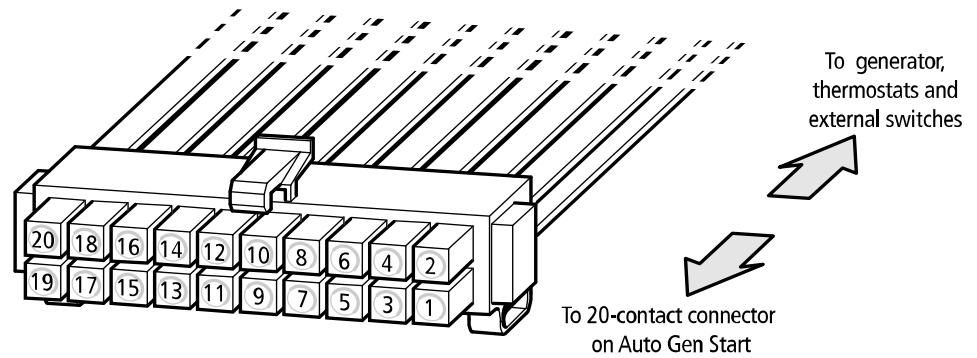

Figure 5-9 Xantrex XW Automatic Generator Start Wiring Harness

Table 5-3 Contact Numbers and Functions

Wire Number	Function	Wiring Harness Wire Color
1	Thermostat 1 input	Yellow
2	Thermostat 1 return	Gray
3	Thermostat 2 input	Orange
4	Thermostat 2 return	Gray
5	External shutdown input	White/Black
6	External shutdown return	Gray
7	External manual on input	White/Green
8	External manual off input	White/Red
9	External ON/OFF LED Indicator output	White/Blue
10	Constant 12/24 V B+ (battery positive) for External ON/OFF/LED Indicator	Red
11	External ON/OFF/LED Indicator return (connected internally to wire number 13)	Black
12	Generator run signal (switched B+) sense input	Violet
13	Generator run signal (switched B+) sense return (generator battery negative)	Black
14	Relay 1 (Generator run/stop) Normally open contact	Blue
15	Relay 1 (Generator run/stop) Normally closed contact	White/Violet
16	Relay 1 (Generator run/stop) Common contact	Gray
17	Relay 2 (Generator start) Normally open contact	White

Table 5-3 Contact Numbers and Functions

Wire Number	Function	Wiring Harness Wire Color
18	Relay 2 (Generator start) Common contact	Gray
19	Relay 3 (Preheat/cooldown) Normally open contact	Brown
20	Relay 3 (Preheat/cooldown) Common contact	Gray

Connecting the Generator

To connect the Xantrex XW AGS to a generator, you must identify the start wiring configuration of the generator you want to use. Generators must be auto-start capable, and generators equipped with remote operation connections are ideal.

If the generator is equipped for remote operation, you must examine the wiring of the remote cable and connector (or read your generator's documentation, if available) and identify the following wires:

- Ground
- Start
- Stop
- Generator run signal, also known as the Hour Meter or Switched B+ (battery positive)

Wiring requirements

To wire the Xantrex XW AGS to the generator, you need #16 or #18 AWG wire connected between contacts 12 to 20 on the wiring harness. How many of these wires you connect and in which combination depends on your generator type.

Generator types

The Xantrex XW AGS has 13 preset generator configurations, or GenType (see the *Xantrex XW Automatic Generator Start Owner's Guide* for details on generator types). To make sure that the Xantrex XW AGS is compatible with your generator's starting circuitry, you must select your type of generator from the Xantrex XW AGS menu on the Xantrex XW SCP after completing the installation.

Important: You can only change GenType after you have put the system or the Xantrex XW Automatic Generator Start into standby mode. See the *Xantrex XW Inverter/Charger Operation Guide* for instructions on putting the system in standby mode.

This section describes the generator configurations and provides diagrams for connecting the wiring harness to the generator's start wiring.

Important: For an explanation of the terminology used in the following section, refer to Appendix B of the *Xantrex XW Automatic Generator Start Owner's Guide*. For more information about Xantrex XW Automatic Generator Start internal relay activity and timing, see the *Xantrex XW Automatic Generator Start Owner's Guide*.

Connecting the Thermostats (Optional)

Wires 1, 2, 3, and 4 on the wiring harness can be connected to two thermostats. Wires 1 (yellow) and 2 (gray) are intended for thermostat 1 and wires 3 (orange) and 4 (gray) are intended for thermostat 2.

Table 5-4 Wiring for Connecting Thermostats

Wire Number	Function	Wiring Harness Wire Color
1	Thermostat 1 input (12/24 V)	Yellow
2	Thermostat 1 return (ground)	Gray
3	Thermostat 2 input (12/24 V)	Orange
4	Thermostat 2 return (ground)	Gray

These wires connect to 12 volt/24 volt output signals from the thermostats. The Xantrex XW AGS will start the generator in response to these signals. Thermostats cannot be programmed using the Xantrex XW AGS. For specific information about thermostat wiring and where Xantrex XW AGS connections should be made, please consult your thermostat documentation or contact the thermostat manufacturer.

Connecting an External Shutdown (Optional)

The external shutdown input is a 12 volt/24 volt input used to make sure the Xantrex XW AGS keeps the generator off under conditions that may be potentially hazardous. Wire 5 (white/black) and 6 (gray) on the wiring harness are intended for an external switch or sensor (such as a moisture detector, carbon monoxide detector or coach running signal) that produces an active high 12 volt or 24 volt output.

Table 5-5 Wiring for Connecting an External Shutdown

Wire number	Function	Wiring Harness Wire Color
5	External shutdown input (12/24 V)	White/Black
6	External shutdown return (ground)	Gray

Connecting an External Manual ON/OFF Switch (Optional)

The external manual ON/OFF inputs (wires 7 and 8 on the wiring harness) are intended for wiring to one or more remote ON/OFF switches for starting and stopping the generator manually. The other contact of the switch should be connected to ground. In order for the Xantrex XW AGS to be able to detect these switches, wire the positive of the generator battery to the constant 12 volt/24 volt generator battery positive (wire 10 on the Xantrex XW AGS wiring harness). See Figure 5-7.

If the generator battery does not have the required voltage, any 12 volt or 24 volt power source will suit this purpose. If an alternate power source is used, the negative of the power source must be connected to the other contact of the switch.



CAUTION: Equipment Damage

Do not connect the Xantrex XW Automatic Generator Start to a 48 volt battery bank. The Xantrex XW Automatic Generator Start is limited to a 30V open-circuit maximum by its regulatory approval and cannot be connected to a 48 volt power source. Furthermore, tapping 12-volts or 24-volts from a 48 volt battery bank will unevenly wear out the batteries and shortens the battery bank life.

Table 5-6 Wiring for Connecting an External Manual ON/OFF Switch

Wire Number	Function	Wiring Harness Wire Color
7	External manual on input	White/Green
8	External manual off input	White/Red
9	External ON/OFF LED Indicator output	White/Blue
10	Constant 12/24 V B+ for External ON/OFF/LED Indicator	Red
11	External ON/OFF/LED Indicator return	Black

Multiple control panels or simple contact closures can be wired to the external manual ON/OFF inputs. The Xantrex XW AGS detects if any of the contacts close and will change its operating mode to External Manual On or External Manual Off (for more information, see the *Xantrex XW Automatic Generator Start Owner's Guide*). The Xantrex XW AGS turns the generator on or off according to these inputs and the resulting operating mode change. The External Manual On and External Manual Off states are not affected by maximum generator run time. See the *Xantrex XW Automatic Generator Start Owner's Guide* for additional information.

Connecting an External ON/OFF LED

Wires 9 (White/Blue) and 11 (Black) on the wiring harness can be connected to an LED or other light to accompany a remote external ON/OFF switch. This light turns on when the generator run signal is active to visually indicate that the generator is running.

Important: With some generators, the generator run signal becomes active during the preheat stage, before the generator is actually running. In this case, the external ON/OFF LED (and the Generator On light on the Xantrex XW Automatic Generator Start) will turn on during the preheat stage and remain on when the generator is running.

For some generators, these lights will also remain on for a period of time after the generator has stopped.

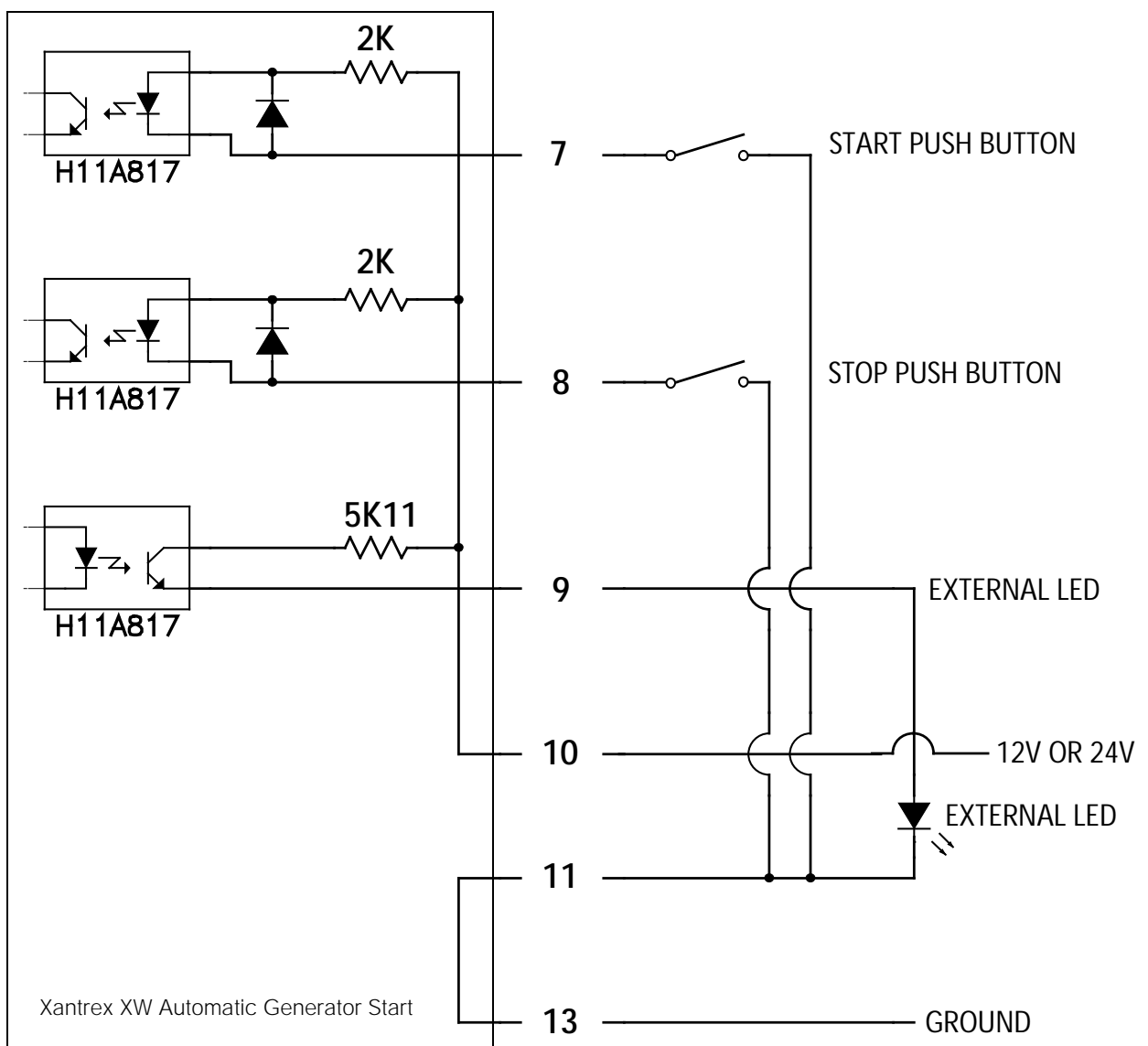

Figure 5-10 External ON/OFF Switch and LED Wiring Diagram

Connecting the Wiring Harness to the Xantrex XW Automatic Generator Start

After all the external connections have been wired to the wiring harness, the connector on the wiring harness must be plugged into the 20-contact connector on the Xantrex XW AGS.

To connect the wiring harness to the Xantrex XW Automatic Generator Start:

- ◆ With the click-tab on the wiring harness connector on top (away from the mounting surface), insert the wiring harness connector into the 20-contact connector on the Xantrex XW AGS until the tab clicks into place.

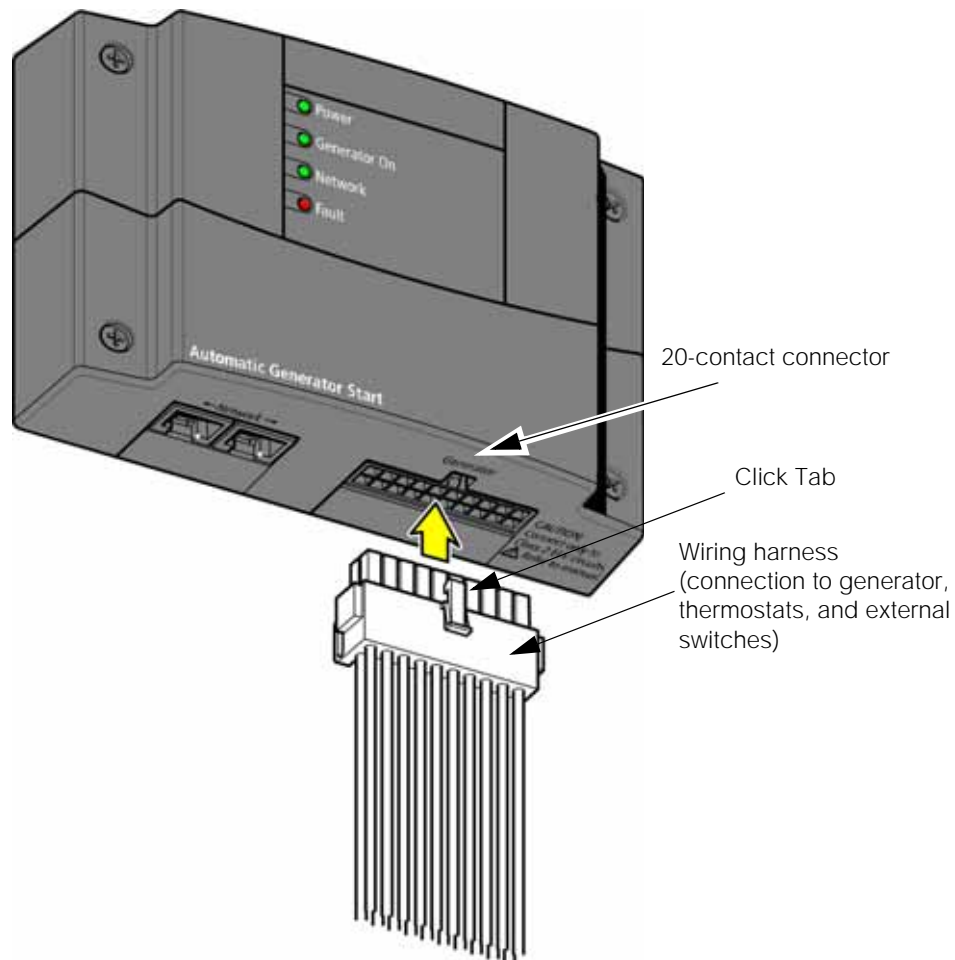

Figure 5-11 Xantrex XW Automatic Generator Start External Connections

Connecting the Xantrex XW Automatic Generator Start to the Xantrex Xanbus Network



CAUTION: Equipment Damage

Connect only to other Xantrex Xanbus-enabled devices. Although the cabling and connectors used in this network system are the same as Ethernet connectors, **this network is not an Ethernet system**. Equipment damage may result from attempting to connect a Xantrex Xanbus-enabled device to an Ethernet system.

To connect the Xantrex XW AGS to the Xantrex Xanbus network, plug a Category 5 network cable into one of the network ports on the bottom panel of the Xantrex XW AGS. Connect the other end of that same cable to any Xantrex Xanbus-enabled component that has an available network port. See Figure 5-8 on page 5–10 for the location of the ports on the Xantrex XW AGS.

If the Xantrex XW AGS is being installed on an existing Xantrex Xanbus system, the system must first be put into standby. See the *Xantrex XW Automatic Generator Start Start Owner's Guide* for instructions.

Depending on the layout of the Xantrex Xanbus system, the following options are available for the other network connector on the Xantrex XW AGS:

- A second network cable (in a daisy-chain network layout)
- A network terminator (in a daisy chain network layout where the Xantrex XW AGS is the last device at one end of the network)
- Nothing (in a multi-drop backbone layout)

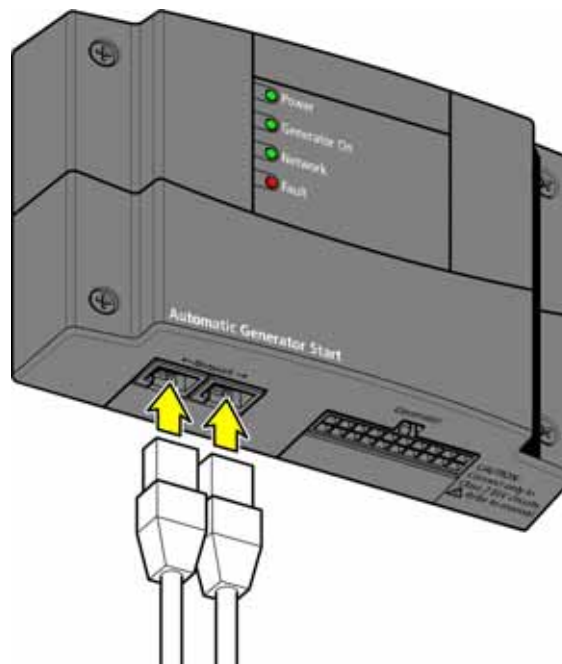

Connect 1 or 2 Category 5 network cables as required by the installation configuration.

Figure 5-12 Connecting the Xantrex XW SCP

Verifying Power Is Available

When the Xantrex XW AGS has been installed properly, the Power and Network indicator lights turn on. If one or both lights are out, check the network connections and ensure the network power supply is on.

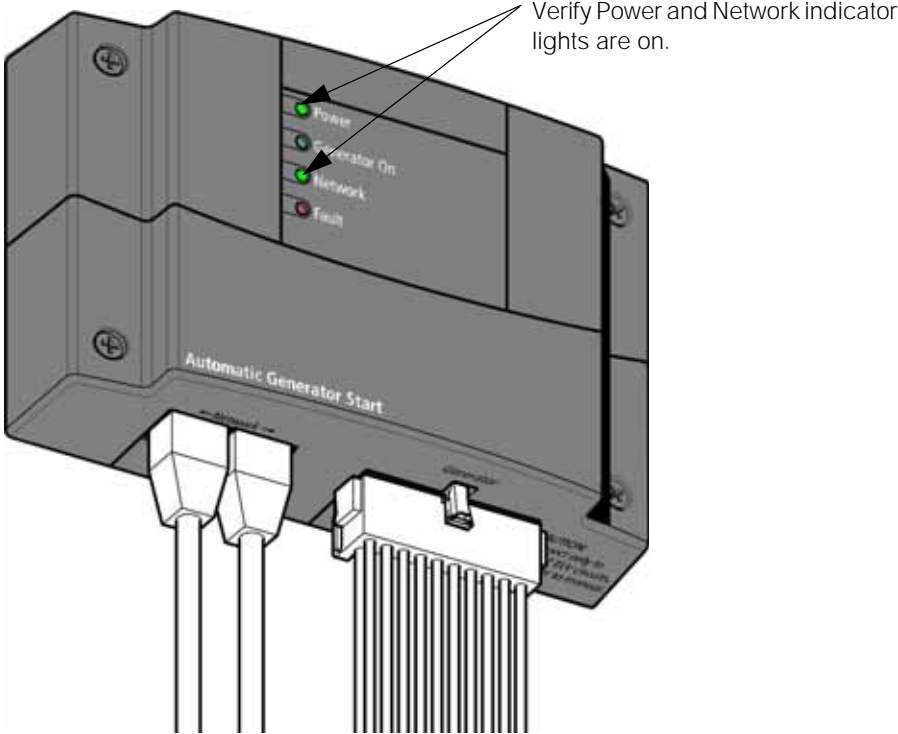

Figure 5-13 Verifying Power is Available

A

Specifications

Appendix A, "Specifications" provides the electrical and environmental specifications for the Xantrex XW Series Inverter/Charger.

Electrical Specifications

Table A-1 Xantrex XW Power System Electrical Specifications

Model	Xantrex XW6048 120/240 60	Xantrex XW4548 120/240 60	Xantrex XW4024 120/240 60
Continuous Output Power	6,000 W	4,500 W	4,000 W
Surge Rating (10 seconds) (stand-alone invert mode)	12,000 W (15 s)	9,000 W (20 s)	8,000 W (20 s)
Surge Current (stand-alone invert mode)	L-N: 105 A _{rms} (15 s) L-L: 52.5 A _{rms} (15 s)	L-N: 75 A _{rms} (20 s) L-L: 40 A _{rms} (20 s)	L-N: 70 A _{rms} (20 s) L-L: 35 A _{rms} (20 s)
Waveform	True Sine Wave		
Idle Consumption—invert mode, no load	28 W	26 W	24 W
Idle Consumption—search mode	< 8 W		
AC Output Voltage	L-N: 120 VAC ±3% L-L: 240 VAC ±3%		
AC Input voltage range (Bypass/Charge Mode)	L-N: 80–150 VAC (120 V nominal) L-L: 160–270 VAC (240 V nominal)		
AC Input Current (maximum 75% imbalance between L1-N, L2-N)	L-N: 41.2 A L-L: 27.5 A	L-N: 30.9 A L-L: 20.6 A	L-N: 27.5 A L-L: 18.3 A
AC Input Breaker	60 A double-pole		
AC Input Frequency Range (Bypass/Charge Mode)	55–65 Hz (default) 44–70 Hz (allowable)		
AC1 voltage range—Grid-tie Sell Mode ^a (automatically adjusts when entering Grid-tie Sell Mode)	L-N: 108–130 ±1.5 VAC L-L: 214–260 ±3.0 VAC		
AC1 Frequency range—Grid-tie Sell Mode ^a (automatically adjusts when entering Grid-tie Sell Mode)	59.4–60.4 ±0.05 Hz		
AC Output Current (maximum 75% imbalance between L1-N, L2-N) in Inverter Mode	L-N: 37.5 A L-L: 25.0 A	L-N: 28.1 A L-L: 18.8 A	L-N: 25.0 A L-L: 16.7 A
Maximum Output Fault Current and Duration - Charger Mode	5,150 A peak ~1 ms	5,150 A peak ~1 ms	6500 A peak ~1 ms
Maximum Output Fault Current and Duration - Inverter Mode	925 A peak ~0.5 ms	925 A peak ~0.5 ms	25 A peak ~330 ms

Table A-1 Xantrex XW Power System Electrical Specifications

Model	Xantrex XW6048 120/240 60	Xantrex XW4548 120/240 60	Xantrex XW4024 120/240 60
Maximum Output Fault Current and Duration - Grid-Interactive Mode	425 A peak ~0.4 ms	425 A peak ~0.4 ms	80 A peak ~25 ms
AC Output Breaker	60 A double-pole		
AC Output Frequency	60.0 ±0.1 Hz		
Total Harmonic Distortion	< 5%		
Automatic Transfer Relay	60 A		
Auxiliary Relay Output	0–12 VDC, maximum 250 mA DC		
CEC Weighted Efficiency	92.5%	93.0%	91%
CEC Power Rating	5,752 W	4,453 W	4,039 W
DC Input Voltage (Nominal)	50.4 VDC	50.4 VDC	25.2 VDC
DC Input Voltage Range	40–64 VDC	40–64 VDC	20–32 VDC
DC Input Current (Maximum)	160 A	120 A	220 A
Continuous Charge Rate at L-L voltage	100 A	85 A	150 A
Power Factor Corrected Charging	PF (0.98)		

a.This unit or system is provided with fixed trip limits and shall not be aggregated above 30 kW on a single Point of Common Connection

Grid-tie Specifications

	120/240 V	120 V	Response Time
Anti-islanding reconnect	254.4 V (± 3 V)	127.2 V (± 3 V)	300 s (+1/–0 s)
Over frequency disconnect	60.5 Hz (± 0.05 Hz)	60.5 Hz (± 0.05 Hz)	60 ms (± 20 ms)
Under frequency disconnect	59.3 Hz (± 0.05 Hz)	59.3 V (± 0.05 Hz)	60 ms (± 20 ms)
Over voltage LN fast disconnect	135 V (± 1.5 V)	135 V (± 1.5 V)	60 ms (± 25 ms)
Over voltage LN slow disconnect	132 V (± 1.5 V)	132 V (± 1.5 V)	500 ms (± 25 ms)
Over voltage L1/L2 fast disconnect	270 V (± 3 V)	–	60 ms (± 25 ms)
Over voltage L1/L2 slow disconnect	264 V (± 3 V)	–	500 ms (± 25 ms)
Under voltage LN fast disconnect	75 V (± 5 V)	75 V (± 5 V)	100 ms (± 25 ms)
Under voltage LN slow disconnect	105.6 V (± 1.5 V)	105.6 V (± 1.5 V)	1000 ms (± 25 ms)
Under voltage L1/L2 slow disconnect	211.2 V (± 3 V)	–	100 ms (± 25 ms)
Under voltage L1/L2 fast disconnect	150 V (± 10 V)	–	60 ms (± 25 ms)

Xantrex XW Series Inverter/Charger Overload Capability

Loads presented to the inverter are seldom constant. Typically, large loads are operated for only short periods of time. In order to provide the maximum utility, the inverters are allowed to operate at power levels that exceed their continuous power ratings. This graph shows how loads that are larger than the inverter can sustain continuously can be operated for useful periods of time.

The length of time that the inverter can operate at high power is limited by temperature. When large loads are run, the inverter's temperature increases. At the point where more heat is created in the inverter than can be dissipated, its ability to operate becomes time limited.

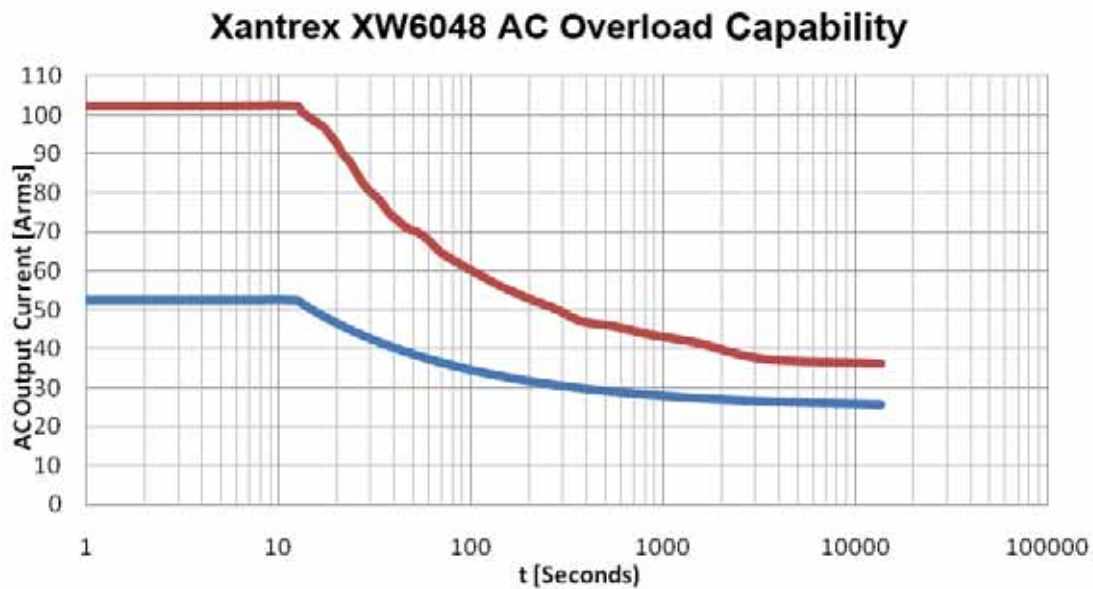

Figure A-1 Xantrex XW6048 120/240 60 AC Overload Capability

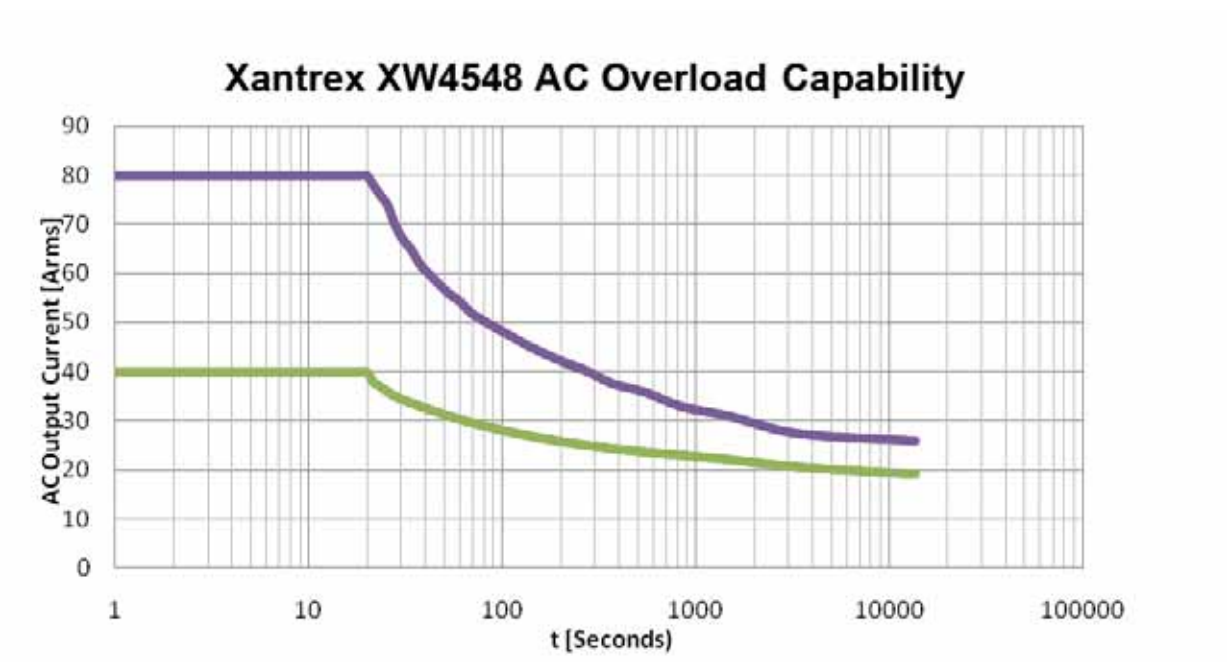

Figure A-2 Xantrex XW4548 120/240 60 AC Overload Capability

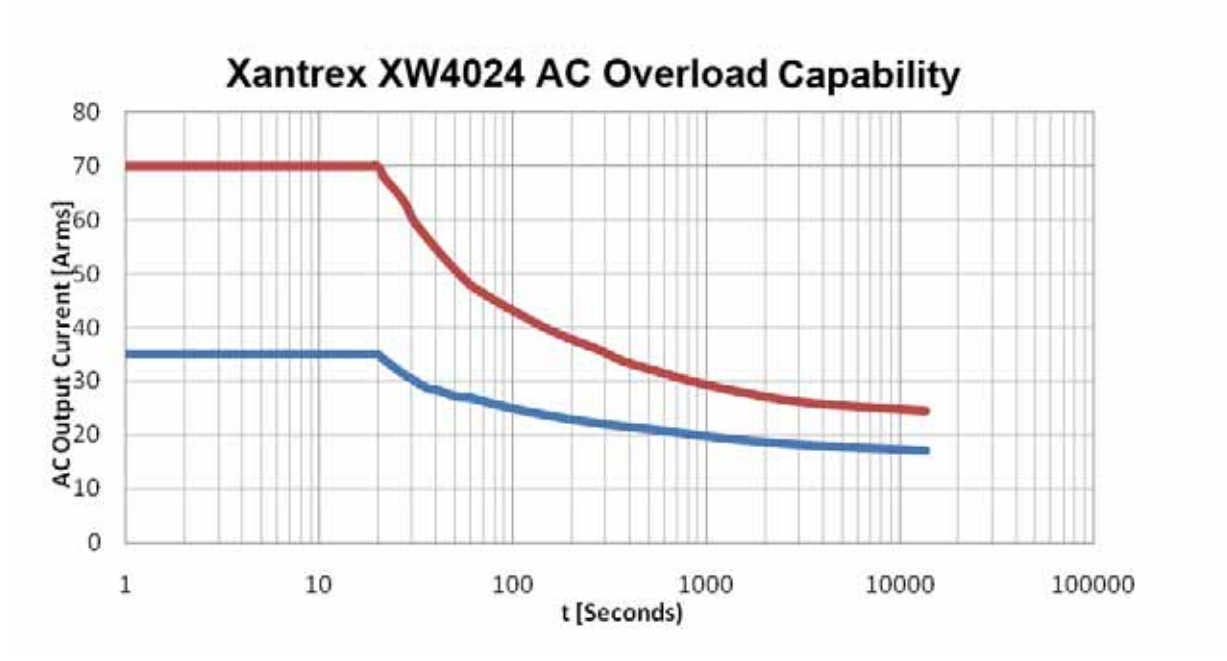

Figure A-3 Xantrex XW4024 120/240 60 AC Overload Capability

Output Power Versus Ambient Temperature

When the internal temperature of the Xantrex XW Series Inverter/Charger exceeds its rated range, the unit reduces its energy output to make sure maximum component ratings are not exceeded.

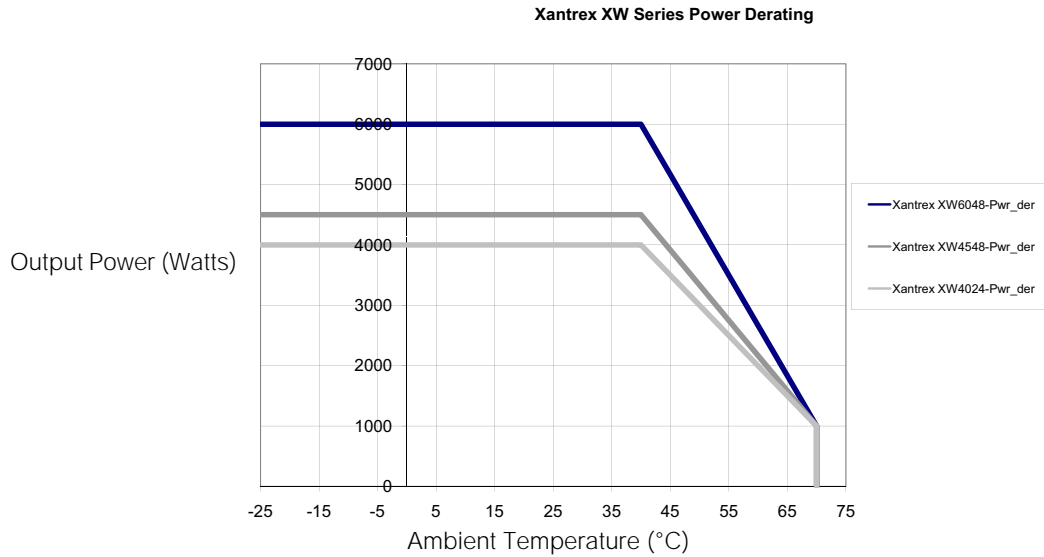

Figure A-4 Output Power Versus Ambient Temperature

Xantrex XW Series Inverter/Charger Efficiency Inverting Efficiency (Typical)

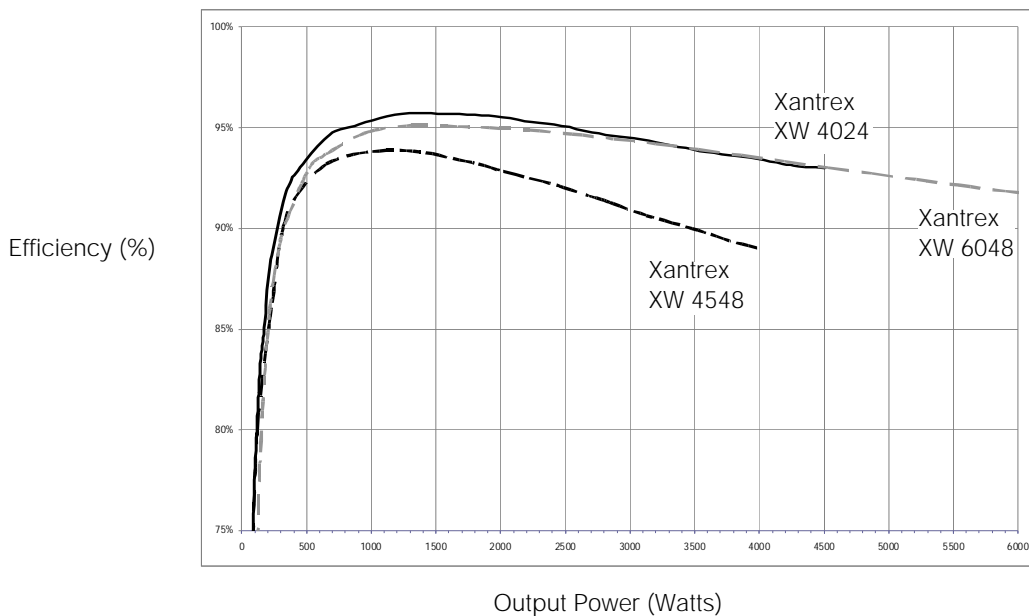

Figure A-5 Inverting Efficiency (Typical)

Charging Efficiency (Typical)

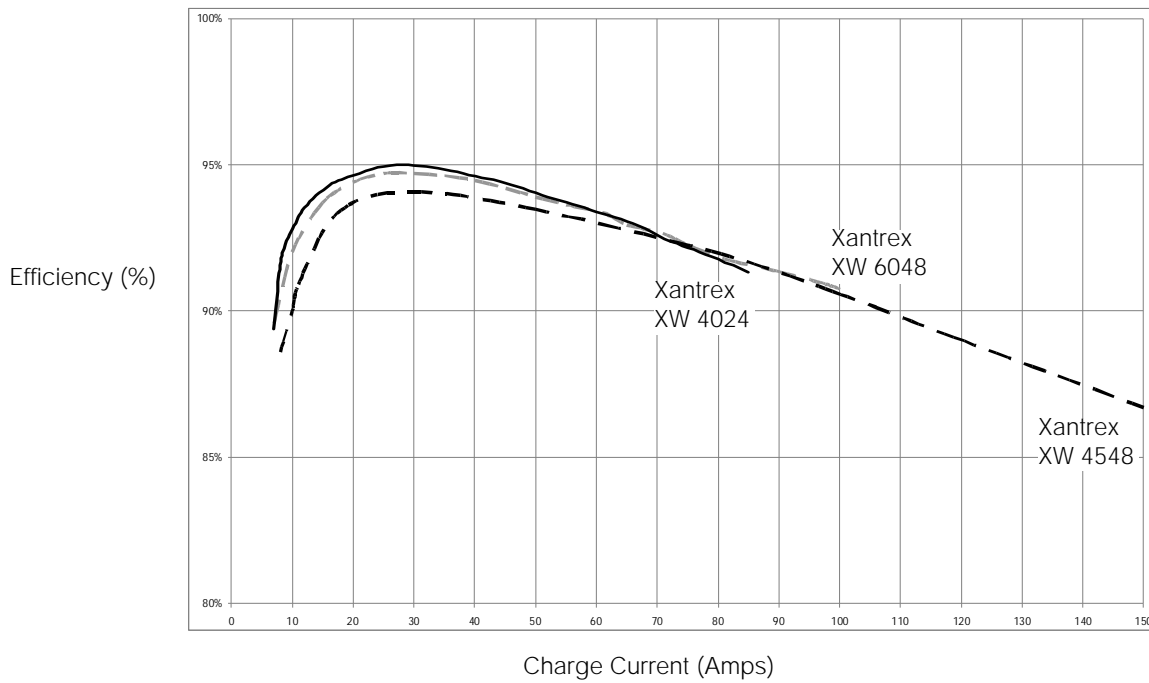

Figure A-6 Charging Efficiency (Typical)

Charging Power Factor

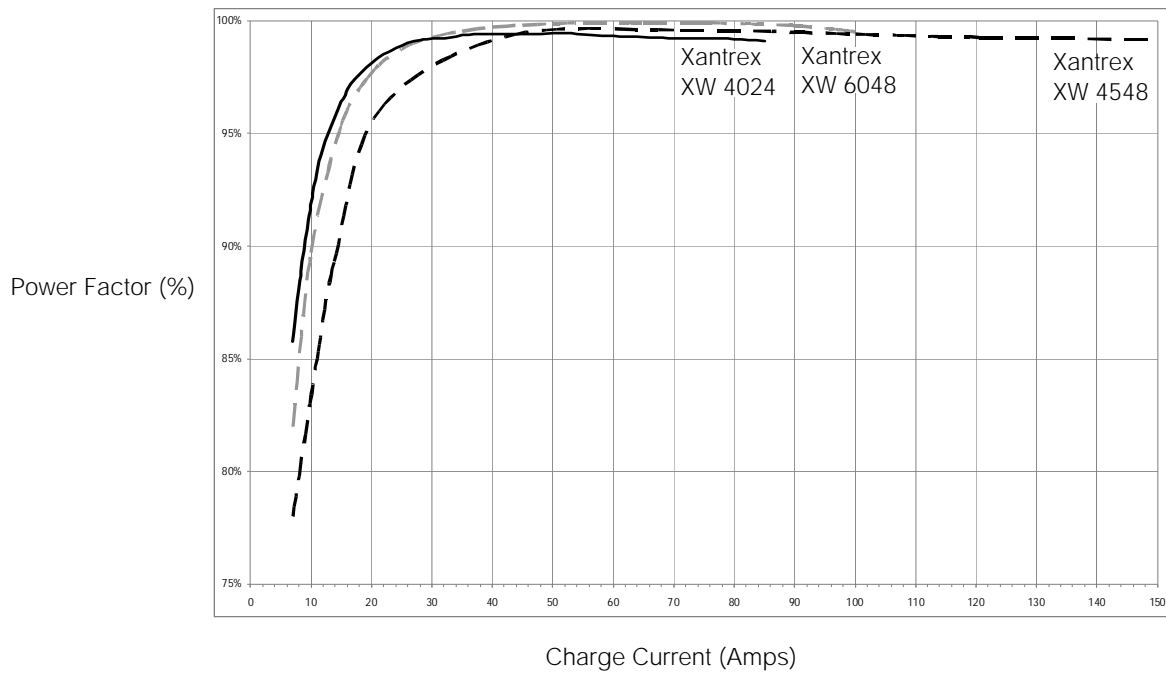

Figure A-7 Charging Power Factor

Grid-tie Sell Mode Efficiency (Typical)

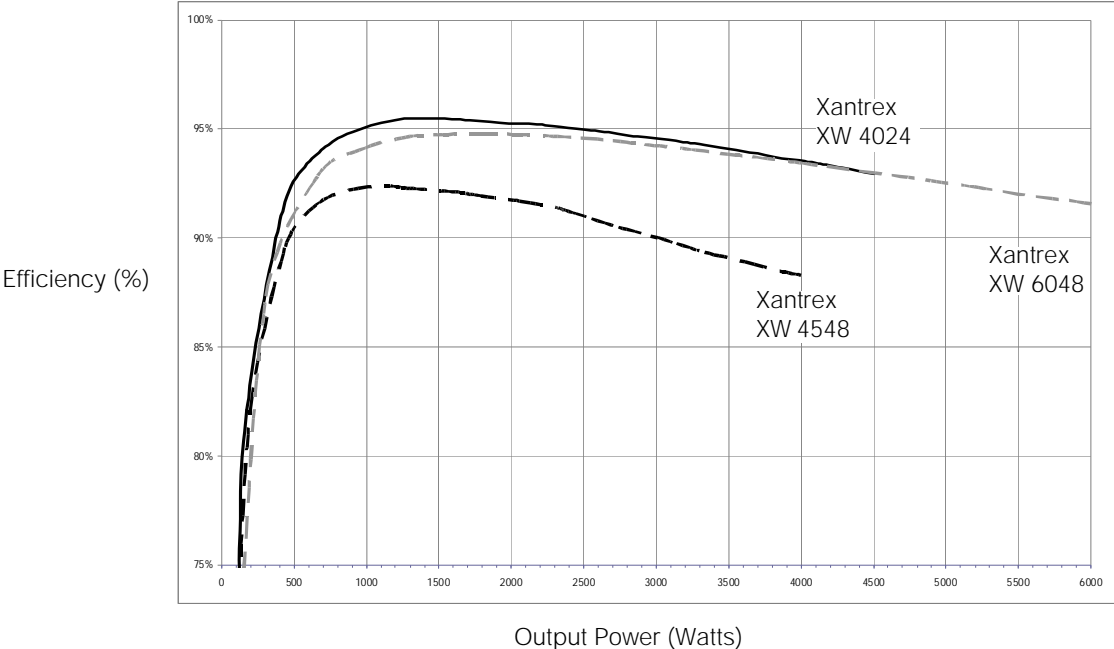

Figure A-8 Grid-tie Sell Mode Efficiency (Typical)

Mechanical Specifications

Table A-2 Xantrex XW Power System Mechanical Specifications

Model	Xantrex XW 6048 120/240 60	Xantrex XW 4548 120/240 60	Xantrex XW 4024 120/240 60
Supported Battery Types	Flooded (default), Gel, AGM, Custom		
Battery bank size	100–2000 Ah		
Non Volatile Memory	Yes		
Inverter Information Panel	<p>Status LEDs indicate AC In status, faults/warnings, equalize mode, battery level.</p> <p>Three-character display indicates output power or charge current, fault/warning codes.</p> <p>ON/OFF and equalize button</p>		
Multiple Unit Configurations	Up to 3 parallel units in 120/240 split-phase configuration		
System Network	Xantrex Xanbus (publish-subscribe network, no need for hubs or special cards)		
Emissions	FCC Class B		
Regulatory approvals	UL 1741 1st Edition: 2005 Version, CSA 107.1-01		
Enclosure Type	NEMA Type 1 - Indoor (sensitive electronic components sealed inside enclosure)		
Rated Temperature Range (meets all specifications)	32–104 °F (0–40 °C)		
Operational Temperature Range	-13–158 °F (-25–70 °C)		
Storage Temperature Range	-40–185 °F (-40–85 °C)		
Inverter Dimensions (H × W × D)	23 × 16 × 9" (580 × 410 × 230 mm)		
Shipping Dimensions	28 x 22.5 x 15.5" (711 x 572 x 394 mm)		
Xantrex XW Power Distribution Panel Dimensions (H × W × D)	30 × 16 × 8¼" (761 × 406 × 210 mm) Depth from the wall = 8 ¾" (223 mm)		
Xantrex XW Power Distribution Panel Shipping Dimensions	48 x 21 x 13.5" (1219 x 533 x 343 mm)		
Inverter Weight	121.7 lb (55.2 kg)	118 lb (53.5 kg)	116 lb (52.5 kg)
Shipping Weight	169 lb (76.7 kg)	165 lb (75 kg)	163 lb (74 kg)

Specifications

Table A-3 Xantrex XW Power System Regulatory Approvals

Model	Xantrex XW 6048 120/240 60	Xantrex XW 4548 120/240 60	Xantrex XW 4024 120/240 60
Emissions	FCC Class B		
Regulatory approvals	UL 1741 1st Edition: 2005 Version, CSA 107.1-01		
Surge Rating	IEEE 62.41.2 IEEE Recommended Practice on the Characterization of Surges in low-voltage AC power circuits (Location Category B)		

Accessories

Accessory	Part Number
Xantrex XW Power Distribution Panel	865-1015
Xantrex XW Conduit Box	865-1025
Xantrex XW Connection Kit for INV2	865-1020
Xantrex XW Solar Charge Controller	865-1030
Xantrex XW System Control Panel	865-1050
Xantrex XW Automatic Generator Start	865-1060
Network cables	3 ft (0.9 m): 809-0935 25 ft (7.6 m): 809-0940 75 ft (22.9 m): 809-0942
Network terminator	100-0224-01-01

B

Wiring Diagrams

Appendix B, “Wiring Diagrams” illustrate the most basic configurations and are for reference only. Specific installations may require additional equipment to meet national or local electric codes. Ensure all safety requirements are strictly followed.

For.....	See....
“Single-Inverter System (Backup Only) Without a Power Distribution Panel”	page B-3
“Single-Inverter System Renewable Energy (Solar)”	page B-5
“Single-Inverter System Renewable Energy (Wind or Hydro)”	page B-6
“Dual-Inverter System Renewable Energy (Solar)”	page B-7
“Dual-Inverter System Renewable Energy (Wind or Hydro)”	page B-8

Single-Inverter System (Backup Only) Without a Power Distribution Panel

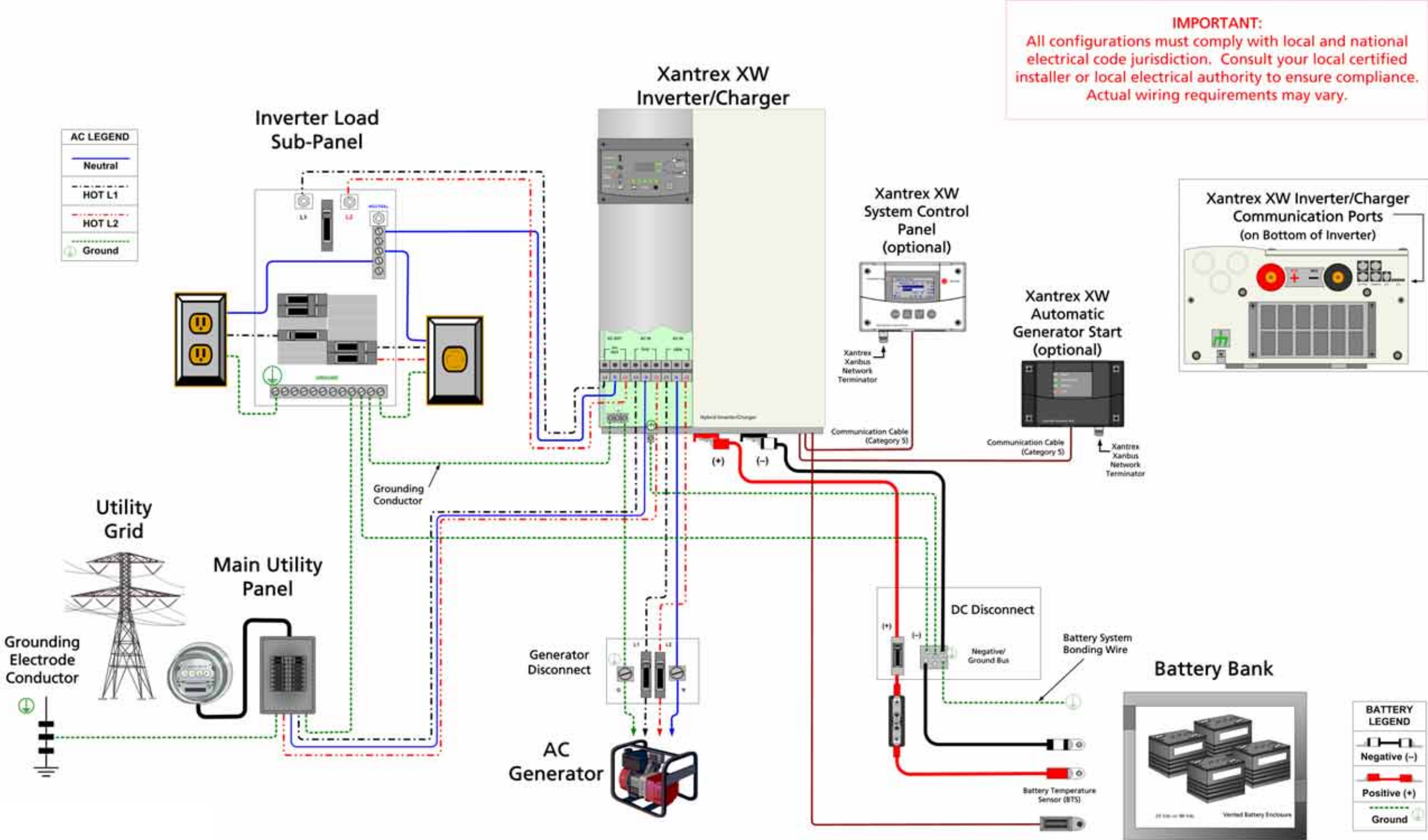

Figure B-1 Single-Inverter System (Backup Only) Without a Power Distribution Panel

Single-Inverter System (Backup Only) With a Power Distribution Panel

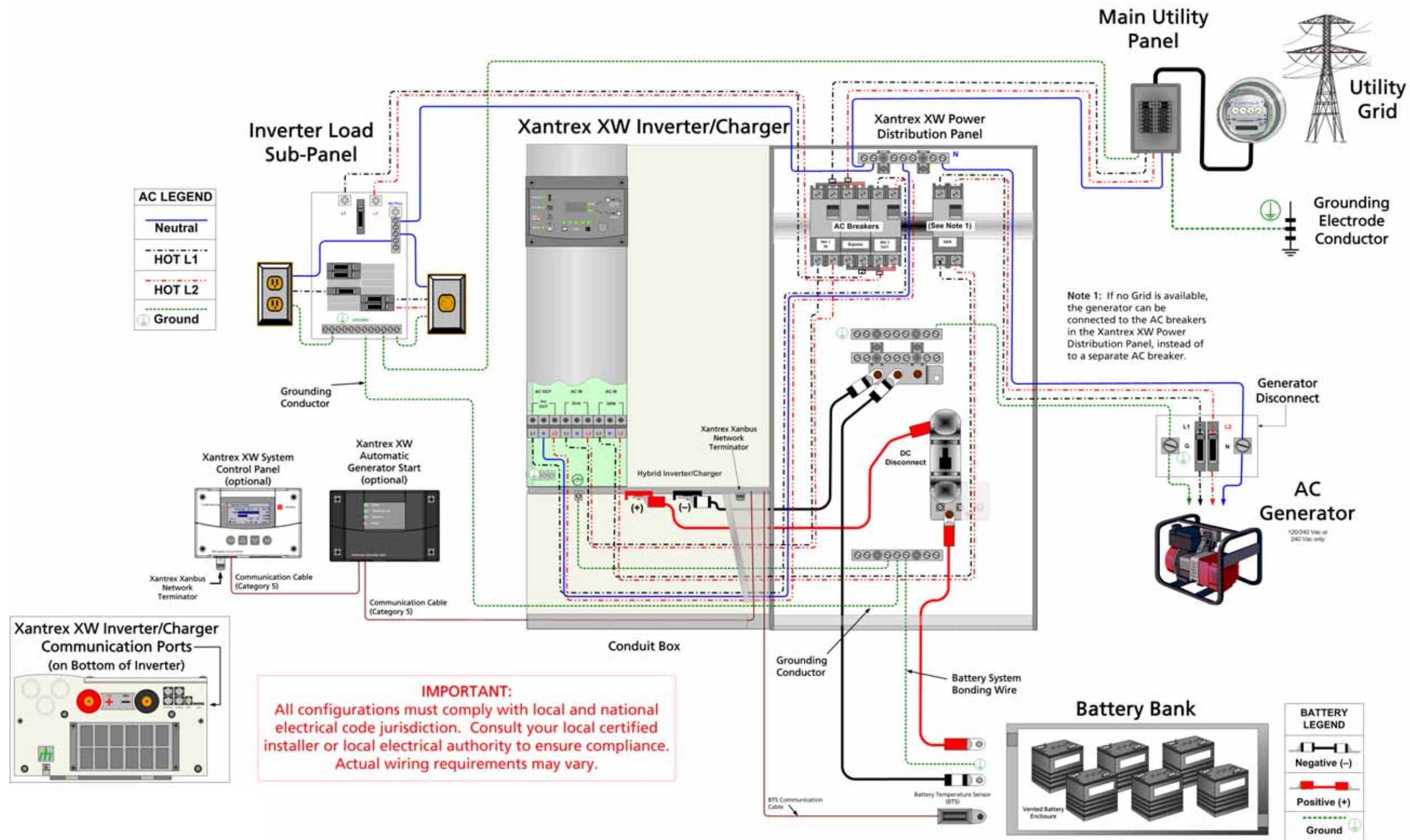

Figure B-2 Single-Inverter System (Backup Only) With a Power Distribution Panel

Single-Inverter System Renewable Energy (Solar)

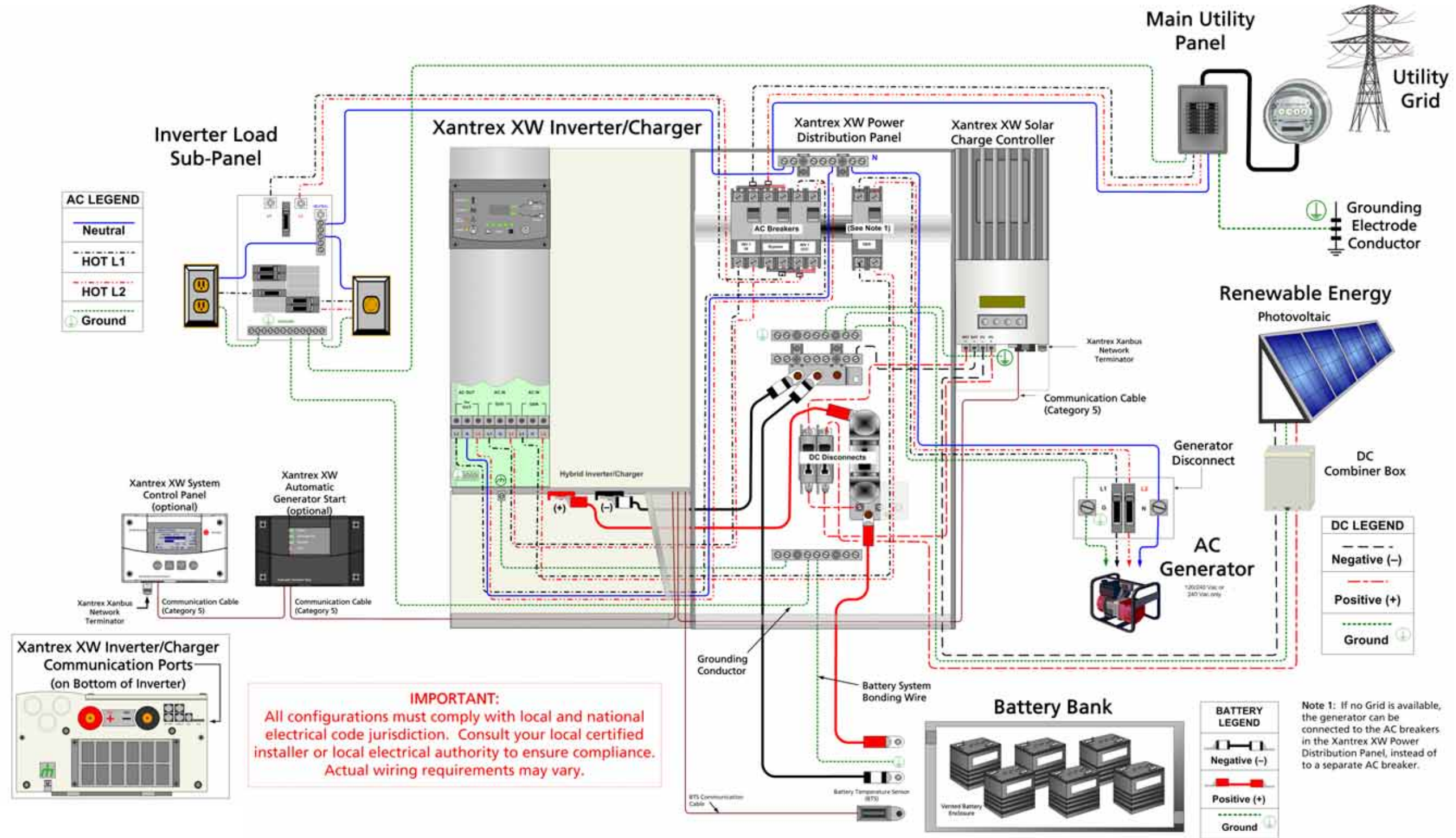

Figure B-3 Single-Inverter System Renewable Energy (Solar)

Single-Inverter System Renewable Energy (Wind or Hydro)

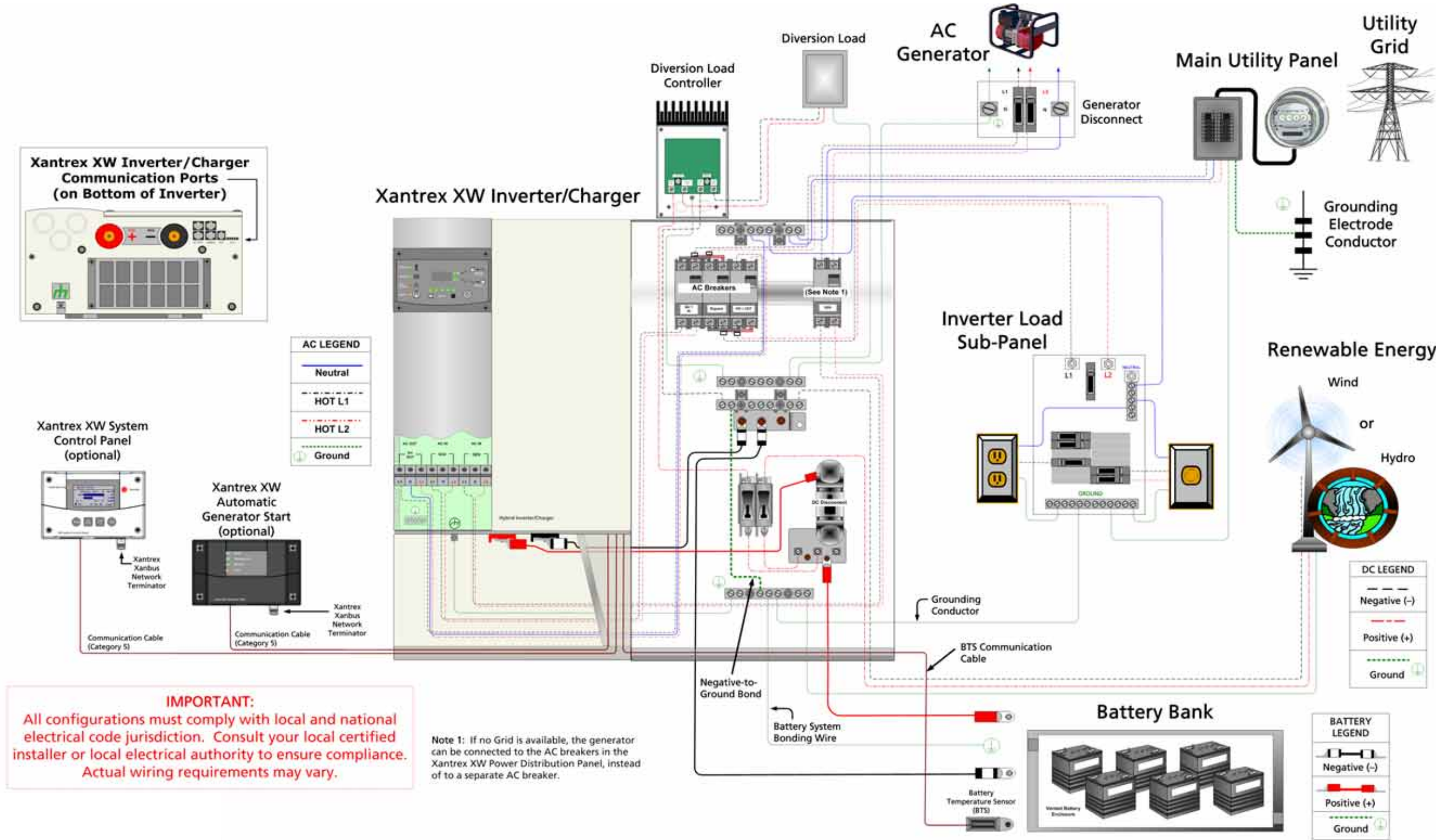

Figure B-4 Single-Inverter System Renewable Energy (Wind or Hydro)

Dual-Inverter System Renewable Energy (Solar)

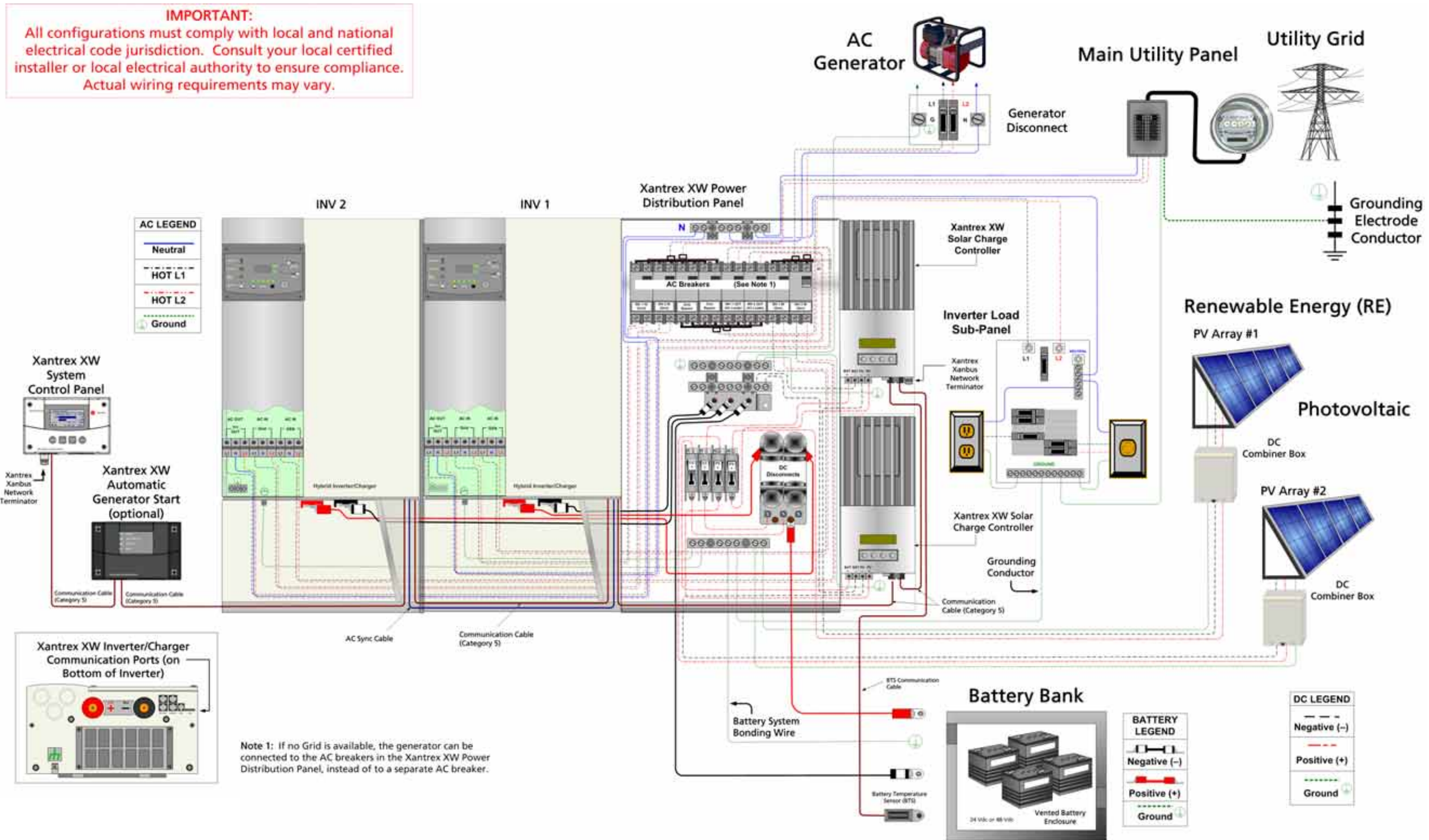

Figure B-5 Dual-Inverter System Renewable Energy (Solar)

Dual-Inverter System Renewable Energy (Wind or Hydro)

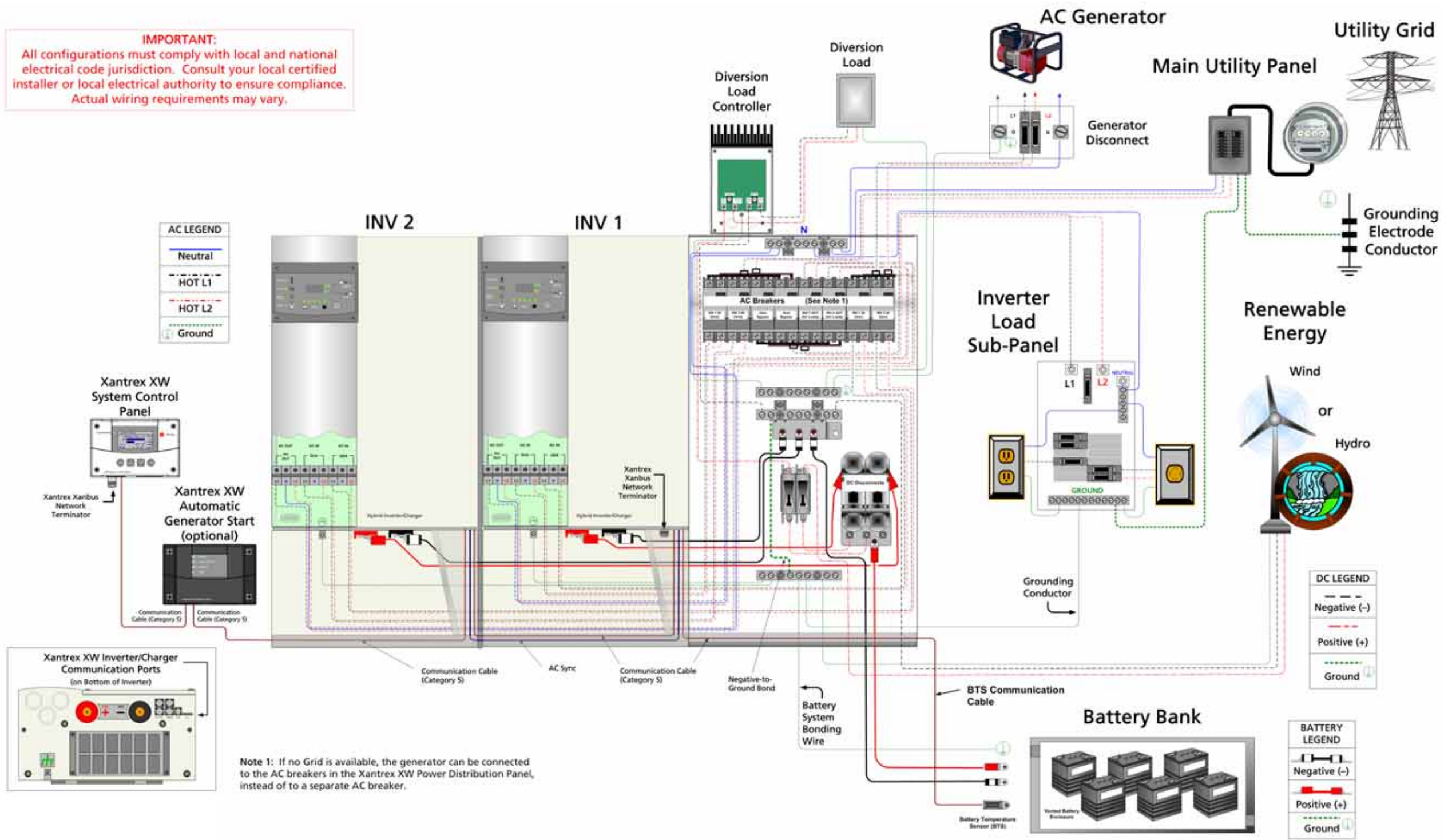

Figure B-6 Dual-Inverter System Renewable Energy (Wind or Hydro)

AC Wiring for a Four-Inverter System

Actual wiring requirements may vary.

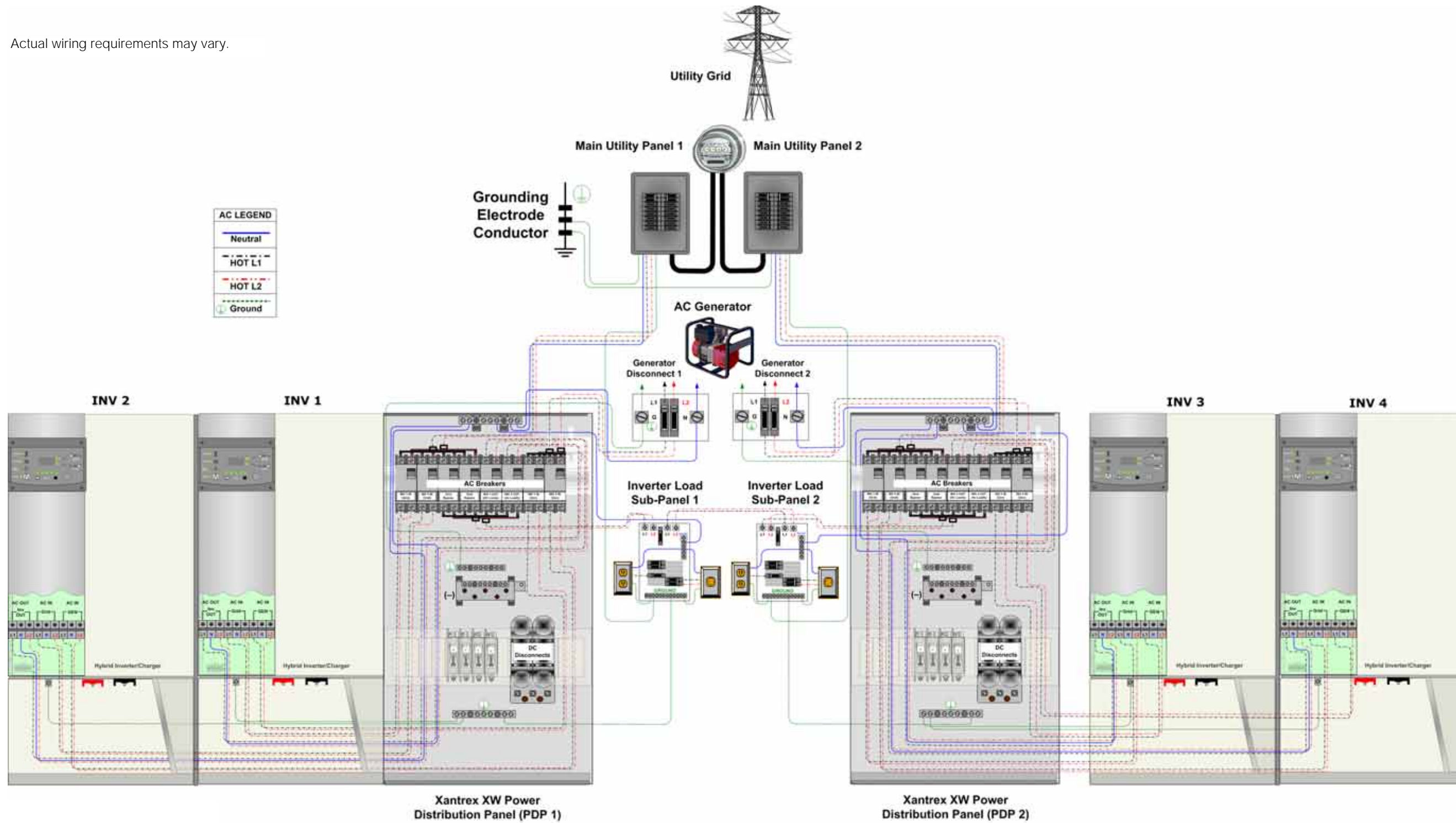

Figure B-7 AC Wiring for a Four-Inverter System

C

Alternate System Configurations

Appendix C, "Alternate System Configurations" provides wiring diagrams for inverter/charger installations that do not require use of the Xantrex XW Power Distribution Panel and the Xantrex XW Conduit Box.

DC Grounding for Single-Inverter Systems

See Table 2-4, "Torque Values for AC Wiring (AC Terminals and Ground Bar)," on page 12.

See Table 2-5, "Torque Values for the Chassis Ground Lug," on page 12.

See Table 2-6, "Torque Values for the Inverter Battery Terminals," on page 13.

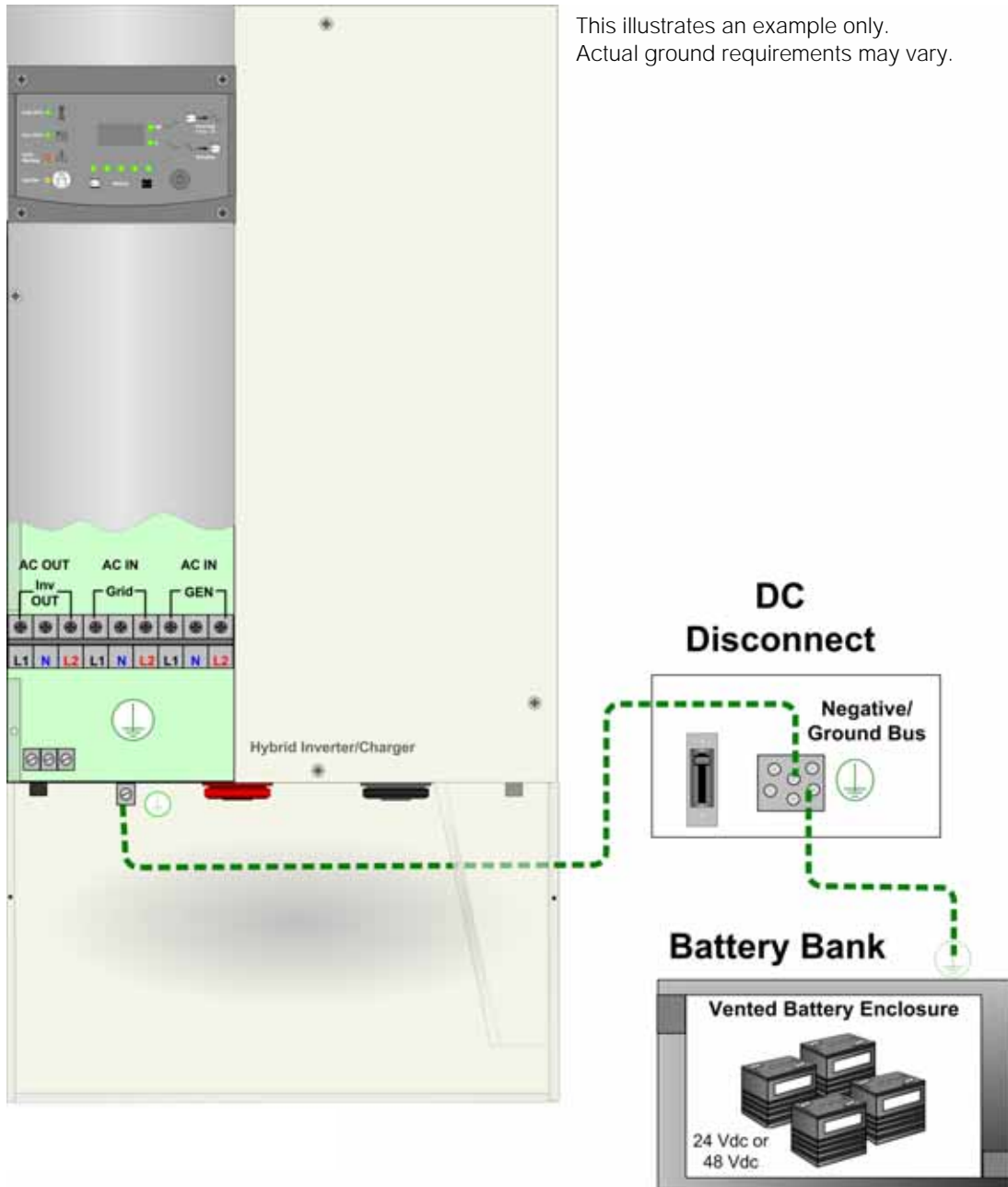
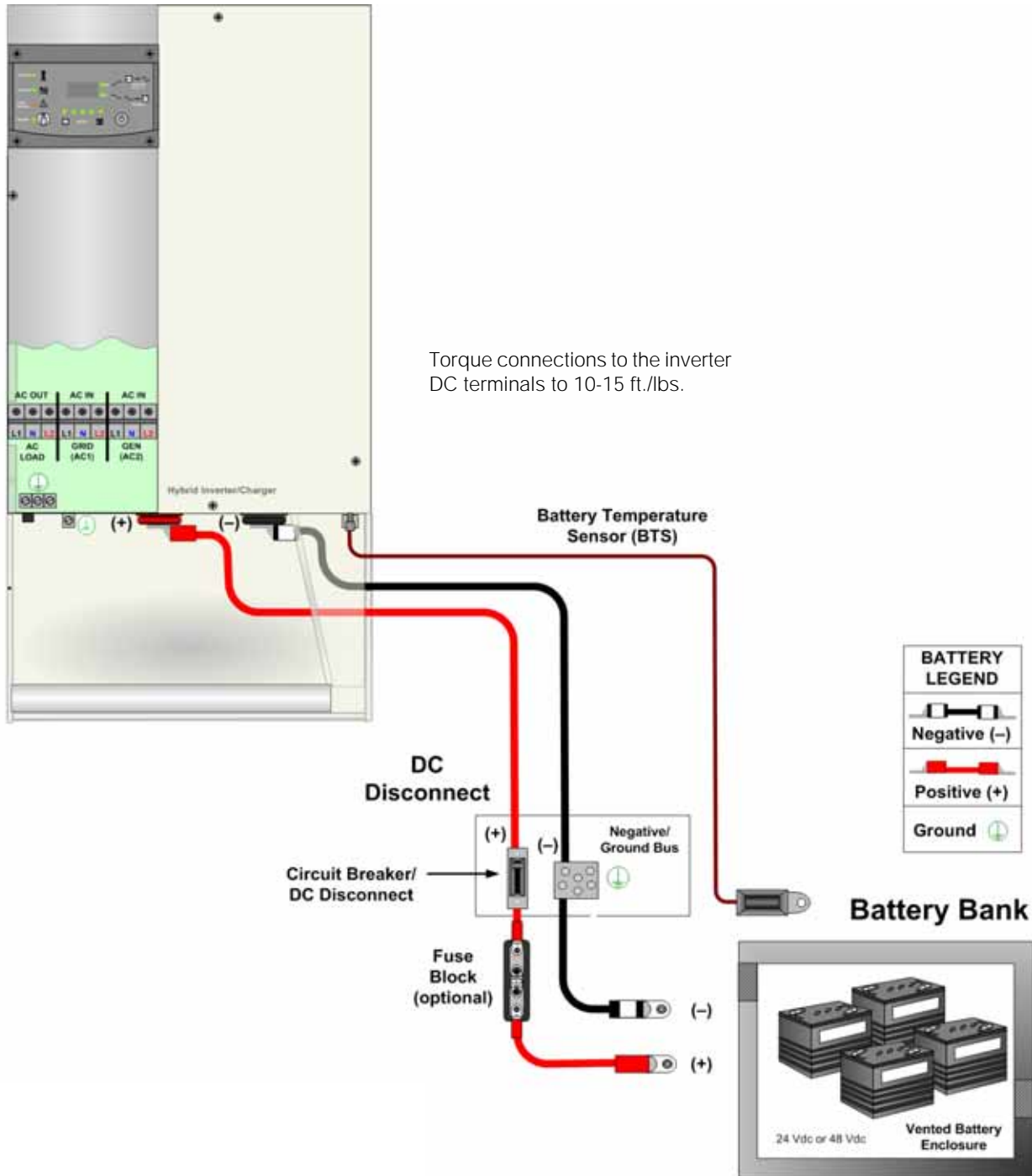

Figure C-1 DC Grounding for an Inverter Only

Battery Connections for Single Inverter Systems



This illustrates an example only. Actual cable requirements may vary.

Torque connections to the battery terminals per battery manufacturer's recommendations.

Figure C-2 DC Connections to a Single Inverter

AC Grounding for Single-Inverter Systems

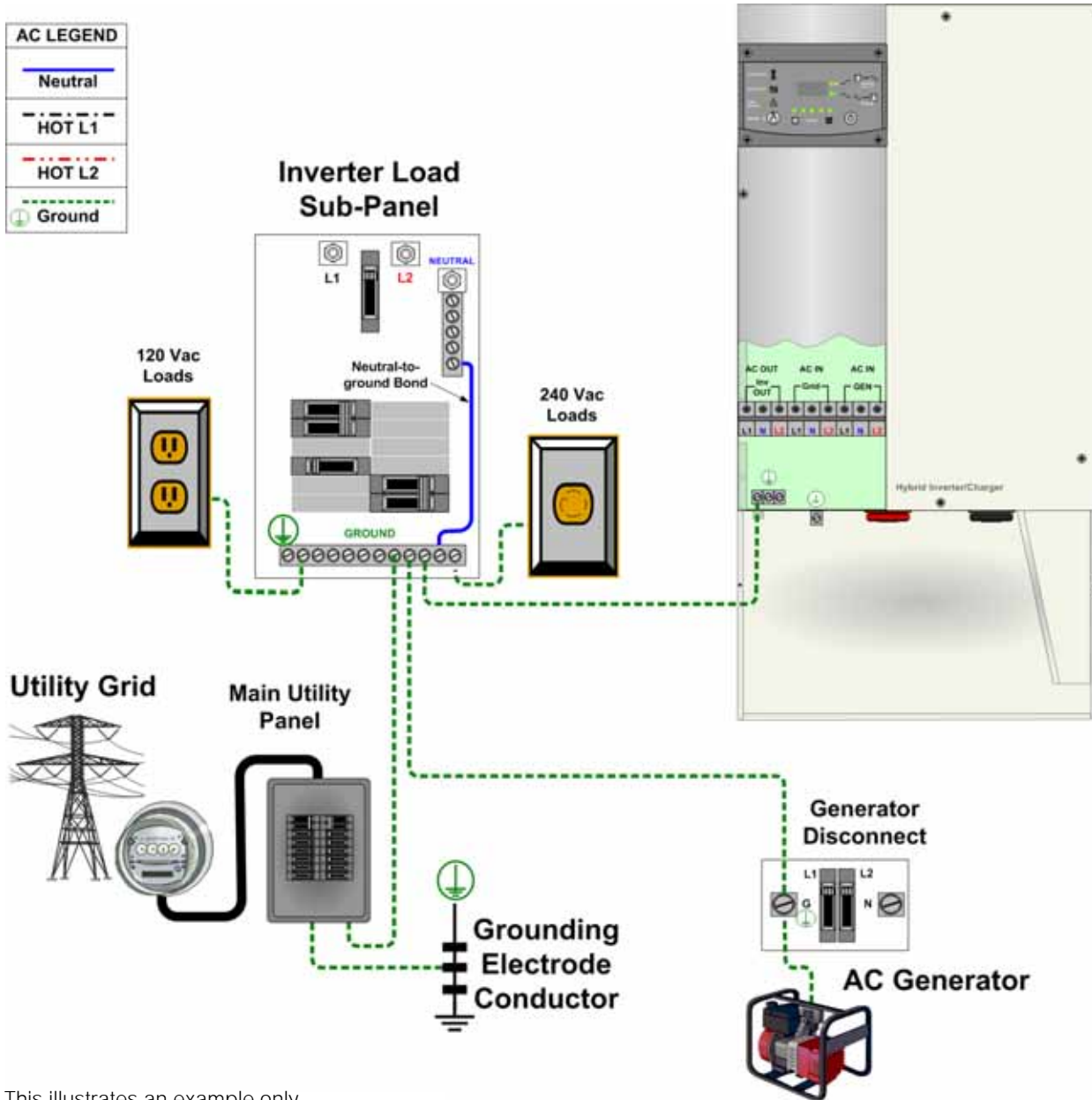

This illustrates an example only. Actual ground requirements may vary.

Figure C-3 Grounding the AC System

AC Output Wiring to the Inverter Load Sub-Panel

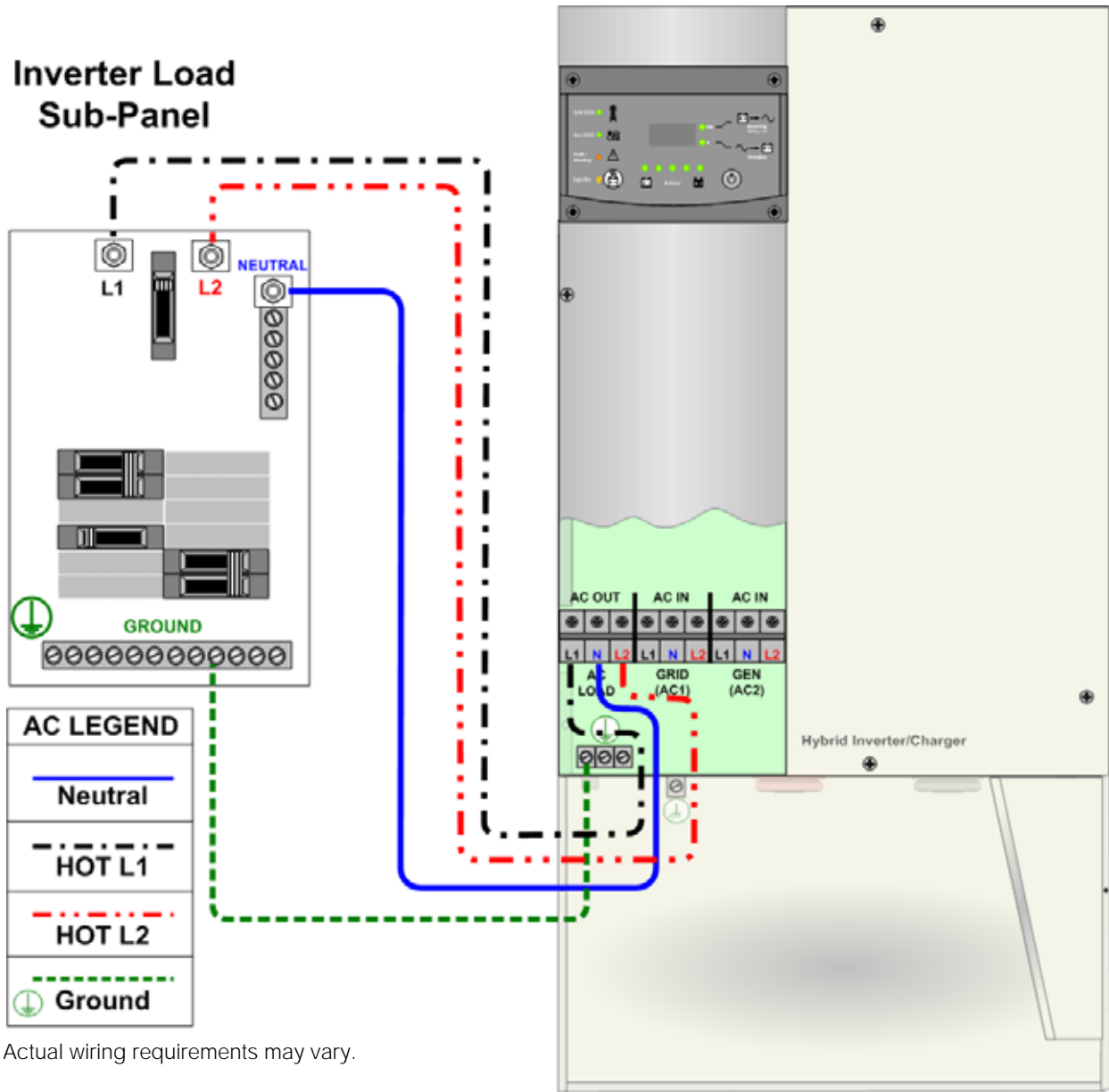

Figure C-4 AC Output Wiring to the Inverter Load Sub-Panel

Generator Wiring to the Inverter



WARNING: Shock Hazard

Before making any electrical connections, make sure all AC and DC disconnect devices are in the OPEN (disconnect) position.

Important: If the load is too big for the inverter to operate from battery power, do not install the load in the inverter powered electrical panel.

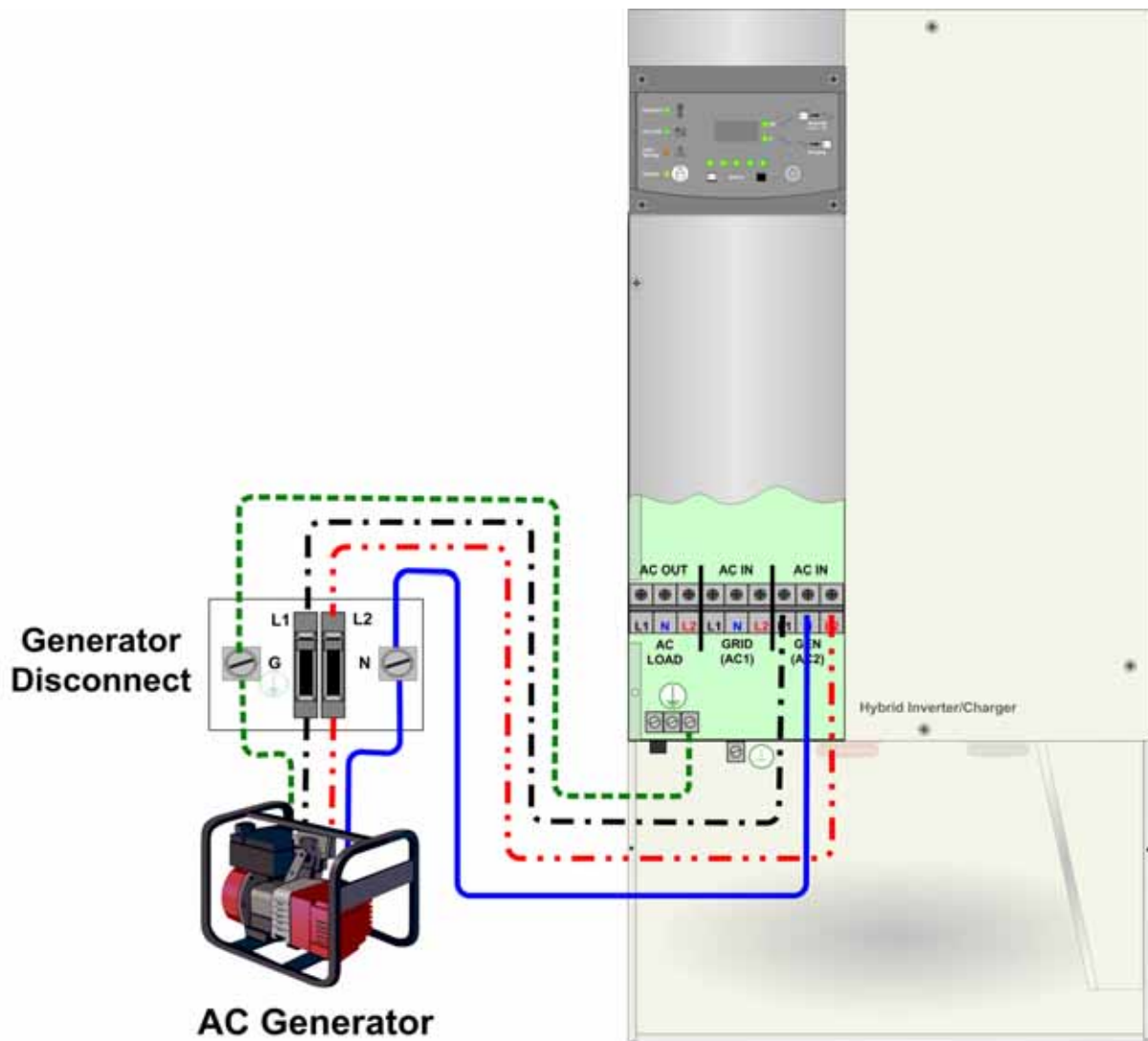

This illustrates an example only.
Actual wiring requirements may vary.

Torque all inverter terminal block connections to 25 inch-pounds.

Figure C-5 Generator Wiring directly to the Inverter

Utility Wiring to the Inverter Input

**CAUTION: Damage to Equipment**

The inverter's AC LOAD terminals must never be wired to any AC source such as a generator output or utility panel. This will cause severe damage to the inverter which is not covered under warranty.

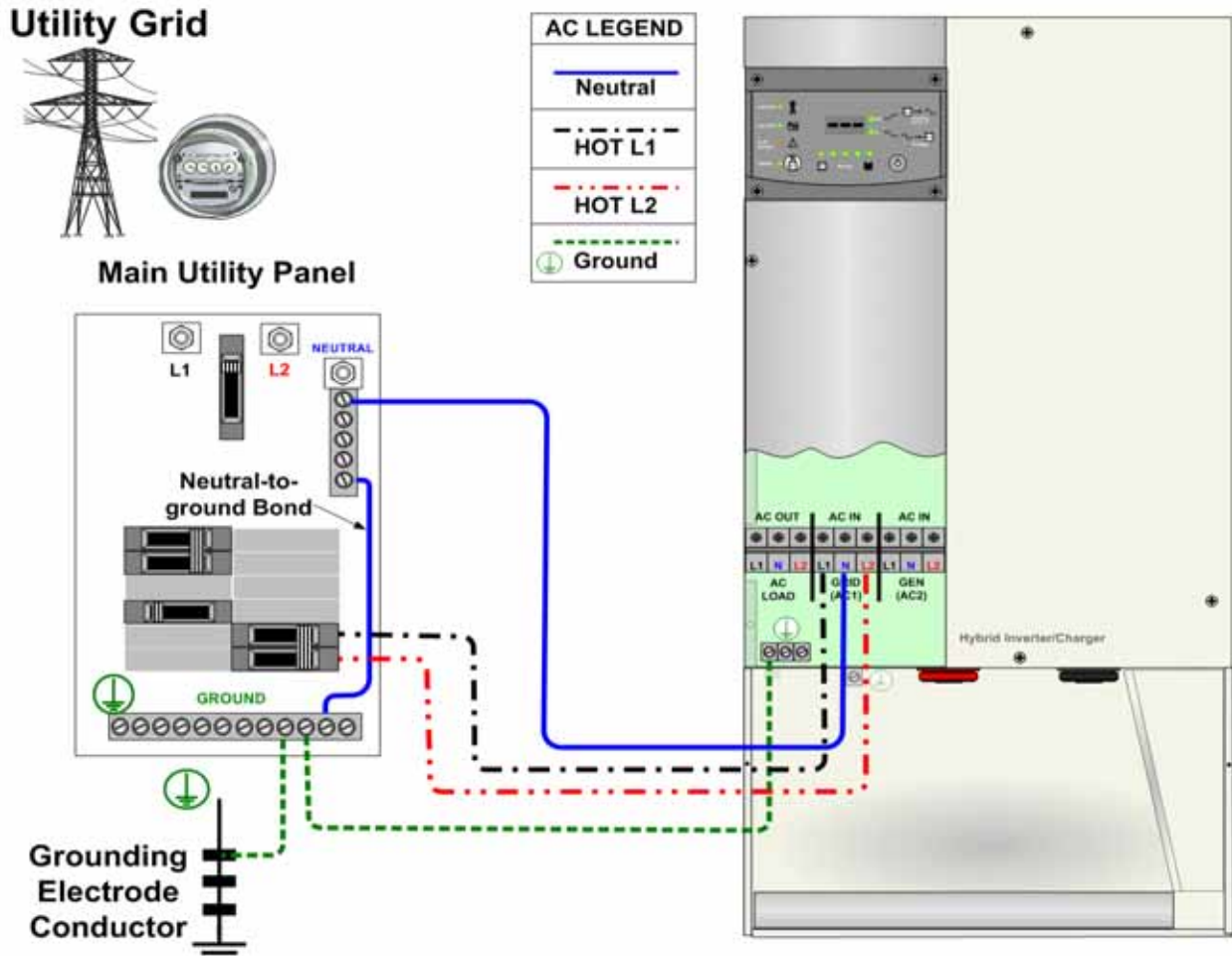

Actual wiring requirements may vary.

Figure C-6 Utility Wiring to the Inverter Input

D

Split-Phase to Single-Phase Conversion Instructions

Appendix D, "Split-Phase to Single-Phase Conversion Instructions" provides instructions for converting a Xantrex XW Inverter/Charger 120 V/240 V, split-phase model to a 120 V, single-phase model.

Converting from 120 V/240 V split-phase to 120 V single-phase is required in systems with single-phase (2-wire 120 V) or three-phase (208/120 V) sources (such as generators or grid). For a three-phase system, the loads may consist of single-phase loads or three-phase loads. Please refer to the wiring diagrams starting on page D-11. If you have questions, contact customer service at 1-800-670-0707 or RE.TechSupport@schneider-electric.com.

Important: To complete the conversion, you must refer to instructions in the *Xantrex XW Config User's Guide* (Document Part Number 975-0365-01-01). If you want to set up a single-phase system, you must refer to instructions in the *Xantrex XW Inverter/Charger Operation Guide* (Document Part Number 975-0240-01-01). If you do not have these guides, download them from www.schneider-electric.com.

For this Topic	See....
"Converting 120 V/240 V Split-Phase to 120 V Single-Phase"	page D-3
"Parts and Tools Required"	page D-3
"Disconnecting Power Sources"	page D-4
"Removing the Wiring Compartment Cover"	page D-4
"Reconfiguring the Secondary Transformer Wires on X1 and X2 Connectors"	page D-5
"Reconfiguring the AC Ports on the Load, AC1, and AC2 Connectors"	page D-7
"Upgrading the Firmware"	page D-8
"Updating the Label"	page D-9
"Xantrex XW 120 V Balanced Three-Phase System with Renewable Energy (Solar) – Customer-Supplied AC Breakers"	page D-11
"Xantrex XW 120 V Balanced Three-Phase System with Renewable Energy (Solar) – Manufacturer-Supplied AC Breakers"	page D-12
"Xantrex XW 120 V Single-Phase System with Renewable Energy (Solar) – Manufacturer-Supplied AC Breakers"	page D-13

Converting 1 20 V/240 V Split-Phase to 1 20 V Single-Phase

The following sections provide instructions on how to reconfigure a standard Xantrex XW 120 V/240 V, 3-wire, split-phase model to accept a 120 V, 2-wire, single-phase connection. To set up a three-phase system using three 120 V-configured Xantrex XW units, perform these steps for all three inverter/chargers.



WARNING: Shock and Fire Hazard

Disconnect all AC and DC sources from the inverter/charger before removing the covers. Failure to do so may result in damage to the inverter/charger or personal injury.

Parts and Tools Required

To complete the conversion, you will need one small jumper and three large jumpers as shown in Figure D-1. These jumpers are included in the packaging bag shipped with each Xantrex XW Inverter/Charger.

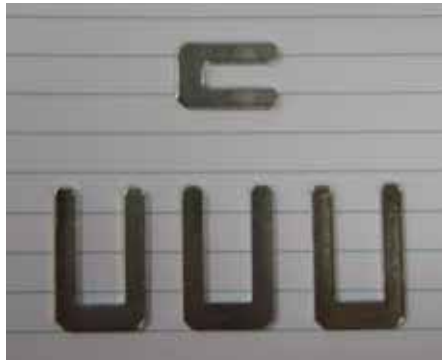

Figure D-1 Jumpers

You will need a Phillips #2 screwdriver and may require other tools, as necessary.

Disconnecting Power Sources

To disconnect power sources:

1. Put the Xantrex XW system in Standby mode using the System Settings menu on the Xantrex XW System Control Panel, disconnect AC sources (such as the utility grid and generators) by turning off the AC input breakers, and disconnect DC sources (for example, batteries) by turning off the DC breaker.
2. Turn off and disconnect all AC loads by turning off the AC output breaker.

Important: It is not necessary to remove the unit from its mounting position to perform the following tasks.

Removing the Wiring Compartment Cover

To remove the wiring compartment cover:

1. Remove Screw A and B shown in Figure D-2.
2. Remove the wiring compartment cover (see Figure D-3 on page D-5).

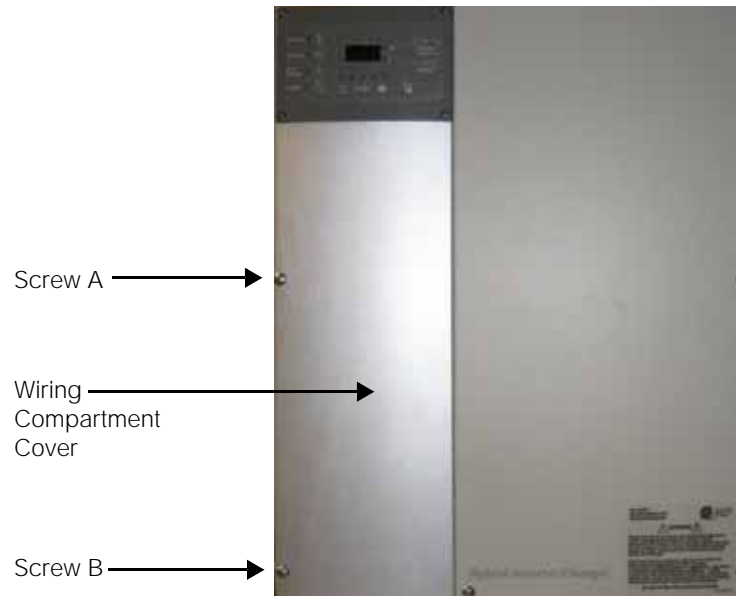

Figure D-2 Xantrex XW Inverter/Charger Front View

Reconfiguring the Secondary Transformer Wires on X1 and X2 Connectors

To reconfigure the secondary transformer wires on the X1 and X2 connectors:

1. Locate the X1 and X2 connectors (see Figure D-3).

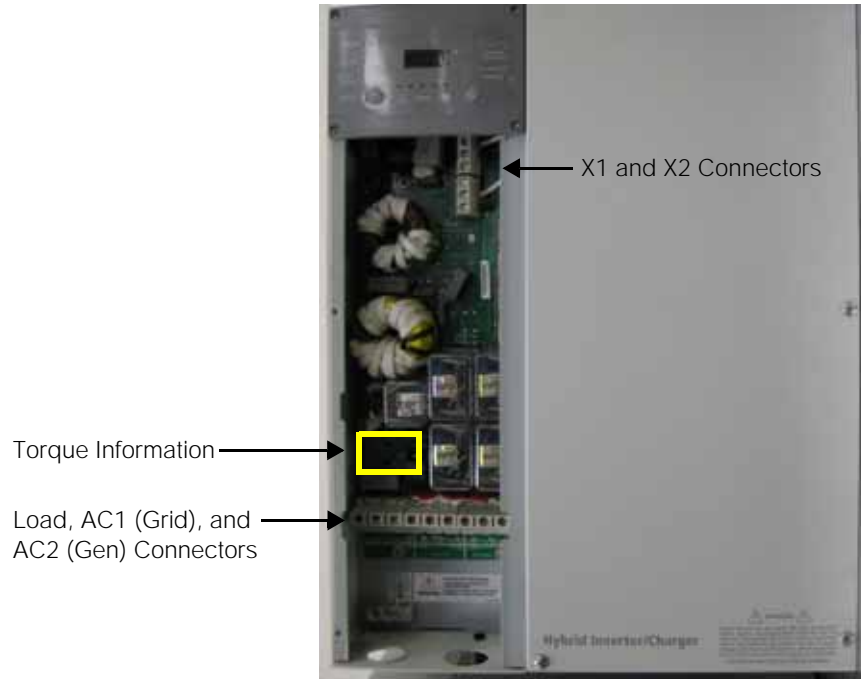

Figure D-3 Connector Locations.

2. Remove the secondary transformer wire X2 (black) from slot X2-A, and then insert it into slot X2-B (see Figure D-4 and Figure D-5).
3. Remove the secondary transformer wire X3 (white) from slot X3-A, and then insert it into slot X3-B (see Figure D-4 and Figure D-5).
4. Insert one small jumper between slot X2-A and X2-B (see Figure D-4 and Figure D-5). The jumper must be on top of the wire.
5. Tighten all terminals to 35 in-lb per the torque information printed on the AC board. See Figure D-3 for the torque information location.
6. Make sure the new connections are correct by comparing them to the **after** photograph displayed on the right in Figure D-5.

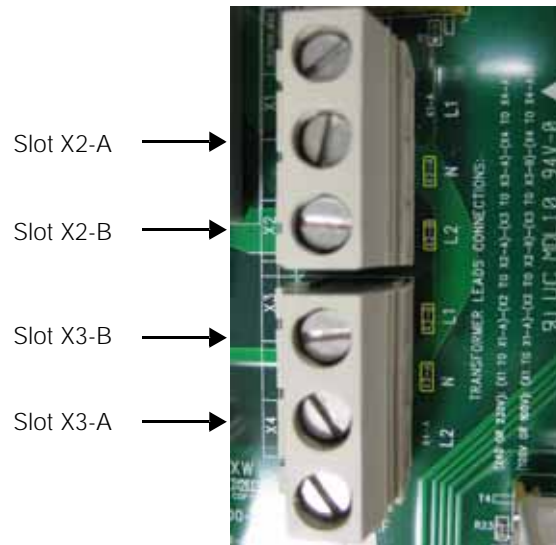
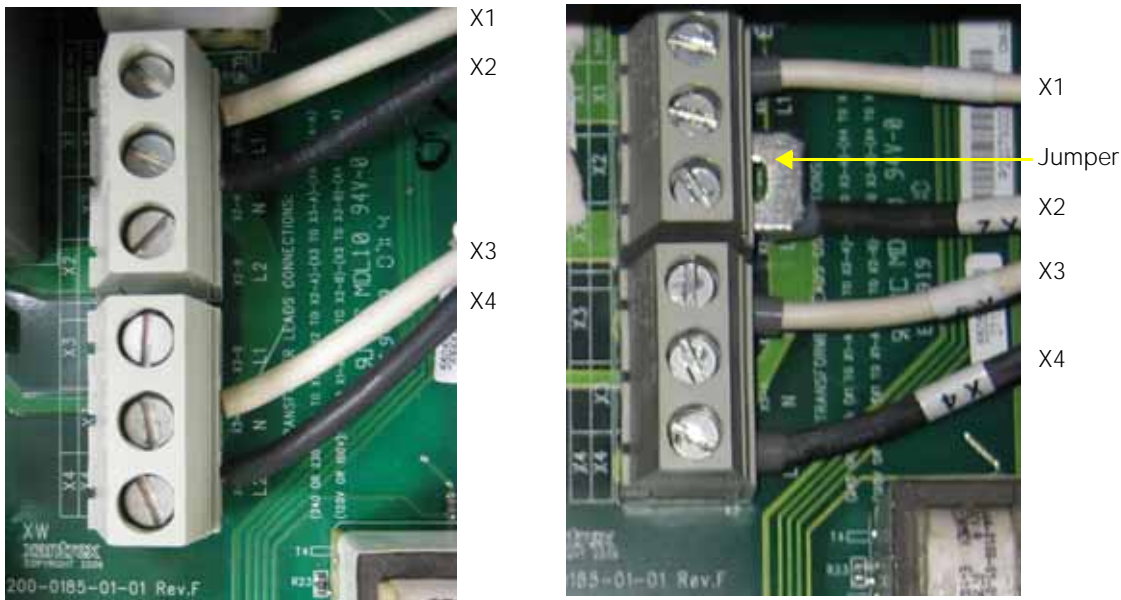

Figure D-4 Slot Locations on X1 and X2 Connectors



Secondary transformer wire X1, X2, X3, and X4 locations BEFORE reconfiguration

Secondary transformer wire X1, X2, X3, and X4 locations AFTER reconfiguration

Figure D-5 X1 and X2 Connectors Before and After Reconfiguration

Reconfiguring the AC Ports on the Load, AC1, and AC2 Connectors

To reconfigure the AC ports on the Load, AC1 (Grid), and AC2 (Gen) connectors:

1. Locate the Load, AC1 (Grid), and AC2 (Gen) connectors (see Figure D-3 on page D-5).
2. Insert one large jumper in each connector to short out N and L2, as shown in Figure D-6.

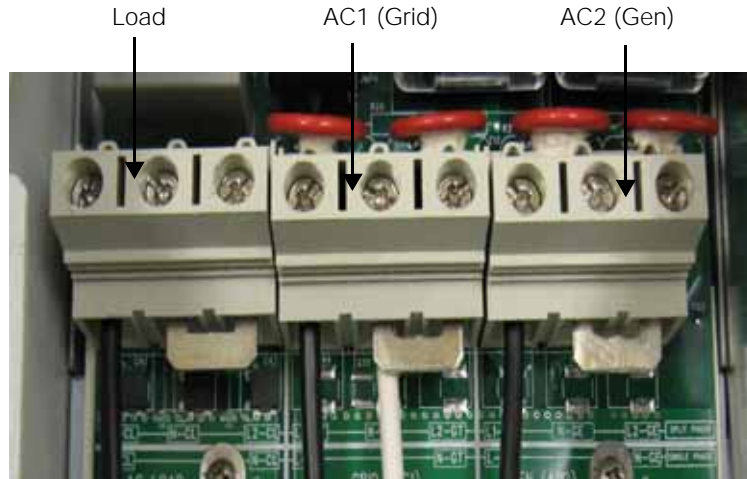

Figure D-6 Jumper Locations and AC Cable Configuration on AC Ports

3. Connect the AC cables as shown in Figure D-6. The jumper must be on top of the wire.
4. Tighten all terminals per the torque information printed on the AC board. See Figure D-3 on page D-5 for the torque information location.
5. Reconnect the DC sources (for example, batteries) by turning on the DC breaker.

Upgrading the Firmware

To upgrade the firmware, you must refer to instructions in the *Xantrex XW Config User's Guide* (Document Part Number 975-0365-01-01). If you do not have this guide, download it from www.schneider-electric.com.

To upgrade the firmware:

1. Acquire the USB-to-Xantrex Xanbus adapter to connect the Xantrex XW System to a PC (Product Part Number 865-1155).
2. Download the USB-to-Xantrex Xanbus adapter driver (available on www.schneider-electric.com).
3. Connect the USB-to-Xantrex Xanbus adapter to a USB port on your computer, and then install the downloaded driver. See the *Xantrex XW Config User's Guide* for detailed instructions.
4. Download and save the latest Xantrex XW 6048-120 V firmware onto your computer (available on the Xantrex XW product page at www.schneider-electric.com).
5. Make sure nominal DC voltage is present at the unit's DC terminals.
6. Download and install the latest Xantrex XWConfig to your computer (available on the Xantrex XW product page at www.schneider-electric.com).
7. Run Xantrex XWConfig.
8. Select **Convert** from the Xantrex XWConfig menu (see Figure D-7), and then follow the on-screen instruction to complete the conversion.

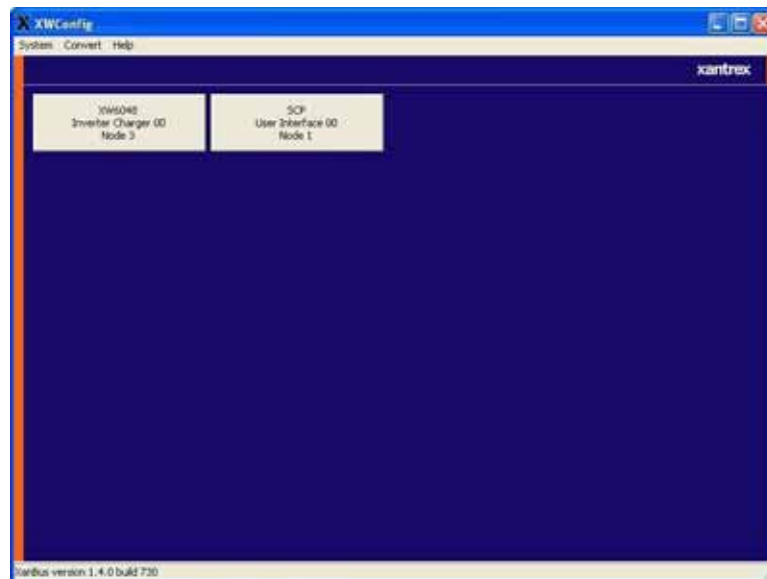

Figure D-7 Xantrex XWConfig

9. For future reference, record the new firmware version.

Updating the Label

On the inverter/charger, mark the box on the bottom of the label beside "OPTIONAL CONFIGURATION, 120 v, 2 WIRE" to indicate the inverter has been converted. See Figure D-8.

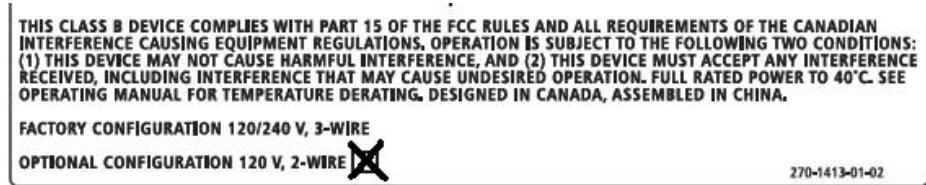

Figure D-8 Updated Label

The conversion of one Xantrex XW 120 V/240 V, split-phase model to a 120 V, single-phase model is now complete.

- To set up a single-phase system, repeat the steps in "Converting 120 V/ 240 V Split-Phase to 120 V Single-Phase" starting on page D-3 for up to three more inverter/chargers, and then refer to the *Xantrex XW Inverter/Charger Operation Guide* (Document Part Number 975-0240-01-01) and follow the instructions under "Setting Up a Single-Phase System."
- To set up a three-phase system using three Xantrex XW 120 V, single-phase models, repeat the steps in "Converting 120 V/240 V Split-Phase to 120 V Single-Phase" starting on page D-3 for two more inverter/chargers, and then refer to the *Xantrex XW Inverter/Charger Operation Guide* (Document Part Number 975-0240-01-01) and follow the instructions under "Setting Up a Three-Phase System."

Xantrex XW 120 V Balanced Three-Phase System with Renewable Energy (Solar) – Customer-Supplied AC Breakers

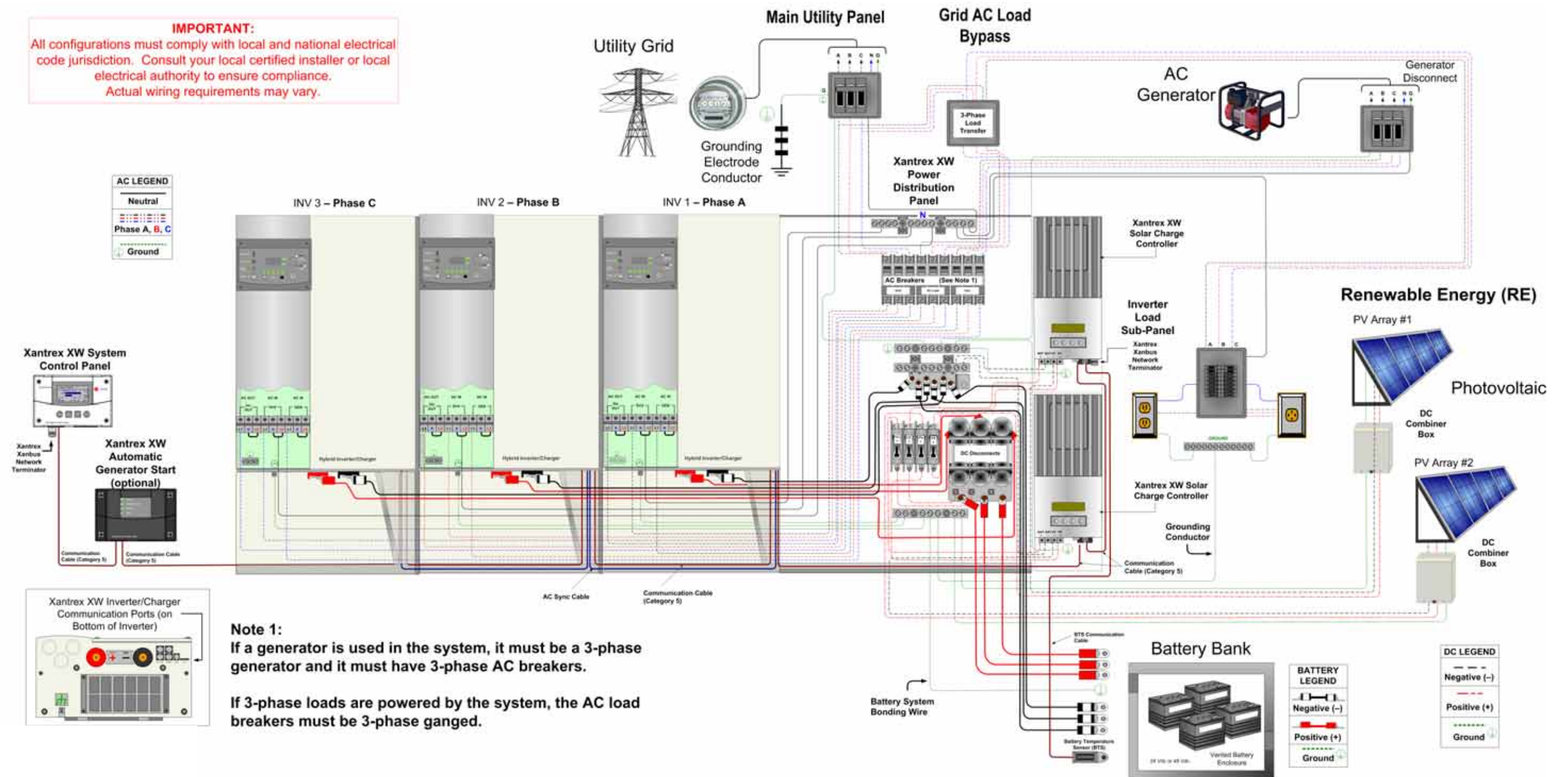

Figure D-1 Xantrex XW 120 V Balanced Three-Phase System with Renewable Energy (Solar) – Customer-Supplied Breakers

Xantrex XW 120 V Balanced Three-Phase System with Renewable Energy (Solar) – Manufacturer-Supplied AC Breakers

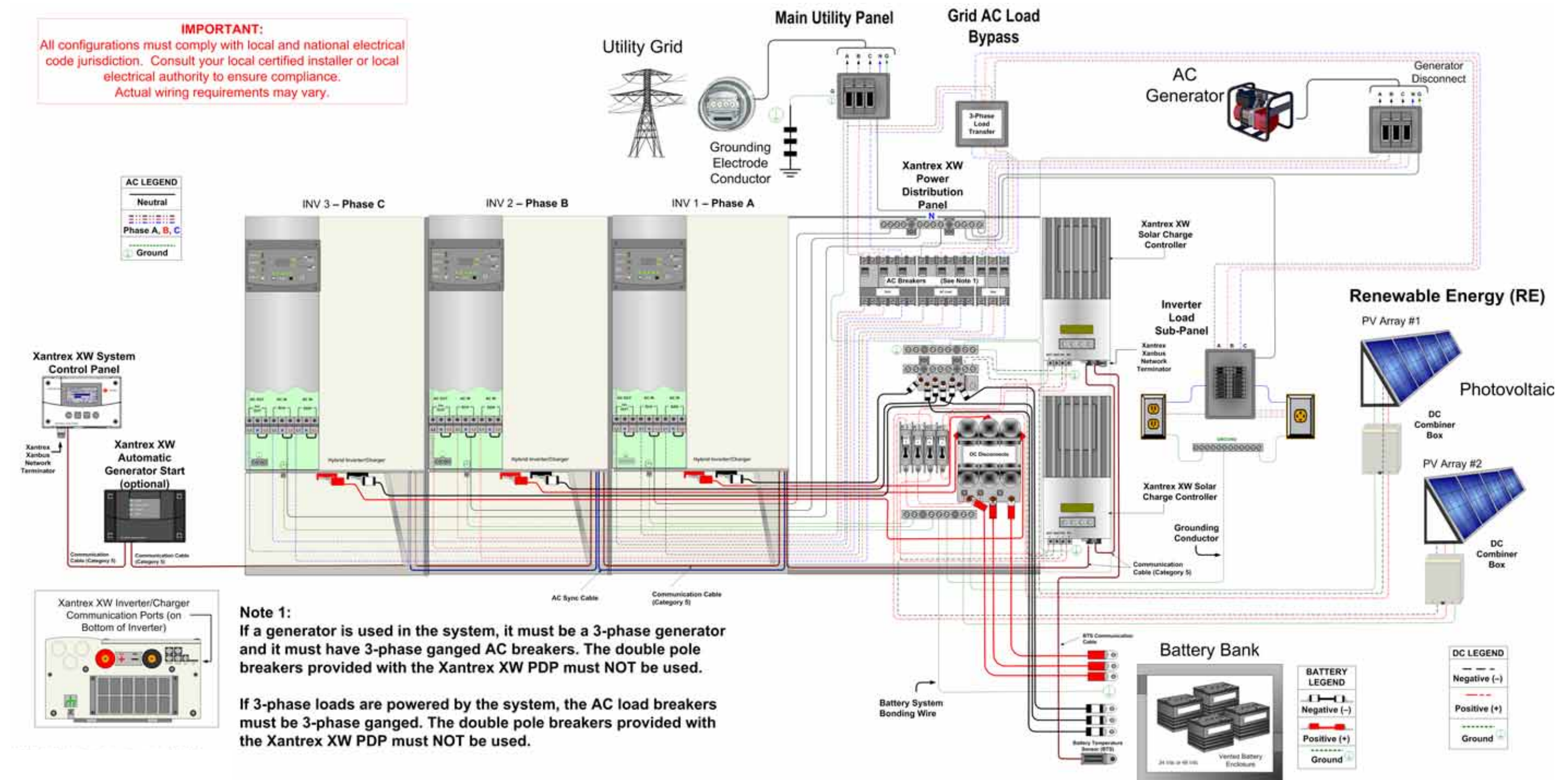

Figure D-2 Xantrex XW 120 V Balanced Three-Phase System with Renewable Energy (Solar) – Manufacturer-Supplied Breakers

Xantrex XW 120 V Single-Phase System with Renewable Energy (Solar) – Manufacturer-Supplied AC Breakers

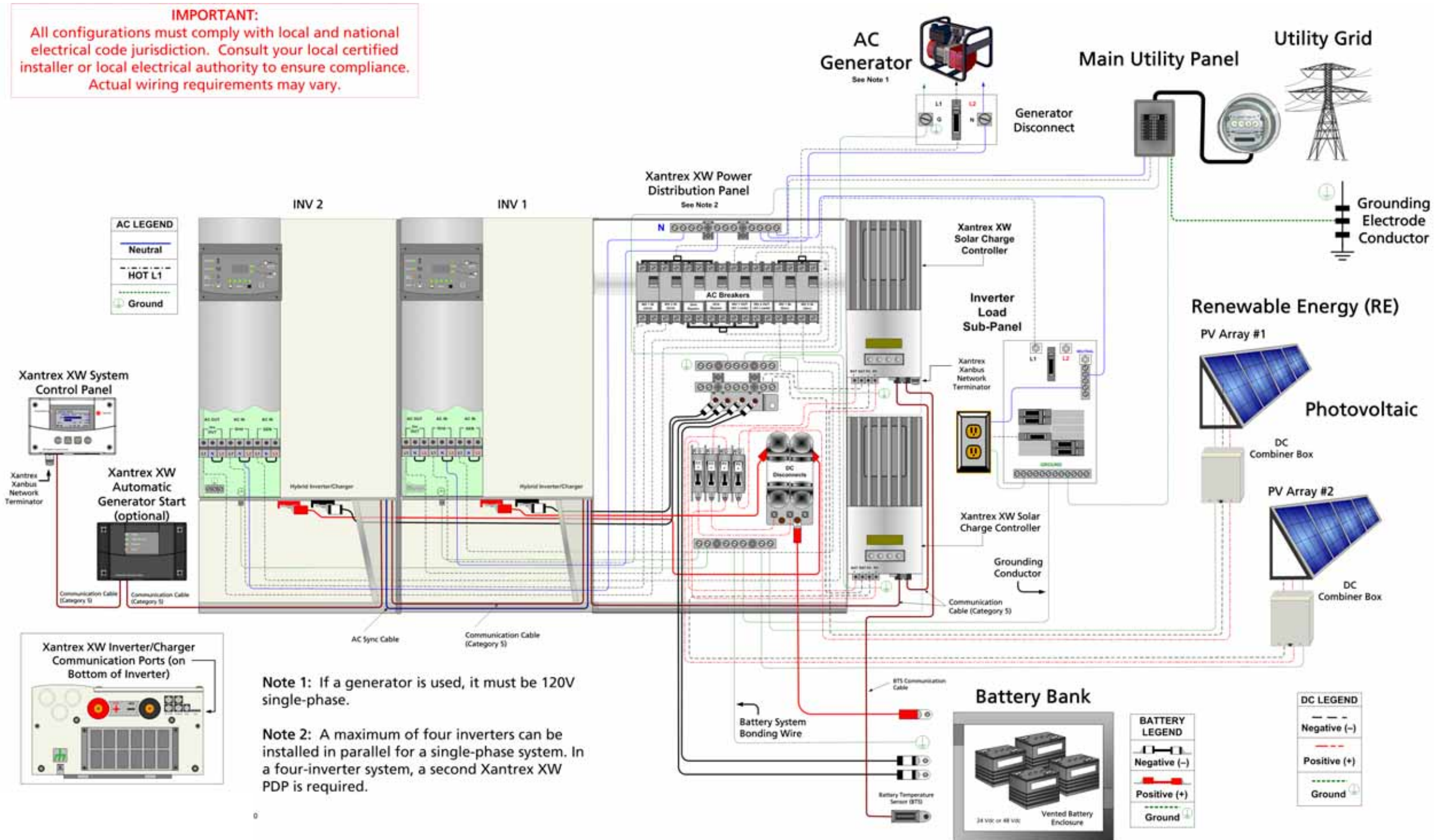

Figure D-3 Xantrex XW 120 V Single-Phase System with Renewable Energy (Solar) – Manufacturer-Supplied AC Breakers

A

abbreviations and acronyms v
AC Connections 2-19
AC sync cable 2-52
AC Terminal Block 2-21
Additional Inverters 2-38
Automatic Generator Start 1-8, 5-7
AUX Port 2-30
AUX Port Terminal Assignments 2-31
AUX+12V Voltage Supply 2-31
AUX-RPO
 User Remote Power Off 2-31

B

B+ wires 5-13
battery bank requirements 2-10
battery cable lugs 2-11
Battery Cable Requirements 2-11
Battery Cable Size 2-12
Battery Temperature Sensor 2-15
Breaker/Fuse Size 2-12

C

charge controller 1-7
Clearance 2-4
commissioning 4-19
Communication Ports 2-20
Conduit Box 1-4, 2-8
current rating 4-13

D

DC Connections 2-17
Dual-Inverter System Renewable Energy (Solar) B-7
Dual-Inverter System Renewable Energy (Wind or Hydro) B-8

E

external LED wire 5-13, 5-16
external on/off LED 5-17
external shutdown switch
 connecting to wiring harness 5-15
 input and return 5-13, 5-15

F

FCC information to the user 1-viii
Fire safety 2-2
functional test 2-32, 2-53

G

generator run signal 5-13
Generator Wiring 2-28
Ground Bar 2-21
Grounding 2-14, 4-9
Grounding the DC System 2-14

I

installation
 mounting 5-4, 5-6
 planning 5-3
Inverter Panel Mounting 2-23

K

Knockout 2-3
Knockouts 4-5

L

LED Status Indicators
 Inverting 2-34
Location 2-2
lugs, battery cable 2-11

M

Mechanical Specifications A-9, A-10
Mounting 2-4
Mounting Bracket 2-5
mounting template 5-6
Mounting the Distribution Panel 2-8
Mounting the Inverter 2-7

O

overcurrent protection, requirements 2-11

S

safety instructions 1-vii-??
Schneider Electric
 web site v
Single-Inverter System B-3, B-4, D-11
Single-Inverter System Renewable Energy (Wind or Hydro) B-6
Single-Inverter System Renewable Energy (Solar) B-5
switched B+ wires 5-13

T

thermostat
 connecting 5-15
 inputs and returns 5-13, 5-15

U

User Line Wiring 2-31

V

verifying network power 5-7, 5-20

W

web site 1-v

wire size 4-12

Wire Size and Overcurrent Protection
Requirements 4-12

Wiring 4-12

Wiring the Inverter 2-9

X





Xantrex XW Inverter/Charger 1-3

Xantrex XW Solar Charge Controller 4-2

Xantrex XW System Control Panel 1-8, 5-2

Schneider Electric

www.schneider-electric.com

			
North America	1 650 351 8237 1 866 519 1470	1 925 245 1022	re.techsupport@schneider-electric.com
France	0 825 012 999		fr-re-techsupport@fr.schneider-electric.com
Deutschland	+49 (0) 180 575 3 575	+49 (0) 2102 404 7101	pv-service@de.schneider-electric.com
España	+34 902 101 813	+34 933 055 026	es-sat@es.schneider-electric.com
L'Italia	+39 035 4151111	+39 035415 3200	IT-pronto-contatto@it.schneider-electric.com

For other country details please contact your local Schneider Electric Sales Representative or visit our website at: <http://www.schneider-electric.com/sites/corporate/en/support/operations/local-operations/local-operations.page>