

Pre-RMA Bench Test Instructions

Table of Contents

| | |
|--|-----------|
| 1. Introduction | 1 |
| 1.1. Safety | 1 |
| 1.2. Testing equipment, test bench and tools | 1 |
| 1.2.1. Tools | 2 |
| 1.2.2. DC source | 3 |
| 1.2.3. DC loads | 4 |
| 1.2.4. AC source | 4 |
| 1.2.5. AC loads | 5 |
| 1.2.6. Cables and interfaces | 5 |
| 1.2.7. Measurement equipment and software | 6 |
| | |
| 2. Pre-RMA test form - Inverter | 7 |
| | |
| 3. Pre-RMA test form - SUN Inverter | 11 |
| | |
| 4. Pre-RMA test form - Inverter/charger | 15 |
| | |
| 5. Pre-RMA test form - Smart charger | 20 |
| | |
| 6. Pre-RMA test form - MPPT solar charger | 24 |
| | |
| 7. Pre-RMA test form - BMV battery monitors | 29 |
| | |
| 8. Pre-RMA test form - BatteryProtect | 33 |
| | |
| 9. Pre-RMA test form - Orion-Tr DC-DC converter | 36 |
| | |
| 10. Pre-RMA test form - Lead-acid battery | 40 |
| | |
| 11. Pre-RMA test form - Lithium Battery Smart | 44 |

1. Introduction

This document is primarily intended for Victron distributors. It is shared publicly for the benefit of professional installers and others who are comfortable with, and are able to, safely carry out the described tests themselves.

In case you are not, this is not a problem. It is not at all required to perform these tests yourself before sending a product to a dealer or distributor for checking or repair.

Before submitting a warranty claim, repair request or replacement request (RMA), Victron Energy requires that the unit in question is bench tested by our direct customer (the Victron Energy distributor). This is to prevent an RMA from being submitted for non-faulty units or units with non-warrantable faults.

This document describes the setup and equipment needed to perform a successful bench test and contains testing instructions for most Victron Energy product groups, which need to be completed before an RMA is submitted.

The tests described in this document cover all basic functionality. Some lesser-used or simpler-to-test product features are not included. For example, programmable relays, communication ports, remote on/off terminals and so forth. Should these be reported by your customer as faulty, then, of course, bench test for that.

1.1. Safety

The cover of our products may only be removed by a qualified technician with electronic or electromechanical training who is aware of the local safety guidelines and requirements.



Before testing a Victron Energy product, always refer to the safety instructions listed in its product manual. Product manuals are available from the product pages on the [Victron Energy website](#).

Some basic safety guidelines:

- AC voltage is dangerous and harmful. Use fused circuit breakers and RCDs.
- DC voltage is dangerous and harmful.
- Do not short circuit batteries.
- When working with batteries, make sure all DC loads are sufficiently fused.
- Be aware that lead-acid battery charging can create explosive gasses.
- Always use electrically insulated tools.

1.2. Testing equipment, test bench and tools

To be able to confirm if a Victron Energy product is faulty, it needs to be individually tested. These tests are performed on a dedicated test bench. The test bench contains all equipment needed for the test.

Ideally, this test bench is permanently set up in your workshop and readily accessible.

The test bench is one of your own design. It contains all relevant equipment that is needed for testing a Victron Energy product.

A test bench generally contains the following items:

- Battery bank and DC power supply.
- DC loads and AC loads.
- DC and AC circuit breakers and automatic fuses.
- DC and AC electrical cables with a variety of core thicknesses.
- Tools.
- Electrical measuring equipment.
- Computer and a tablet or smartphone.
- Interfaces and data cables.
- A peak current limiting resistor is needed to test the SUN Inverter's PV input. Two resistors of 1 Ohm, 200 Watt, are used in parallel for the 12/250 Sun inverter and in series for the 24/250 Sun inverter. Ensure that these resistors are rated in "free air" or alternatively mount them on an appropriate heatsink.

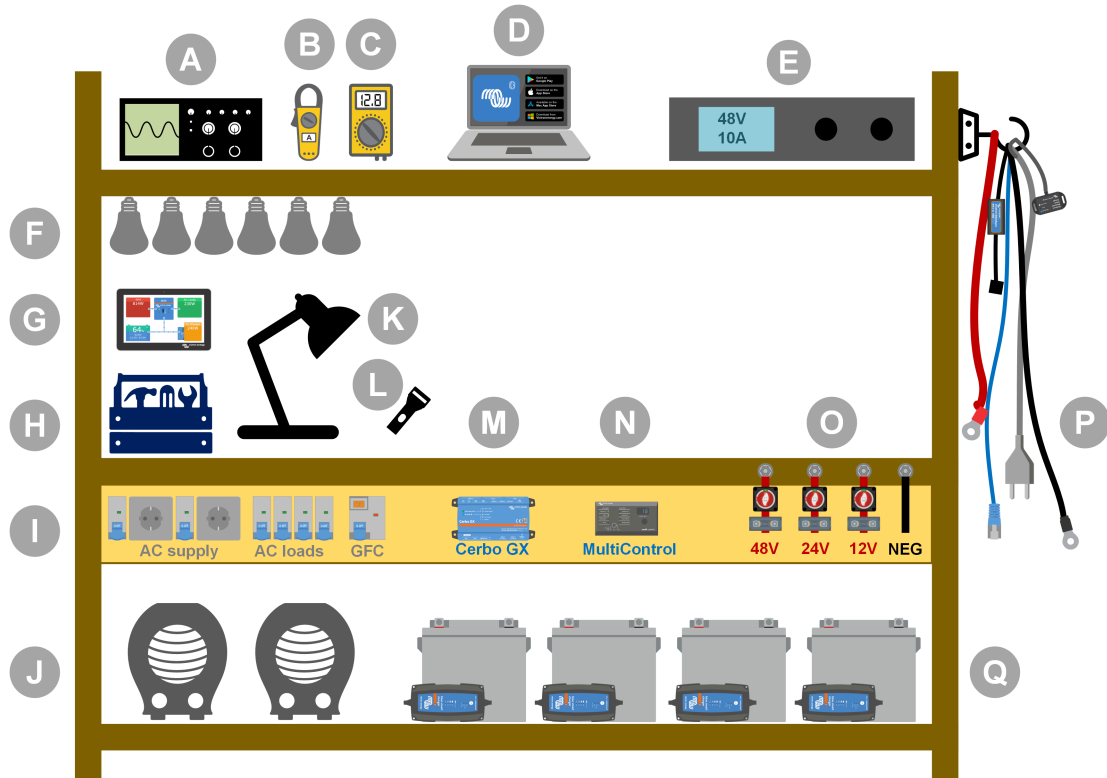

Example of a test bench.

| ID | Description |
|----|--|
| A | Oscilloscope (optional) |
| B | Current clamp |
| C | Multimeter |
| D | Computer and a tablet or smartphone |
| E | Power supply |
| F | AC and/or DC incandescent light globes |
| G | Touch GX |
| H | Tools |
| I | AC distribution board |
| J | AC heaters |
| K | Lamp |
| L | Torch |
| M | Cerbo GX |
| N | Digital Multi control panel |
| O | DC distribution board |
| P | Cables and interfaces |
| Q | Battery bank |

1.2.1. Tools

Always use insulated tools:

Working with electricity and batteries is dangerous. Avoid shorting battery terminals or the DC terminals inside our products. Use insulated nut drivers or spanners to prevent accidental short circuits.



Wiha insulated tool set with screwdrivers, nut drivers, pliers, cutters and so on.

Use appropriately sized tools and tighten correctly:

Almost all nuts, screws and bolts used in Victron Energy units are metric. Please use the appropriately sized tools.

Most connection bolts and screws are made of brass, as such, avoid over-tightening. A brass bolt or screw can easily snap. Use a torque spanner to prevent this. The appropriate torque settings are listed in the product manual.

If the torque moment is unknown, use this as a guide:

- M4 bolts, screws and nuts = 1Nm.
- M5 bolts, screws and nuts = 3Nm.
- M6 bolts, screws and nuts = 5.5Nm.
- M8 bolts, screws and nuts = 12Nm.

Avoid over-tightening cabinet screws. You can use automatic screwdrivers but check that you use a middle torque setting.

Crimping tools:

Ensure that the electrical cables have terminals suitable for the electrical connections that need to be made.

Use the correct crimping tool when crimping cable terminals onto cables.

1.2.2. DC source

A DC power supply or a set of batteries able to supply 12V, 24V or 48V.

DC Power supply:

Use a regulated DC power supply that is adjustable between 0-60V and 0-40A, like the DeltaElektronika SM3300 series. A power supply is the preferred option because it is capable of current limiting, thus eliminating the need for DC fusing.

Batteries:

If a power supply is not available, use batteries instead. Use four 12V batteries to create a 12V, 24V or 48V battery bank. But be aware that a battery short circuit should be prevented at all times, so DC fuses need to be used as well. For ease of use, use automatic fuses.

Multiple voltage battery bank:

Please refer to the image below for an example of a battery bank capable of supplying multiple voltages. To maintain balanced and charged batteries, connect a [BlueSmartIP65 charger](#) to each individual battery.

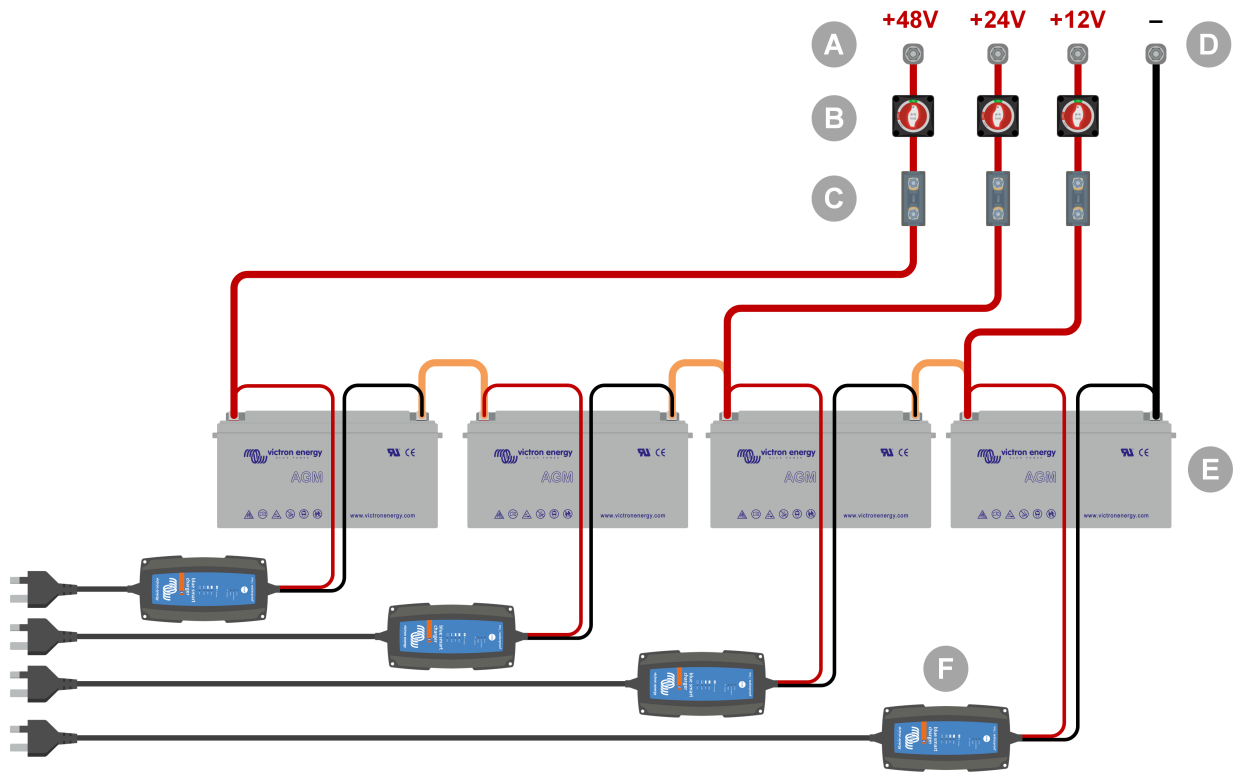

Example of a multiple voltage battery bank.

| ID | Description |
|----|---|
| A | 12V, 24V and 48V battery connections |
| B | Battery isolator switches |
| C | Fuses and fuse holders or automatic fuses |
| D | Negative battery connection |
| E | Batteries |
| F | BlueSmart IP65 battery chargers |

1.2.3. DC loads

Some examples of DC loads:

- A DC load bank.
- An inverter is running an AC load.
- DC incandescent light globes.

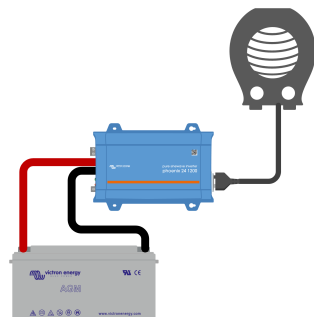

An Inverter used as a DC load

1.2.4. AC source

Use the grid (mains) as an AC source. Do not use a generator, as they often have an inferior sine wave.

To obtain another AC voltage, you can use a variable transformer (Variac) or a [Victron isolation transformer](#) to convert the grid voltage to the required voltage. This allows you to test 110Vac equipment in a 230Vac country or vice versa.

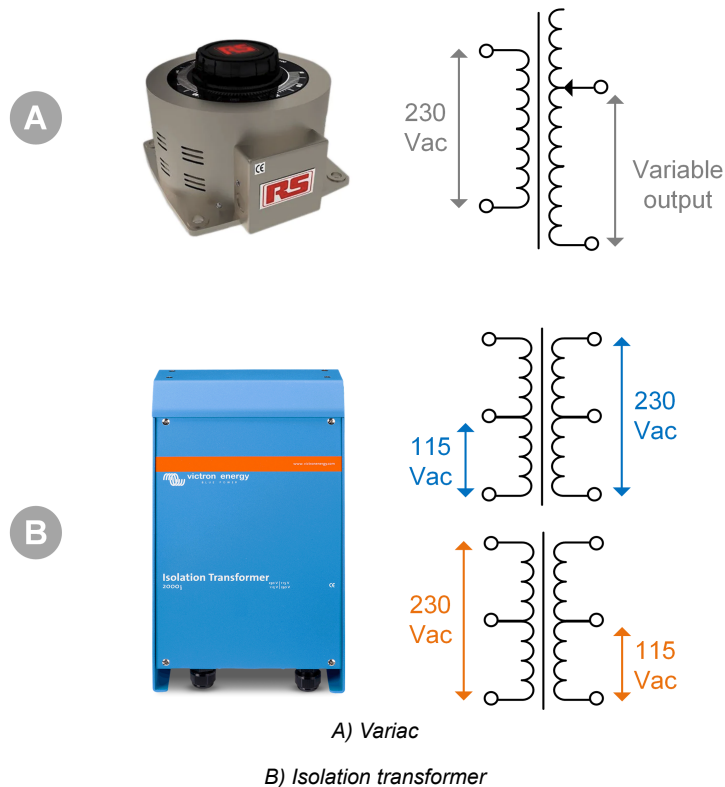

1.2.5. AC loads

Some examples of AC loads:

- Electric heaters.
- Incandescent AC lamps.

Note: Do not use heat guns (paint strippers). These are not suitable for load testing because they are non-linear loads, they do not load the whole sine wave equally.

1.2.6. Cables and interfaces

DC and AC cabling need to have the thicknesses recommended in the product manual of the tested unit.

Note that the DC cables and connectors between the DC supply and the to-be-tested device must be able to deal with the large DC currents that are common in low voltage systems. If too thin cables are used, this will lead to potential voltage drops and will interfere with the test results.

Required interfaces and data cables for bench testing Victron products:

- **Interface MK3-USB:** Use this to communicate with a computer via VE.Bus using the VictronConnect app or the VEConfigure software. See A in below image.
- **VE.Direct to USB interface:** Use this to communicate with a computer to the VE.Direct port. This is handy when the Windows version of the VictronConnect app is used. See B in below image.
- **VE.Direct Bluetooth Smart dongle:** Use this to communicate with Bluetooth via the VE.Direct port to bypass its built-in Bluetooth interface. This is handy in case the PIN of the product is unknown. See C in below image.
- **VE.Direct cable:** Use this to connect a GX device to a VE.Direct port.
- **RJ45 UTP cable:** Use this to connect an interface or a GX device to a VE.Bus or VE.Can port.
- **VE.Can RJ45 terminator:** Use this for VE.Can communication.
- **RJ12 UTP cable:** Use this between the BMV head unit and the BMV shunt. This is handy in case the BMV RJ12 UTP cable is missing or to rule out a cable issue.

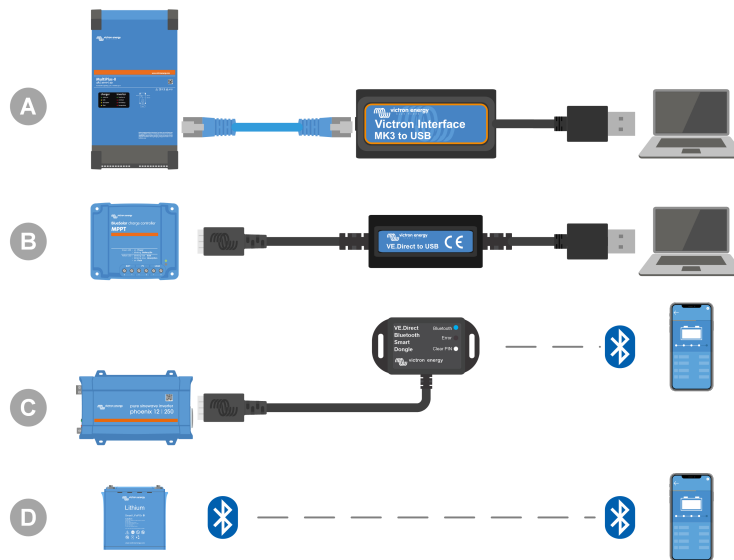

Example of connecting for configuration access.

| ID | Description |
|----|--|
| A | An Interface MK3-USB is used to connect VE.Bus units to a computer's USB port for access with the VictronConnect app or VEConfigure software. |
| B | A VE.Direct to USB interface is used to connect VE.Direct units to a computer's USB port for access with the VictronConnect app or VEConfigure software. |
| C | A VE.Direct Bluetooth Smart dongle is used to connect VE.Direct units via Bluetooth to a phone or tablet for access with the VictronConnect app. |
| D | A direct Bluetooth connection to a phone or tablet for access with the VictronConnect app |

1.2.7. Measurement equipment and software

The following measuring equipment and software are needed:

- A true RMS multimeter, such as a Fluke 87 multimeter.
- A DC current clamp. For example, the Fluke i1010 AC/DC Current Clamp i1010 AC/DC can be used together with the Fluke 87 multimeter.
- The [VictronConnect app](#) to monitor, configure or update the firmware.
- The [VE.Configuration tools](#) software package to configure or update VE.Bus products. However, it is essential to note that, in most cases, the VictronConnect app should be preferred for these tasks. The only exceptions are when setting or resetting grid codes, changing or removing assistants, or encountering issues with a firmware update.
- A [Cerbo GX](#) with a [GX Touch](#) screen and a [VRM](#) account. The Cerbo GX serves multiple purposes, including monitoring units, reading out errors, configuring settings, updating firmware, and providing remote access.
- A simple design oscilloscope (optional). If you decide to use an oscilloscope, ensure that you have a probe suitable for measuring 110Vac and 230Vac."

2. Pre-RMA test form - Inverter

1. General

| Product, system and fault information | |
|--|------|
| Date | |
| Model | |
| Part number | |
| Date of installation (if known) | |
| Date of failure (if known) | |
| Battery type, brand name and overall capacity (if known) | |

2. Initial check

| Initial check | |
|--|--|
| Does the unit have internal water damage or corrosion? | <input type="checkbox"/> Yes, no warranty. <input type="checkbox"/> No. |
| Are the internals of the unit very dirty, or is there soot, dust or oil present inside the unit? | <input type="checkbox"/> Yes, no warranty. <input type="checkbox"/> No. |
| Are there foreign objects inside the unit: like screws, animals or insects? | <input type="checkbox"/> Yes, no warranty. <input type="checkbox"/> No. |
| Does the unit have burn marks on its internal parts, or does it smell burned? | <input type="checkbox"/> Yes. <input type="checkbox"/> No. |
| Does the unit have mechanical damage to any of its internal parts? | <input type="checkbox"/> Yes, no warranty. <input type="checkbox"/> No. |
| Does the unit have external mechanical, water or corrosion damage? | <input type="checkbox"/> Yes, no warranty. <input type="checkbox"/> No. |
| Does the unit have burn marks or melting marks on its housing, or does it smell burned? | <input type="checkbox"/> Yes. <input type="checkbox"/> No. |
| Does the unit have mechanical or burn damage to its electrical connectors? | <input type="checkbox"/> Yes, no warranty. <input type="checkbox"/> No. |

3. First power up

| Power the unit up and check | |
|---|---|
| Remove all wires and cables from the unit. Connect the unit to a DC power supply or battery bank. Turn the DC supply on and turn the unit on via its main switch. Is there a DC short-circuit? | <input type="checkbox"/> Yes, lodge a warranty claim. <input type="checkbox"/> No. |
| Are there any LED(s) on or blinking? | <input type="checkbox"/> Yes, go to 4. <input type="checkbox"/> No. |

| Power the unit up and check | |
|---|--|
| <p>For Phoenix Inverter VE.Direct and Phoenix Inverter Compact only:</p> <p>Check the internal fuse and replace the fuse if it is broken. What is the outcome?</p> | <input type="checkbox"/> The fuse is not broken. <input type="checkbox"/> The replacement fuse blew, lodge a warranty claim. <input type="checkbox"/> Fuse replaced, there are no LEDs on or blinking. <input type="checkbox"/> Fuse replaced and LED(s) are on or blinking, go to 4. |
| <p>Check if the remote link is in place; if not, place the link. Are any LED(s) on or blinking now?</p> <p><u>Note:</u> To find the location of the remote link, refer to the product manual.</p> | <input type="checkbox"/> Yes, go to 4. <input type="checkbox"/> No. |

4. Bluetooth

| Bluetooth check | |
|--|---|
| <p>Is the unit a "Smart" product, i.e., does it have built-in Bluetooth?</p> | <input type="checkbox"/> Yes. <input type="checkbox"/> No, go to step 5. |
| <p>Is Bluetooth active, i.e., do you see the unit listed in the device list of the VictronConnect app?</p> | <input type="checkbox"/> Yes, go to step 5. <input type="checkbox"/> No. |
| <p>If Bluetooth is not active, it is unlikely to be a faulty Bluetooth module. More likely, Bluetooth has been turned off in the VictronConnect settings. To re-activate Bluetooth, consult the product manual.</p> <p>Is Bluetooth active now?</p> | <input type="checkbox"/> Yes, go to step 5. <input type="checkbox"/> No. |
| <p>If Bluetooth is still not active, rule out the following:</p> <ul style="list-style-type: none"> • Are there problems with your phone or tablet? • Are you within Bluetooth range? • Just one phone or tablet can connect via Bluetooth at once. If another is connected, the unit will be listed but greyed out in VictronConnect app. • Consult the product manual and the VictronConnect manual to try to resolve the Bluetooth issue. <p>Is Bluetooth active now?</p> | <input type="checkbox"/> Yes. <input type="checkbox"/> No, lodge a warranty claim. |

5. Firmware and settings

| Update the firmware and reset the settings to default | |
|--|---|
| <p>Connect via an interface (or Bluetooth) to the VictronConnect app and navigate to the unit. Is this possible?</p> | <input type="checkbox"/> Yes. <input type="checkbox"/> No, not possible; lodge a warranty claim. |
| <p>Check if the firmware is up to date. If the firmware is not up to date, update the firmware to the most recent version using the VictronConnect app:</p> <ul style="list-style-type: none"> • Go to the VictronConnect settings page. • On the settings page, click on the "3 dots" symbol in the top right-hand corner. • Select "Product info". • On the product info page, check and/or update the firmware. | <input type="checkbox"/> Yes, the firmware has been updated. <input type="checkbox"/> Yes, the firmware was already up to date. <input type="checkbox"/> No, not possible to update the firmware. |

| Update the firmware and reset the settings to default | |
|---|--|
| Save the unit's settings. File the settings under its serial number and keep the file on record for future reference. To save the settings: <ul style="list-style-type: none"> • Go to the VictronConnect settings page. • On the settings page, click on the "disk" symbol at the top. | <input type="checkbox"/> Yes, the settings file has been saved. <input type="checkbox"/> No, not possible to save the settings. |
| Reset all settings to default: <ul style="list-style-type: none"> • Go to the VictronConnect settings page. • On the settings page, click on the "3 dots" symbol in the top right-hand corner of the page and select "Reset to defaults". | <input type="checkbox"/> Yes, the settings are set to default. <input type="checkbox"/> No, not possible to set the settings to default. |
| Does the VictronConnect app display any error codes? If so, try to resolve the errors by consulting the product manual. Did it get resolved? | <input type="checkbox"/> No errors, go to 6. <input type="checkbox"/> There were errors, but they were resolved. <input type="checkbox"/> There were errors, but they were not resolved. |
| Write down the error number and name. | Error number: Error name: |

6. Functionality

| Inverter functionality check | |
|--|---|
| Measure the DC voltage at the DC connection terminals inside the unit. Is this voltage the same as the battery voltage reading in the VictronConnect app? | <input type="checkbox"/> Yes. <input type="checkbox"/> No, lodge warranty claim. |
| Measure the AC output using a True RMS multimeter. Are you measuring exactly 230Vac or 120Vac depending on the unit's AC voltage rating? | <input type="checkbox"/> Yes. <input type="checkbox"/> No, lodge warranty claim. |
| Does the measured AC voltage correspond with the AC voltage reading in the VictronConnect app? | <input type="checkbox"/> Yes. <input type="checkbox"/> No, lodge warranty claim. |
| Load the unit using incandescent light globes, electric heaters or any other type of resistive AC load. Can the unit power a load as high as its power rating without overload or temperature alarm? | <input type="checkbox"/> Yes. <input type="checkbox"/> No, lodge warranty claim. |
| Is the unit making an unusual noise? | <input type="checkbox"/> Yes, lodge a warranty claim. <input type="checkbox"/> No. |

7. Remarks

| Provide additional fault information or add issues not already covered in earlier questions |
|---|
| |
| |
| |
| |

8. RMA lodgement

| For your information purposes, provide details after lodging the RMA | |
|--|--|
| RMA type: | <input type="checkbox"/> Warranty claim. <input type="checkbox"/> Non-warranty repair or replacement request. |
| RMA lodgement date | |

| For your information purposes, provide details after lodging the RMA | |
|--|------|
| Victron Energy RMA number | |
| Your reference number | |

3. Pre-RMA test form - SUN Inverter

1. General

| Product, system and fault information | |
|--|------|
| Date | |
| Model | |
| Part number | |
| Date of installation (if known) | |
| Date of failure (if known) | |
| Battery type, brand name and overall capacity (if known) | |

2. Initial check

| Initial check | |
|--|--|
| Does the unit have internal water damage or corrosion? | <input type="checkbox"/> Yes, no warranty. <input type="checkbox"/> No. |
| Are the internals of the unit very dirty, or is there soot, dust or oil present inside the unit? | <input type="checkbox"/> Yes, no warranty. <input type="checkbox"/> No. |
| Are there foreign objects inside the unit: like screws, animals or insects? | <input type="checkbox"/> Yes, no warranty. <input type="checkbox"/> No. |
| Does the unit have burn marks on its internal parts, or does it smell burned? | <input type="checkbox"/> Yes. <input type="checkbox"/> No. |
| Does the unit have mechanical damage to any of its internal parts? | <input type="checkbox"/> Yes, no warranty. <input type="checkbox"/> No. |
| Does the unit have external mechanical, water or corrosion damage? | <input type="checkbox"/> Yes, no warranty. <input type="checkbox"/> No. |
| Does the unit have burn marks or melting marks on its housing, or does it smell burned? | <input type="checkbox"/> Yes. <input type="checkbox"/> No. |
| Does the unit have mechanical or burn damage to its electrical connectors? | <input type="checkbox"/> Yes, no warranty. <input type="checkbox"/> No. |

3. First power up

| Power the unit up and check | |
|--|---|
| Remove all wires and cables from the unit. Connect the battery connections to a battery bank. Turn the battery supply on and switch the unit on via its main switch. Is there a DC short-circuit? | <input type="checkbox"/> Yes, lodge a warranty claim. <input type="checkbox"/> No. |
| Are there any LED(s) on or blinking? | <input type="checkbox"/> Yes, go to 4. <input type="checkbox"/> No. |

| Power the unit up and check | |
|---|--|
| <p>For Phoenix Inverter VE.Direct and Phoenix Inverter Compact only:</p> <p>Check the internal fuse and replace the fuse if it is broken. What is the outcome?</p> | <input type="checkbox"/> The fuse is not broken. <input type="checkbox"/> The replacement fuse blew, lodge a warranty claim. <input type="checkbox"/> Fuse replaced, there are no LEDs on or blinking. <input type="checkbox"/> Fuse replaced and LED(s) are on or blinking, go to 4. |
| <p>Check if the remote link is in place; if not, place the link. Are any LED(s) on or blinking now?</p> <p><u>Note:</u> To find the location of the remote link, refer to the product manual.</p> | <input type="checkbox"/> Yes, go to 4. <input type="checkbox"/> No. |

4. Bluetooth

| Bluetooth check | |
|--|---|
| <p>Is the unit a "Smart" product, i.e., does it have built-in Bluetooth?</p> | <input type="checkbox"/> Yes. <input type="checkbox"/> No, go to step 5. |
| <p>Is Bluetooth active, i.e., do you see the unit listed in the device list of the VictronConnect app?</p> | <input type="checkbox"/> Yes, go to step 5. <input type="checkbox"/> No. |
| <p>If Bluetooth is not active, it is unlikely to be a faulty Bluetooth module. More likely, Bluetooth has been turned off in the VictronConnect settings. To re-activate Bluetooth, consult the product manual.</p> <p>Is Bluetooth active now?</p> | <input type="checkbox"/> Yes, go to step 5. <input type="checkbox"/> No. |
| <p>If Bluetooth is still not active, rule out the following:</p> <ul style="list-style-type: none"> • Are there problems with your phone or tablet? • Are you within Bluetooth range? • Just one phone or tablet can connect via Bluetooth at once. If another is connected, the unit will be listed but greyed out in VictronConnect app. • Consult the product manual and the VictronConnect manual to try to resolve the Bluetooth issue. <p>Is Bluetooth active now?</p> | <input type="checkbox"/> Yes. <input type="checkbox"/> No, lodge a warranty claim. |

5. Firmware and settings

| Update the firmware and reset the settings to default | |
|--|---|
| <p>Connect via an interface (or Bluetooth) to the VictronConnect app and navigate to the unit. Is this possible?</p> | <input type="checkbox"/> Yes. <input type="checkbox"/> No, not possible; lodge a warranty claim. |
| <p>Check if the firmware is up to date. If the firmware is not up to date, update the firmware to the most recent version using the VictronConnect app:</p> <ul style="list-style-type: none"> • Go to the VictronConnect settings page. • On the settings page, click on the "3 dots" symbol in the top right-hand corner. • Select "Product info". • On the product info page, check and/or update the firmware. | <input type="checkbox"/> Yes, the firmware has been updated. <input type="checkbox"/> Yes, the firmware was already up to date. <input type="checkbox"/> No, not possible to update the firmware. |

| Update the firmware and reset the settings to default | |
|--|--|
| <p>Save the unit's settings. File the settings under its serial number and keep the file on record for future reference. To save the settings:</p> <ul style="list-style-type: none"> • Go to the VictronConnect settings page. • On the settings page, click on the "disk" symbol at the top. | <input type="checkbox"/> Yes, the settings file has been saved. <input type="checkbox"/> No, not possible to save the settings. |
| <p>Reset all settings to default:</p> <ul style="list-style-type: none"> • Go to the VictronConnect settings page. • On the settings page, click on the "3 dots" symbol in the top right-hand corner of the page and select "Reset to defaults". | <input type="checkbox"/> Yes, the settings are set to default. <input type="checkbox"/> No, not possible to set the settings to default. |
| <p>Does the VictronConnect app display any error codes? If so, try to resolve the errors by consulting the product manual. Did it get resolved?</p> | <input type="checkbox"/> No errors, go to 6. <input type="checkbox"/> There were errors, but they were resolved. <input type="checkbox"/> There were errors, but they were not resolved. |
| <p>Write down the error number and name.</p> | <p>Error number: Error name:</p> |

6. Functionality

| Inverter functionality check | |
|---|---|
| <p>Measure the DC voltage at the DC connection terminals inside the unit. Is this voltage the same as the battery voltage reading in the VictronConnect app?</p> | <input type="checkbox"/> Yes. <input type="checkbox"/> No, lodge warranty claim. |
| <p>Measure the AC output using a True RMS multimeter. Are you measuring exactly 230Vac or 120Vac depending on the unit's AC voltage rating?</p> | <input type="checkbox"/> Yes. <input type="checkbox"/> No, lodge warranty claim. |
| <p>Does the measured AC voltage correspond with the AC voltage reading in the VictronConnect app?</p> | <input type="checkbox"/> Yes. <input type="checkbox"/> No, lodge warranty claim. |
| <p>Load the unit using incandescent light globes, electric heaters or any other type of resistive AC load. Can the unit power a load as high as its power rating without overload or temperature alarm?</p> | <input type="checkbox"/> Yes. <input type="checkbox"/> No, lodge warranty claim. |
| <p>Is the unit making an unusual noise?</p> | <input type="checkbox"/> Yes, lodge a warranty claim. <input type="checkbox"/> No. |

| Solar charger functionality check | |
|---|---|
| <p>Connect the PV input of the unit to an appropriate solar panel array or DC power supply with series resistors as specified in the Testing equipment, test bench and tools [1] chapter. Adjust the DC power supply to 20V for a 12V system, or 40V for a 24V system. Connect the SUN Inverter to a partly discharged battery. Measure the battery voltage. Is the voltage of the battery slowly increasing?</p> | <input type="checkbox"/> Yes. <input type="checkbox"/> No, lodge warranty claim. |
| <p>Is the battery being charged? Check if the charger is progressing through the "bulk", "absorption", "float", and "storage" charge stages. Is this the case?</p> | <input type="checkbox"/> Yes. <input type="checkbox"/> No, lodge warranty claim. |
| <p>Measure the charge current with a DC current clamp. Is the charge current the same as indicated in the VictronConnect app (a deviation of up to 1% is allowed)?</p> | <input type="checkbox"/> Yes. <input type="checkbox"/> No, lodge warranty claim. |
| <p>Force the unit to provide more charge current by using partly empty batteries or switch a large DC load on. Can the unit provide 100% of its rated charge current?</p> | <input type="checkbox"/> Yes. <input type="checkbox"/> No, lodge warranty claim. |

7. Remarks

| Provide additional fault information or add issues not already covered in earlier questions |
|---|
| |
| |
| |
| |

8. RMA lodgement

| For your information purposes, provide details after lodging the RMA | |
|--|--|
| RMA type: | <input type="checkbox"/> Warranty claim. <input type="checkbox"/> Non-warranty repair or replacement request. |
| RMA lodgement date | |
| Victron Energy RMA number | |
| Your reference number | |

4. Pre-RMA test form - Inverter/charger

1. General

| Product, system and fault information | |
|--|------|
| Date | |
| Model | |
| Part number | |
| Date of installation (if known) | |
| Date of failure (if known) | |
| Battery type, brand name and overall capacity (if known) | |

2. Initial check

| Initial check | |
|--|--|
| Does the unit have internal water damage or corrosion? | <input type="checkbox"/> Yes, no warranty. <input type="checkbox"/> No. |
| Are the internals of the unit very dirty, or is there soot, dust or oil present inside the unit? | <input type="checkbox"/> Yes, no warranty. <input type="checkbox"/> No. |
| Are there foreign objects inside the unit: like screws, animals or insects? | <input type="checkbox"/> Yes, no warranty. <input type="checkbox"/> No. |
| Does the unit have burn marks on its internal parts, or does it smell burned? | <input type="checkbox"/> Yes. <input type="checkbox"/> No. |
| Does the unit have mechanical damage to any of its internal parts? | <input type="checkbox"/> Yes, no warranty. <input type="checkbox"/> No. |
| Does the unit have external mechanical, water or corrosion damage? | <input type="checkbox"/> Yes, no warranty. <input type="checkbox"/> No. |
| Does the unit have burn marks or melting marks on its housing, or does it smell burned? | <input type="checkbox"/> Yes. <input type="checkbox"/> No. |
| Does the unit have mechanical or burn damage to its electrical connectors? | <input type="checkbox"/> Yes, no warranty. <input type="checkbox"/> No. |

3. First power up

| Power the unit up and check | |
|---|---|
| Remove all wires and cables from the unit. Connect the unit to a DC power supply or battery bank. Turn the DC supply on and turn the unit on via its main switch. Is there a DC short-circuit? | <input type="checkbox"/> Yes, lodge a warranty claim. <input type="checkbox"/> No. |
| Are there any LED(s) on or blinking? | <input type="checkbox"/> Yes, go to 4. <input type="checkbox"/> No. |

| Power the unit up and check | |
|---|---|
| <p><u>For MultiPlus 500-1600VA or MultiPlus Compact only:</u></p> <p>Check the internal fuse and replace the fuse if it is broken. What is the outcome?</p> | <input type="checkbox"/> The fuse is not broken. <input type="checkbox"/> The replacement fuse blew, lodge a warranty claim. <input type="checkbox"/> Fuse replaced, no LED(s) are on or blinking. <input type="checkbox"/> Fuse replaced, LED(s) are on or blinking, go to 4. |
| <p><u>For all units except the MultiPlus Compact:</u></p> <p>Check if the remote link is in place; if not, place the link. Are any LED(s) on or blinking now?</p> <p><u>Note:</u> To find the location of the remote link, refer to the product manual.</p> | <input type="checkbox"/> Yes, go to 4. <input type="checkbox"/> No. |
| <p><u>For the MultiPlus Compact:</u></p> <p>Check the DIP switches. DIP switch 1 should be set to "off", and DIP switch 2 should be set to "on". If this is not the case, set DIP switch 1 to "off" and set DIP switch 2 to "on". Are any LED(s) on or blinking now?</p> <p><u>Note:</u> For more information on the DIP switches, see the product manual, chapter 5.5.</p> | <input type="checkbox"/> Yes, go to 4. <input type="checkbox"/> No. |

4. Bluetooth

| Bluetooth check | |
|--|---|
| Is the unit a "Smart" product, i.e., does it have built-in Bluetooth? | <input type="checkbox"/> Yes. <input type="checkbox"/> No, go to step 5. |
| Is Bluetooth active, i.e., do you see the unit listed in the device list of the VictronConnect app? | <input type="checkbox"/> Yes, go to step 5. <input type="checkbox"/> No. |
| <p>If Bluetooth is not active, it is unlikely to be a faulty Bluetooth module. More likely, Bluetooth has been turned off in the VictronConnect settings. To re-activate Bluetooth, consult the product manual.</p> <p>Is Bluetooth active now?</p> | <input type="checkbox"/> Yes, go to step 5. <input type="checkbox"/> No. |
| <p>If Bluetooth is still not active, rule out the following:</p> <ul style="list-style-type: none"> • Are there problems with your phone or tablet? • Are you within Bluetooth range? • Just one phone or tablet can connect via Bluetooth at once. If another is connected, the unit will be listed but greyed out in VictronConnect app. • Consult the product manual and the VictronConnect manual to try to resolve the Bluetooth issue. <p>Is Bluetooth active now?</p> | <input type="checkbox"/> Yes. <input type="checkbox"/> No, lodge a warranty claim. |

5. Firmware and settings

| Update the firmware and reset the settings to default | |
|---|---|
| Connect via an interface (or Bluetooth) to the VictronConnect app and navigate to the unit. Is this possible? | <input type="checkbox"/> Yes. <input type="checkbox"/> No, not possible; lodge a warranty claim. |

| Update the firmware and reset the settings to default | |
|--|---|
| <p>Check if the firmware is up to date. If the firmware is not up to date, update the firmware to the most recent version using the VictronConnect app:</p> <ul style="list-style-type: none"> Go to the VictronConnect settings page. On the settings page, click on the "3 dots" symbol in the top right-hand corner. Select "Product info". On the product info page, check and/or update the firmware. <div style="border: 1px solid #0070C0; border-radius: 10px; padding: 5px; margin-top: 10px;">  If a firmware update is not possible using the VictronConnect app, try using VE.Flash instead. </div> | <input type="checkbox"/> Yes, the firmware has been updated. <input type="checkbox"/> Yes, the firmware was already up to date. <input type="checkbox"/> No, not possible to update the firmware. |
| <p>Save the unit's settings. File the settings under its serial number and keep the file on record for future reference. To save the settings:</p> <ul style="list-style-type: none"> Go to the VictronConnect settings page. On the settings page, click on the "disk" symbol at the top. | <input type="checkbox"/> Yes, the settings file has been saved. <input type="checkbox"/> No, not possible to save the settings. |
| <p>Reset all settings to default: <u>For all models except RS models:</u></p> <ul style="list-style-type: none"> Connect with VE.Configure. Go to the "Defaults" menu and click "Set all settings to default" Navigate to the "Assistant" tab and delete all assistants. <p><u>For the RS models:</u></p> <ul style="list-style-type: none"> Go to the VictronConnect settings page. On the settings page, click on the "3 dots" symbol in the top right-hand corner of the page and select "Reset to defaults". | <input type="checkbox"/> Yes, the settings are set to default. <input type="checkbox"/> No, not possible to set the settings to default. |
| <p>Does the VictronConnect app display any error codes? If so, try to resolve the errors by consulting the product manual. Did it get resolved?</p> | <input type="checkbox"/> No errors, go to 6. <input type="checkbox"/> There were errors, but they were resolved. <input type="checkbox"/> There were errors, but they were not resolved. |
| <p>Write down the error number and name.</p> | <p>Error number: Error name:</p> |

6. Functionality

| Inverter functionality check | |
|---|---|
| <p>Measure the DC voltage at the DC connection terminals inside the unit. Is this voltage the same as the battery voltage reading in the VictronConnect app?</p> | <input type="checkbox"/> Yes. <input type="checkbox"/> No, lodge a warranty claim. |
| <p>Measure the AC output using a True RMS multimeter. Are you measuring exactly 230Vac or 120Vac depending on the unit's AC voltage rating?</p> | <input type="checkbox"/> Yes. <input type="checkbox"/> No, lodge a warranty claim. |
| <p>Does the measured AC voltage correspond with the AC voltage reading in the VictronConnect app?</p> | <input type="checkbox"/> Yes. <input type="checkbox"/> No, lodge a warranty claim. |
| <p>Load the unit using incandescent light globes, electric heaters or any other type of resistive AC load. Can the unit power a load as high as its power rating without overload or temperature alarm?</p> | <input type="checkbox"/> Yes. <input type="checkbox"/> No, lodge a warranty claim. |
| <p>Is the unit making an unusual noise?</p> | <input type="checkbox"/> No. <input type="checkbox"/> Yes, lodge a warranty claim. |

Ground relay and back-feed relay safety circuit check - Only applicable to MultiPlus-II, EasySolar-II and Quattro-II

Scope: Bench test for unit reporting an Error 8 (ground relay) or Error 11 (back-feed relays).

Preparations, check the bench test supply:

Measure the voltage between ground/earth and neutral. Ensure that it is below 30Vac. Usually the voltage between ground and neutral does not exceed a few volts.

- A voltage of around 230Vac indicates that line and neutral are swapped. Fix that before continuing.
- A voltage above 30Vac indicates problem in the grounding of either the test bench or the installation of the building. This needs to be fixed prior to continuing the test.

Note that this bench test can only be conducted if the voltage between ground/earth and neutral is below 30Vac.

Benchtest:

1. Switch the unit off.
2. Connect a battery or power supply to the battery terminals.
3. Connect AC input to the unit, including ground/earth. Make sure not to swap line and neutral.
4. Double check line and neutral position by measuring the AC voltage between neutral and ground. This should not be above a few Volts maximum.
5. Do not connect anything to the AC output terminals.
6. Switch the unit on.
7. Update the firmware to the latest version. If already on latest version, use VEConfigure to reset all settings to default (in the top menu select "Defaults" and then select "Set all settings to default").
8. Use VEConfigure and select the grid code "Other: not compliant to any grid code standard".
Do not use a gid code with "AC Neutral path externally joined".
9. Send all settings.
10. Ensure that nothing is connected to the AC output terminals.

- Yes, the unit is working as expected.
- No, lodge warranty claim.

CHECK: Does the unit start up and connect to the grid without errors?

Background information: when wired with correct line, neutral and ground connections on the AC input, and nothing is connected to the output, if the unit works both in island mode (inverting) and connects to the grid (charging), then all relays and their testing circuits are OK. If the unit gives problems in the field, despite passing this bench test, then there is an issue in the electrical installation and the troubleshooting steps for [Error 8](#) (ground relay) and [Error 11](#) (back-feed relays) must be followed.

Transfer switch check

- Connect the AC input and switch the unit on.

Check if, after a few seconds, the AC input switches over to the AC output and the unit starts charging the battery.

- Yes.
- No, lodge warranty claim.

For 3kVA units and above:

Measure the voltage of the second AC output. Do you measure the same voltage as the AC input after a 2-minute delay?

- Yes.
- No, lodge warranty claim.

For Quattros only:

Repeat the above steps for the second input (AC2-in). Has this been successful?

- Yes.
- No, lodge warranty claim.

| Charger functionality check | |
|--|---|
| Connect the charger to a partly discharged battery. Measure the battery voltage. Is the voltage of the battery slowly increasing? | <input type="checkbox"/> Yes. <input type="checkbox"/> No, lodge warranty claim. |
| Is the battery being charged? Check if the charger is progressing through the "bulk", "abs", "float", and "storage" charge stages. Is this the case? | <input type="checkbox"/> Yes. <input type="checkbox"/> No, lodge warranty claim. |
| Measure the charge current with a DC current clamp. Is the charge current the same as indicated in the VictronConnect app (a deviation of up to 1% is allowed)? | <input type="checkbox"/> Yes. <input type="checkbox"/> No, lodge warranty claim. |
| Force the unit to provide more charge current by using partly empty batteries or switch a large DC load on. Can the unit provide 80% of its rated charge current (80% is the default setting)? | <input type="checkbox"/> Yes. <input type="checkbox"/> No, lodge warranty claim. |

| Additional functionality check | |
|--|---|
| <u>For GX units only:</u> Check the functionality of the GX device. Is the GX device operating correctly? | <input type="checkbox"/> Yes. <input type="checkbox"/> No, lodge warranty claim. |
| <u>For EasySolar units only:</u> Check the operation of the solar charger using the solar charger MPPT pre-RMA test form [24] . Is the solar charger operating correctly? | <input type="checkbox"/> Yes. <input type="checkbox"/> No, lodge warranty claim. |

7. Remarks

| Provide additional fault information or add issues not already covered in earlier questions |
|---|
| |
| |
| |
| |

8. RMA lodgement

| For your information purposes, provide details after lodging the RMA | |
|--|--|
| RMA type: | <input type="checkbox"/> Warranty claim. <input type="checkbox"/> Non-warranty repair or replacement request. |
| RMA lodgement date | |
| Victron Energy RMA number | |
| Your reference number | |

5. Pre-RMA test form - Smart charger

1. General

| Product, system and fault information | |
|--|------|
| Date | |
| Model | |
| Part number | |
| Date of installation (if known) | |
| Date of failure (if known) | |
| Battery type, brand name and overall capacity (if known) | |

2. Initial check

| Initial check | |
|---|--|
| Does the unit have mechanical damage to its housing? | <input type="checkbox"/> Yes, no warranty. <input type="checkbox"/> No. |
| Does the unit have burn marks or melting marks on its housing, or does it smell burned? | <input type="checkbox"/> Yes. <input type="checkbox"/> No. |
| Does the unit have mechanical or burn damage to its electrical wires or connectors? | <input type="checkbox"/> Yes, no warranty. <input type="checkbox"/> No. |

3. First power up

| Power the unit up and check | |
|--|--|
| Connect the unit to an AC power supply. The unit should turn on automatically. Is there an AC short-circuit? | <input type="checkbox"/> Yes, lodge a warranty claim. <input type="checkbox"/> No. |
| Are any of the LEDs on? | <input type="checkbox"/> Yes. <input type="checkbox"/> No. |
| <u>For IP22, IP67 and some IP65 chargers only:</u> Remove the fuse, and check it for continuity. If the fuse is broken, replace the fuse. What is the outcome? | <input type="checkbox"/> The fuse is not broken. <input type="checkbox"/> The fuse was broken, and the fuse has been replaced without issues. <input type="checkbox"/> The fuse was broken, and the replacement fuse blew; lodge a warranty claim. |
| <u>For IP43 chargers only:</u> Check if the remote link is in place. If the remote link is not in place, place the link. What is the outcome? <u>Note:</u> To find the location of the remote link, refer to the product manual. | <input type="checkbox"/> The link was placed. <input type="checkbox"/> The link was not placed and has now been placed. |

Power the unit up and check

Measure the voltage on the charger battery terminal(s) or cables. If the charger has multiple charge outputs, measure the voltage on each output. Do you measure at least 12V or 24V on the output(s) (depending on the charger model)?

For IP65 chargers only: First, unplug the DC connector from the accessory cable (the eyelet or clamp terminal cable) and measure the DC voltage on the DC connector closest to the charger. Then plug the connector into the accessory cable and measure the DC voltage on the eyelet or clamp terminals. Do you measure at least 12V or 24V (depending on the charger model)?

- Yes, go to 4.
 No.

4. Bluetooth**Bluetooth check**

Is the unit a "Smart" product, i.e., does it have built-in Bluetooth?

- Yes.
 No, go to step 5.

Is Bluetooth active, i.e., do you see the unit listed in the device list of the VictronConnect app?

- Yes, go to step 5.
 No.

If Bluetooth is not active, it is unlikely to be a faulty Bluetooth module. More likely, Bluetooth has been turned off in the VictronConnect settings. To re-activate Bluetooth:

- Press and hold the "mode" button for 10 seconds to turn Bluetooth back on.

Is Bluetooth active now?

- Yes, go to step 5.
 No.

If Bluetooth is still not active, rule out the following:

- Are there problems with your phone or tablet?
- Are you within Bluetooth range?
- Just one phone or tablet can connect via Bluetooth at once. If another is connected, the unit will be listed but greyed out in VictronConnect app.
- Consult the product manual and the [VictronConnect manual](#) to try to resolve the Bluetooth issue.

Is Bluetooth active now?

- Yes.
 No, lodge a warranty claim.

5. Firmware and settings**Update the firmware and reset the settings to default**

Connect via Bluetooth (or interface) to the VictronConnect app and navigate to the unit. Is this possible?

In case the PIN code is unknown, reset the PIN code, using the PUK code. For information on how to do this, see the [VictronConnect manual](#).

- Yes.
 No, not possible; lodge a warranty claim.

Check if the firmware is up to date. If the firmware is not up to date, update the firmware to the most recent version using the VictronConnect app:

- Go to the VictronConnect settings page.
- On the settings page, click on the "3 dots" symbol in the top right-hand corner.
- Select "Product info".
- On the product info page, check and/or update the firmware.

- Yes, the firmware has been updated.
 Yes, the firmware was already up to date.
 No, not possible to update the firmware.

| Update the firmware and reset the settings to default | |
|--|---|
| <p>Save the unit's settings. File the settings under its serial number and keep the file on record for future reference. To save the settings:</p> <ul style="list-style-type: none"> • Go to the VictronConnect settings page. • On the settings page, click on the "disk" symbol at the top. | <input type="checkbox"/> Yes, the settings file has been saved. <input type="checkbox"/> No, not possible to save the settings. |
| <p>Reset all settings to default:</p> <ul style="list-style-type: none"> • Go to the VictronConnect settings page. • On the settings page, click on the "3 dots" symbol in the top right-hand corner of the page and select "Reset to defaults". | <input type="checkbox"/> Yes, the settings are set to default. <input type="checkbox"/> No, not possible to set the settings to default. |
| <p>Does the VictronConnect app display any active error codes? If so, try to resolve the errors by consulting the product manual. Did it get resolved?</p> | <input type="checkbox"/> No errors. <input type="checkbox"/> There were errors, but they were resolved. <input type="checkbox"/> There were errors, but they were not resolved. |
| <p>If there is an active error, write down the error number(s) and name(s). Use this form's "Remarks" section if more space is needed.</p> | Error number: Error name: |
| <p>Check the history. Were there any historical errors? If so, write them down. Save a copy of the history file for your reference.</p> | <input type="checkbox"/> Yes, Number(s): <input type="checkbox"/> No. |

6. Functionality

| Charger functionality check | |
|--|---|
| <p>Set the charger to "normal" mode. To do this: press the "mode" button until the "normal" LED is illuminated. If the charger does not have a "mode" button, do this via the VictronConnect app.</p> | <input type="checkbox"/> The charger has been set to "normal" mode. <input type="checkbox"/> Not possible; the mode button is broken. |
| <p>Measure the voltage on the charger battery terminal(s). Do you measure at least 12V or 24V (depending on the charger model)?</p> | <input type="checkbox"/> Yes. <input type="checkbox"/> No, lodge a warranty claim. |
| <p>Compare the measured voltage to the voltage indicated in the VictronConnect app. Are they both the same (a deviation of up to 1% is allowed)?</p> | <input type="checkbox"/> Yes. <input type="checkbox"/> No, lodge a warranty claim. |
| <p>Connect the charger to a partly discharged battery. Measure the battery voltage. Is the voltage of the battery slowly increasing?</p> | <input type="checkbox"/> Yes. <input type="checkbox"/> No, lodge a warranty claim. |
| <p>Is the battery being charged? Check if the charger progresses through the bulk, absorption, float, and storage charge stages. Is this the case?</p> | <input type="checkbox"/> Yes. <input type="checkbox"/> No, lodge a warranty claim. |
| <p>Force the charger to provide more charge current by connecting it to an empty battery or by switching on a large DC load connected to the same battery. Is the unit able to provide its full current rating?</p> | <input type="checkbox"/> Yes. <input type="checkbox"/> No, lodge a warranty claim. |
| <p>Measure the charge current with a DC current clamp. Is the charge current the same as indicated in the VictronConnect app (a deviation of up to 1% is allowed)?</p> | <input type="checkbox"/> Yes. <input type="checkbox"/> No, lodge a warranty claim. |
| <p><u>For the IP65 and IP67 chargers only:</u> While the charger is providing the full current, measure the battery voltage. Compare this to the voltage as indicated in the VictronConnect app. Do the voltages deviate less than 3% from each other?</p> | <input type="checkbox"/> Yes. <input type="checkbox"/> No. This is probably not warrantable as bad cables, or cable connectors can cause it. |

7. Remarks

| Provide additional fault information or add issues not already covered in earlier questions |
|---|
| |
| |
| |
| |

8. RMA lodgement

| For your information purposes, provide details after lodging the RMA | |
|--|--|
| RMA type: | <input type="checkbox"/> Warranty claim. <input type="checkbox"/> Non-warranty repair or replacement request. |
| RMA lodgement date | |
| Victron Energy RMA number | |
| Your reference number | |

6. Pre-RMA test form - MPPT solar charger

1. General

| Product, system and fault information | |
|--|------|
| Date | |
| Model | |
| Part number | |
| Date of installation (if known) | |
| Date of failure (if known) | |
| Battery type, brand name and overall capacity (if known) | |
| Solar array power rating (W) | |
| Solar array maximum open-circuit voltage (V) | |

2. Initial check

| Initial check | |
|---|---|
| Does the unit have mechanical damage to its housing? | <input type="checkbox"/> Yes, no warranty. <input type="checkbox"/> No. |
| Does the unit have burn marks or melting marks on its housing, or does it smell burned? | <input type="checkbox"/> Yes. <input type="checkbox"/> No. |
| Does the unit have mechanical or burn damage to its electrical connectors? | <input type="checkbox"/> Yes, no warranty. <input type="checkbox"/> No. |
| <p><u>For the 15A model only:</u></p> <p>Is there sand coming out of the unit?</p> <p><u>Background information:</u> Sand is used as a cooling agent. If the unit has sustained mechanical damage, like being dropped from a height onto a hard floor, the unit might get damaged so that sand is coming out of the unit. Mechanical damage is not covered by warranty.</p> | <input type="checkbox"/> Yes, not covered by warranty if caused by mechanical damage. <input type="checkbox"/> No. |

3. First power up

| Power the unit up and check | |
|--|---|
| <p>Power the solar charger using either a bench power supply set to 12V with a current limit of 0.5A, connected to the battery terminals, or use a 12V battery with a 0.5A fuse in the positive supply.</p> <p>Are any LED(s) on or blinking?</p> <p><u>Background information:</u> If none of the LEDs are on or are blinking, this usually signals that the internal, non-replaceable fuse has blown due to a reverse battery polarity connection. Note that reverse battery polarity is not covered under the warranty.</p> | <input type="checkbox"/> Yes. <input type="checkbox"/> No, and there was reverse battery polarity; no warranty. <input type="checkbox"/> No, and there was no reverse battery polarity; lodge a warranty claim. |

| Power the unit up and check | |
|--|---|
| <p><u>For 10A, 15A and 20A models only:</u></p> <p>Remove the fuse and check the fuse for continuity. If the fuse is broken, replace the fuse. What is the outcome?</p> <p><u>Background information:</u> If the replacement fuse blows, the solar charger has a short circuit; this is almost always an indication that the solar charger has been connected to reverse battery polarity. Reverse battery polarity is not covered under warranty.</p> | <input type="checkbox"/> The fuse is not broken. <input type="checkbox"/> The replacement fuse blew, and there was reverse battery polarity; no warranty. <input type="checkbox"/> The replacement fuse blew, and there was no reverse polarity; lodge a warranty claim. <input type="checkbox"/> The fuse was broken and has been replaced. |
| <p><u>For VE.Can MPPT 250/100, models only, with serial number HQ2150 and above:</u></p> <p>Check for a short circuit between the two PV connectors, use a multimeter in resistance mode.</p> <p>If a short circuit is detected, perform the following steps to reset the PV short relay:</p> <ol style="list-style-type: none"> 1. Power the solar charger with a bench power supply set to 12V and a current limit of 0.4A connected to the battery terminals. 2. Leave the PV terminals disconnected. 3. Open the VictronConnect app and go to the "Settings" page, then to the "Product Info" page. 4. Check the "Product Info" page for the PV Short reset feature. This feature is only available if the connected unit has the protection (e.g. 250/100 VE.Can model, HQ2150 and later), battery voltage is between 10 and 15V, VictronConnect v.580 or later is installed, and firmware version v3.12 or later is installed. 5. Click the PV Short relay RESET button. Wait for a few seconds until the button turns blue again, and a click might be heard from the solar charger. <p><u>Background information:</u> This model of the solar charger has a safety latching relay that can cause a short circuit between the PV terminals if tripped. The reset procedure resets the relay and resolves the short-circuit issue. For more information see this link: https://www.victronenergy.com/live/mppt_pv_short_relay_reset.</p> | <input type="checkbox"/> No, go to the next step. <input type="checkbox"/> Yes, and the reset procedure fixed it, go to the next step. <input type="checkbox"/> Yes, and the reset procedure did not fix it, lodge a warranty claim. |
| <p>Power the solar charger using either a bench power supply set to 12V with a current limit of 0.5A, connected to the PV terminals, or use a 12V battery with a 0.5A fuse in the positive supply.</p> <p>Is there a DC short-circuit?</p> <p><u>Background information:</u> A short circuit on the PV terminals is nearly always an indication that the solar charger has been connected to a too high PV voltage or there has been a too high short circuit current (can occur when there is PV reverse polarity and PV array is too big). Both situations are not covered under warranty. The maximum PV open circuit voltage and maximum PV short circuit current are indicated in the product manual and datasheet.</p> | <input type="checkbox"/> No. <input type="checkbox"/> Yes, and there was too much open circuit PV voltage or too much PV polarity short circuit current; no warranty. <input type="checkbox"/> Yes, and there was not too much open circuit PV voltage or too much PV polarity short circuit; lodge a warranty claim. |
| <p>Are any LED(s) on or blinking?</p> | <input type="checkbox"/> Yes, go to 4. <input type="checkbox"/> No. |
| <p><u>For models with a remote link only:</u></p> <p>Check if the remote link is in place; if not, place the link. Are any LED(s) on or blinking now?</p> <p><u>Note:</u> To find the location of the remote link, refer to the product manual.</p> | <input type="checkbox"/> Yes. <input type="checkbox"/> No, lodge a warranty claim. |

4. Bluetooth

| Bluetooth check | |
|--|---|
| Is the unit a "Smart" product, i.e., does it have built-in Bluetooth? | <input type="checkbox"/> Yes. <input type="checkbox"/> No, go to step 5. |
| Is Bluetooth active, i.e., do you see the unit listed in the device list of the VictronConnect app? | <input type="checkbox"/> Yes, go to step 5. <input type="checkbox"/> No. |
| <p>If Bluetooth is not active, it is unlikely to be a faulty Bluetooth module. More likely, Bluetooth has been turned off in the VictronConnect settings.</p> <p>To re-activate Bluetooth:</p> <ol style="list-style-type: none"> 1. Connect to the unit's VE.Direct port using a VE.Direct to USB interface and a computer, android phone or android tablet. 2. Open the VictronConnect app and navigate to the unit's "Settings" page. 3. From the "Settings" page, go to the "Product Info" page. 4. Verify if Bluetooth is enabled. If it is not enabled, activate it. <p>Is Bluetooth active now?</p> | <input type="checkbox"/> Yes, go to step 5. <input type="checkbox"/> No. |
| <p>If Bluetooth is still not active, rule out the following:</p> <ul style="list-style-type: none"> • Are there problems with your phone or tablet? • Are you within Bluetooth range? • Just one phone or tablet can connect via Bluetooth at once. If another is connected, the unit will be listed but greyed out in VictronConnect app. • Consult the product manual and the VictronConnect manual to try to resolve the Bluetooth issue. <p>Is Bluetooth active now?</p> | <input type="checkbox"/> Yes. <input type="checkbox"/> No, lodge a warranty claim. |

5. Firmware and settings

| Update the firmware and reset the settings to default | |
|--|---|
| Connect via an interface (or Bluetooth) to the VictronConnect app and navigate to the unit. Is this possible? | <input type="checkbox"/> Yes. <input type="checkbox"/> No, not possible; lodge a warranty claim. |
| <p>Check if the firmware is up to date. If the firmware is not up to date, update the firmware to the most recent version using the VictronConnect app:</p> <ul style="list-style-type: none"> • Go to the VictronConnect settings page. • On the settings page, click on the "3 dots" symbol in the top right-hand corner. • Select "Product info". • On the product info page, check and/or update the firmware. | <input type="checkbox"/> Yes, the firmware has been updated. <input type="checkbox"/> Yes, the firmware was already up to date. <input type="checkbox"/> No, not possible to update the firmware. |
| <p>Save the unit's settings. File the settings under its serial number and keep the file on record for future reference. To save the settings:</p> <ul style="list-style-type: none"> • Go to the VictronConnect settings page. • On the settings page, click on the "disk" symbol at the top. | <input type="checkbox"/> Yes, the settings file has been saved. <input type="checkbox"/> No, not possible to save the settings. |

| Update the firmware and reset the settings to default | |
|---|---|
| Reset all settings to default: <ul style="list-style-type: none"> Go to the VictronConnect settings page. On the settings page, click on the "3 dots" symbol in the top right-hand corner of the page and select "Reset to defaults". | <input type="checkbox"/> Yes, the settings are set to default. <input type="checkbox"/> No, not possible to set the settings to default. |
| Does the VictronConnect app display any active error codes? If so, try to resolve the errors by consulting the product manual. Did it get resolved? | <input type="checkbox"/> No errors. <input type="checkbox"/> There were errors, but they were resolved. <input type="checkbox"/> There were errors, but they were not resolved. |
| If there is an active error, write down the error number(s) and name(s). Use this form's "Remarks" section if more space is needed. | Error number: Error name: |
| Check the history. Were there any historical errors? If so, write them down. Save a copy of the history file for your reference. | <input type="checkbox"/> Yes, Number(s): <input type="checkbox"/> No. |
| Check the history. What was the highest PV voltage recorded? Compare this to the rated maximum PV voltage of the solar charger. Has the PV voltage been higher than the rated maximum voltage? | <input type="checkbox"/> Yes, highest PV voltage: <input type="checkbox"/> No. |

6. Functionality

| Solar charger functionality check | |
|--|---|
| Prepare the solar charger for the functionality test: <ul style="list-style-type: none"> Connect the battery terminals to a 12V battery. Connect the PV terminals to a 24V power supply or 24V battery. Connect the VictronConnect app with the solar charger. Go to the settings page and set the "battery voltage" to 12V. | <input type="checkbox"/> Done. |
| Measure the voltage on the solar charger PV terminals. Compare this to the solar voltage as indicated in the VictronConnect app. Are they both the same (a deviation of up to 1% is allowed)? | <input type="checkbox"/> Yes. <input type="checkbox"/> No, lodge a warranty claim. |
| Measure the voltage on the solar charger battery terminals. Compare this to the battery voltage as indicated in the VictronConnect app. Are they both the same (a deviation of up to 1% is allowed)? | <input type="checkbox"/> Yes. <input type="checkbox"/> No, lodge a warranty claim. |
| Is the battery being charged? Check if the solar charger is progressing through the bulk, absorption and float charge stages. Is this the case? | <input type="checkbox"/> Yes. <input type="checkbox"/> No, lodge a warranty claim. |
| Force the solar charger to provide more charge current by connecting it to an empty battery or by switching on a large DC load connected to the same battery. Is the unit able to provide its full current rating? | <input type="checkbox"/> Yes. <input type="checkbox"/> No, lodge a warranty claim. |
| Measure the charge current with a DC current clamp. Is the charge current the same as indicated in the VictronConnect app (a deviation of up to 1% is allowed)? | <input type="checkbox"/> Yes. <input type="checkbox"/> No, lodge a warranty claim. |
| While the solar charger is providing the full current, measure the battery voltage. Compare this to the voltage as indicated in the VictronConnect app. Do the voltages deviate less than 3% from each other? | <input type="checkbox"/> Yes. <input type="checkbox"/> No. This is probably not warrantable as bad cables, or cable connectors can cause it. |

7. Remarks

| Provide additional fault information or add issues not already covered in earlier questions |
|---|
| |
| |

Provide additional fault information or add issues not already covered in earlier questions

....

....

8. RMA lodgement

For your information purposes, provide details after lodging the RMA

| | |
|---------------------------|--|
| RMA type: | <input type="checkbox"/> Warranty claim. |
| | <input type="checkbox"/> Non-warranty repair or replacement request. |
| RMA lodgement date | |
| Victron Energy RMA number | |
| Your reference number | |

7. Pre-RMA test form - BMV battery monitors

1. General

| Product, system and fault information | |
|--|------|
| Date | |
| Model | |
| Part number | |
| Date of installation (if known) | |
| Date of failure (if known) | |
| Battery type, brand name and overall capacity (if known) | |

2. Initial check

| Initial check | |
|--|---|
| Does the shunt have mechanical, water or corrosion damage? | <input type="checkbox"/> Yes, no warranty; replace the shunt. <input type="checkbox"/> No. |
| Does the shunt have damage to its electrical connectors? | <input type="checkbox"/> Yes, no warranty; replace the shunt. <input type="checkbox"/> No. |
| Does the shunt board have mechanical, water or corrosion damage? | <input type="checkbox"/> Yes, no warranty; replace the shunt board. <input type="checkbox"/> No. |
| Does the shunt board have damage to its electrical connectors? | <input type="checkbox"/> Yes, no warranty; replace the shunt board. <input type="checkbox"/> No. |
| Is the shunt board securely fastened to the shunt? | <input type="checkbox"/> Yes. <input type="checkbox"/> No, tighten both screws. |
| Does the head unit have mechanical, water or corrosion damage? | <input type="checkbox"/> Yes, no warranty; replace the head unit. <input type="checkbox"/> No. |
| Does the head unit have damage to any of its electrical connectors? | <input type="checkbox"/> Yes, no warranty; replace the head unit. <input type="checkbox"/> No. |
| Does the head unit have burn marks or melting marks on its housing, or smell burned? | <input type="checkbox"/> Yes. <input type="checkbox"/> No. |
| Remove the fuse from the red power cable and test the fuse for continuity using a digital multimeter. In the case of a BMV 702 or 712, repeat this test for the fuse in the other cable. | <input type="checkbox"/> Yes, no warranty; replace the fuse. <input type="checkbox"/> No. |
| Test the red cable(s) for continuity using a multimeter. And inspect the cable(s) for damage. Is there an issue with the cable(s)? | <input type="checkbox"/> Yes, no warranty; replace the cable(s). <input type="checkbox"/> No. |
| Test the six strands in the RJ12 data cable for continuity using a cable tester and inspect the cable terminals for damage. Is there an issue with the RJ12 Cable? | <input type="checkbox"/> Yes, no warranty; replace the RJ12 cable. <input type="checkbox"/> No. |

3. First power up

| Power the unit up and check | |
|--|--|
| Connect the battery monitor to a 12V power supply or a 12V battery: <ul style="list-style-type: none"> • Connect the negative to the "battery" side of the shunt. • Connect the positive to the B1 connector on the shunt. • Connect the BMV head unit via an RJ12 cable to the shunt. Does the battery monitor power up? | <input type="checkbox"/> Yes, go to step 4. <input type="checkbox"/> No. |
| Is there a DC short circuit? And if so, determine by process of elimination if the problem is caused by the head unit or the shunt board? | <input type="checkbox"/> Yes, short circuit in the head unit; lodge a warranty claim. <input type="checkbox"/> Yes, short circuit in the shunt board; lodge a warranty claim. <input type="checkbox"/> No. |
| By process of elimination, determine if the reason the battery monitor is not powering up is caused by the head unit or by the shunt board? | <input type="checkbox"/> The head unit causes the problem; lodge a warranty claim. <input type="checkbox"/> The shunt board causes the problem; lodge a warranty claim. |

4. Bluetooth

| Bluetooth check | |
|--|---|
| Is the unit a "Smart" product, i.e., does it have built-in Bluetooth? | <input type="checkbox"/> Yes. <input type="checkbox"/> No, go to step 5. |
| Is Bluetooth active, i.e., do you see the unit listed in the device list of the VictronConnect app? | <input type="checkbox"/> Yes, go to step 5. <input type="checkbox"/> No. |
| If Bluetooth is not active, it is unlikely to be a faulty Bluetooth module. More likely, Bluetooth has been turned off in the VictronConnect settings. To re-activate Bluetooth, consult the product manual. Is Bluetooth active now? | <input type="checkbox"/> Yes, go to step 5. <input type="checkbox"/> No. |
| If Bluetooth is still not active, rule out the following: <ul style="list-style-type: none"> • Are there problems with your phone or tablet? • Are you within Bluetooth range? • Just one phone or tablet can connect via Bluetooth at once. If another is connected, the unit will be listed but greyed out in VictronConnect app. • Consult the product manual and the VictronConnect manual to try to resolve the Bluetooth issue. Is Bluetooth active now? | <input type="checkbox"/> Yes. <input type="checkbox"/> No, lodge a warranty claim. |

5. Firmware and settings

| Update the firmware and reset the settings to default | |
|---|---|
| Connect via an interface (or Bluetooth) to the VictronConnect app and navigate to the unit. Is this possible? | <input type="checkbox"/> Yes. <input type="checkbox"/> No, not possible; lodge a warranty claim. |

| Update the firmware and reset the settings to default | |
|--|---|
| <p>Check if the firmware is up to date. If the firmware is not up to date, update the firmware to the most recent version using the VictronConnect app:</p> <ul style="list-style-type: none"> • Go to the VictronConnect settings page. • On the settings page, click on the "3 dots" symbol in the top right-hand corner. • Select "Product info". • On the product info page, check and/or update the firmware. | <input type="checkbox"/> Yes, the firmware has been updated. <input type="checkbox"/> Yes, the firmware was already up to date. <input type="checkbox"/> No, not possible to update the firmware. |
| <p>Save the unit's settings. File the settings under its serial number and keep the file on record for future reference. To save the settings:</p> <ul style="list-style-type: none"> • Go to the VictronConnect settings page. • On the settings page, click on the "disk" symbol at the top. | <input type="checkbox"/> Yes, the settings file has been saved. <input type="checkbox"/> No, not possible to save the settings. |
| <p>Reset all settings to default:</p> <ul style="list-style-type: none"> • Go to the VictronConnect settings page. • On the settings page, click on the "3 dots" symbol in the top right-hand corner of the page and select "Reset to defaults". | <input type="checkbox"/> Yes, the settings are set to default. <input type="checkbox"/> No, not possible to set the settings to default. |
| <p>Does the VictronConnect app display any error codes? If so, try to resolve the errors by consulting the product manual. Did it get resolved?</p> | <input type="checkbox"/> No errors, go to 6. <input type="checkbox"/> There were errors, but they were resolved. <input type="checkbox"/> There were errors, but they were not resolved. |
| <p>Write down the error number and name.</p> | <p>Error number: Error name:</p> |

6. Functionality

| Battery monitor functionality check | |
|---|---|
| <p>Measure the battery DC voltage. Compare this to the voltage indicated on the BMV head unit display or the VictronConnect app. Are they both the same (a deviation of up to 1% is allowed)?</p> | <input type="checkbox"/> Yes. <input type="checkbox"/> No, lodge warranty claim. |
| <p>Connect a DC load or charger of approximately 50A to the load side of the BMV shunt. Measure the charge current with a DC current clamp. Is the current the same as is indicated in the VictronConnect app (a deviation of up to 1% is allowed)?</p> | <input type="checkbox"/> Yes. <input type="checkbox"/> No, lodge warranty claim. |
| <p>Leave the DC charger or load connected for some time, is the "state of charge" (SoC) reading slowly changing?</p> | <input type="checkbox"/> Yes. <input type="checkbox"/> No, lodge warranty claim. |
| <p>Are all display segments functional and legible?</p> | <input type="checkbox"/> Yes. <input type="checkbox"/> No, lodge warranty claim. |
| <p>Is the display backlight functional? The backlight should turn on as soon as a button is pressed. <u>Note:</u> The display backlight can also have been turned off in the settings (setting #50). See the product manual for more information on this.</p> | <input type="checkbox"/> Yes. <input type="checkbox"/> No, lodge warranty claim. |

7. Remarks

| Provide additional fault information or add issues not already covered in earlier questions |
|---|
| |
| |
| |

Provide additional fault information or add issues not already covered in earlier questions

....

8. RMA lodgement

For your information purposes, provide details after lodging the RMA

| | |
|---------------------------|--|
| RMA type: | <input type="checkbox"/> Warranty claim. |
| | <input type="checkbox"/> Non-warranty repair or replacement request. |
| RMA lodgement date | |
| Victron Energy RMA number | |
| Your reference number | |

8. Pre-RMA test form - BatteryProtect

1. General

| Product, system and fault information | |
|--|------|
| Date | |
| Model | |
| Part number | |
| Date of installation (if known) | |
| Date of failure (if known) | |
| Battery type, brand name and overall capacity (if known) | |

2. Initial check

| Initial check | |
|---|--|
| Does the unit have mechanical damage to its housing? | <input type="checkbox"/> Yes, no warranty. <input type="checkbox"/> No. |
| Does the unit have burn marks or melting marks on its housing, or does it smell burned? | <input type="checkbox"/> Yes. <input type="checkbox"/> No. |
| Does the unit have mechanical or burn damage to its electrical connectors? | <input type="checkbox"/> Yes, no warranty. <input type="checkbox"/> No. |

3. First power up

| Power the unit up and check | |
|---|--|
| Check if the remote link is in place; if not, place the link. | <input type="checkbox"/> The link was placed. <input type="checkbox"/> The link was not placed and has now been placed. |
| Power the BatteryProtect by connecting the input terminal and the negative wire to a current limited 12 or 48V (depending on the model) power supply or battery with a DC fuse. Is there a DC shortcircuit? | <input type="checkbox"/> Yes, lodge a warranty claim. <input type="checkbox"/> No. |

4. Bluetooth

| Bluetooth check | |
|---|---|
| Is the unit a "Smart" product, i.e., does it have built-in Bluetooth? | <input type="checkbox"/> Yes. <input type="checkbox"/> No, go to step 6. |
| Is Bluetooth active, i.e., do you see the unit listed in the device list of the VictronConnect app? | <input type="checkbox"/> Yes, go to step 5. <input type="checkbox"/> No. |
| <p>If Bluetooth is not active, it is unlikely to be a faulty Bluetooth module. More likely, Bluetooth has been turned off in the VictronConnect settings.</p> <p>To re-activate Bluetooth:</p> <ul style="list-style-type: none"> • Program the BatteryProtect to the "h" setting via its "PROG" terminal. For more information, see the product manual. <p>Is Bluetooth active now?</p> | <input type="checkbox"/> Yes, go to step 5. <input type="checkbox"/> No. |

| Bluetooth check | |
|--|---|
| <p>If Bluetooth is still not active, rule out the following:</p> <ul style="list-style-type: none"> • Are there problems with your phone or tablet? • Are you within Bluetooth range? • Just one phone or tablet can connect via Bluetooth at once. If another is connected, the unit will be listed but greyed out in VictronConnect app. • Consult the product manual and the VictronConnect manual to try to resolve the Bluetooth issue. <p>Is Bluetooth active now?</p> | <input type="checkbox"/> Yes. <input type="checkbox"/> No, lodge a warranty claim. |

5. Firmware

| Update the firmware | |
|--|---|
| <p>Connect via Bluetooth to the VictronConnect app and navigate to the unit. Is this possible?</p> <p>In case the PIN code is unknown, reset the PIN code, using the PUK code. For information on how to do this, see the VictronConnect manual.</p> | <input type="checkbox"/> Yes. <input type="checkbox"/> No, not possible; lodge a warranty claim. |
| <p>Check if the firmware is up to date. If the firmware is not up to date, update the firmware to the most recent version using the VictronConnect app:</p> <ul style="list-style-type: none"> • Go to the VictronConnect settings page. • On the settings page, click on the "3 dots" symbol in the top right-hand corner. • Select "Product info". • On the product info page, check and/or update the firmware. | <input type="checkbox"/> Yes, the firmware has been updated. <input type="checkbox"/> Yes, the firmware was already up to date. <input type="checkbox"/> No, not possible to update the firmware. |

6. Functionality

| BatteryProtect functionality check | |
|---|---|
| <p>Does the BatteryProtect display any errors? If so, try to resolve the errors by consulting the product manual.</p> <p>Did it get resolved?</p> | <input type="checkbox"/> No errors. <input type="checkbox"/> There were errors, but they were resolved. <input type="checkbox"/> There were errors, but they were not resolved. |
| <p>Write down the error number and name.</p> | <input type="checkbox"/> No errors. Error number: Error name: |
| <p>Program the BatteryProtect to setting "P1".</p> | <input type="checkbox"/> Done. |
| <p>Measure the output voltage. Is this voltage the same as the supply voltage?</p> | <input type="checkbox"/> Yes. <input type="checkbox"/> No, lodge a warranty claim. |
| <p>Decrease the input voltage to 9, 18 or 36V (depending on the model). Does the output turn off after 90 seconds?</p> | <input type="checkbox"/> Yes. <input type="checkbox"/> No, lodge a warranty claim. |
| <p>Increase the input voltage to 13.5, 27 or 54V (depending on the model). Does the output turn back on?</p> | <input type="checkbox"/> Yes. <input type="checkbox"/> No, lodge a warranty claim. |
| <p>Increase the input voltage to 16, 32 or 64V (depending on the model). Does the output turn off?</p> | <input type="checkbox"/> Yes. <input type="checkbox"/> No, lodge a warranty claim. |

BatteryProtect functionality check

Decrease the input voltage to 12, 24 or 48V (depending on the model). Does the output turn back on?

- Yes.
 No, lodge a warranty claim.

Remote check

Remove the wire link, does the BatteryProtect turn off?

- Yes,
 No, lodge warranty claim.

With the wire link removed, connect the L terminal to the negative of the DC supply. Does the BatteryProtect turn on?

Refer to the product manual to locate the L terminal.

- Yes,
 No, lodge warranty claim.

With the wire link removed, connect the H terminal to the positive of the DC supply. Does the BatteryProtect turn on?

Refer to the product manual to locate the H terminal.

- Yes,
 No, lodge warranty claim.

7. Remarks**Provide additional fault information or add issues not already covered in earlier questions**

....

....

....

....

8. RMA lodgement**For your information purposes, provide details after lodging the RMA**

RMA type:

- Warranty claim.
 Non-warranty repair or replacement request.

RMA lodgement date

....

Victron Energy RMA number

....

Your reference number

....

9. Pre-RMA test form - Orion-Tr DC-DC converter

1. General

| Product, system and fault information | |
|--|------|
| Date | |
| Model | |
| Part number | |
| Date of installation (if known) | |
| Date of failure (if known) | |
| Battery type, brand name and overall capacity (if known) | |

2. Initial check

Table 1.

| Initial check | |
|--|--|
| Does the unit have mechanical damage to its housing? | <input type="checkbox"/> Yes, no warranty. <input type="checkbox"/> No. |
| Does the unit have burn marks or melting marks on its housing, or does it smell burned? | <input type="checkbox"/> Yes. <input type="checkbox"/> No. |
| <div style="border: 1px solid #0070C0; border-radius: 5px; padding: 5px; display: inline-block;">  The potting used in the Orion may emit a slight odour, but this is not a cause for concern. </div> | |
| Does the unit have mechanical or burn damage to its electrical connectors? | <input type="checkbox"/> Yes, no warranty. <input type="checkbox"/> No. |

3. First power up

| Power the unit up and check | |
|---|---|
| <p><u>For models with a remote link only:</u> Check if the remote link is in place; if not, place the link. <u>Note:</u> To find the location of the remote link, refer to the product manual.</p> | <input type="checkbox"/> The link was placed. <input type="checkbox"/> The link was not placed and has now been placed. |
| <p>Connect the input terminals to a current limited 12, 24 or 48V power supply (depending on the model) or a battery with a DC fuse. Is there a DC short circuit?</p> <div style="border: 1px solid #0070C0; border-radius: 5px; padding: 5px; display: inline-block;">  Instead of a power supply, you can also use a multimeter to check for a short circuit. </div> <p><u>Background information:</u> A DC short circuit nearly always indicates that the DC-DC converter has been connected to reverse battery polarity. Reverse battery polarity is not covered under warranty.</p> | <input type="checkbox"/> No. <input type="checkbox"/> Yes, and there was reverse battery polarity; no warranty. <input type="checkbox"/> Yes, and there was no reverse battery polarity; lodge a warranty claim. |
| <p><u>For DC-DC converters with an external fuse:</u> Remove the fuse and check the fuse for continuity. If the fuse is broken, replace the fuse. What is the outcome?</p> <p><u>Background information:</u> If the replacement fuse blows, the DC-DC converter has a short circuit; this is nearly always an indication that the DC-DC converter has been connected to reverse battery polarity. Reverse battery polarity is not covered under warranty.</p> | <input type="checkbox"/> The fuse is not broken. <input type="checkbox"/> The replacement fuse blew, and there was reverse battery polarity; no warranty. <input type="checkbox"/> The replacement fuse blew, and there was no reverse polarity; lodge a warranty claim. <input type="checkbox"/> The fuse was broken and has been replaced. |

4. Bluetooth



| Bluetooth check | |
|---|---|
| Is the unit a "Smart" product, i.e., does it have built-in Bluetooth? | <input type="checkbox"/> Yes. <input type="checkbox"/> No, go to step 6. |
| Is Bluetooth active, i.e., do you see the unit listed in the device list of the VictronConnect app? | <input type="checkbox"/> Yes, go to step 5. <input type="checkbox"/> No. |
| <p>If Bluetooth is not active, it is unlikely to be a faulty Bluetooth module. More likely, Bluetooth has been turned off in the VictronConnect settings.</p> <p>To re-activate Bluetooth:</p> <ul style="list-style-type: none"> In the unit's VictronConnect app "product info" page, three options are available for Bluetooth behaviour: <ul style="list-style-type: none"> Bluetooth enabled. Bluetooth enabled for 30 seconds. Bluetooth disabled. If the "Bluetooth enabled for 30 seconds" option was chosen, you can re-activate Bluetooth by unpowering and repowering the unit, then navigating to the unit's product settings to re-enable Bluetooth. However, if the "Bluetooth disabled" option was chosen, it is not possible to re-activate Bluetooth. <p>Is Bluetooth active now?</p> | <input type="checkbox"/> Yes, go to step 5. <input type="checkbox"/> No. |
| <p>If Bluetooth is still not active, rule out the following:</p> <ul style="list-style-type: none"> Are there problems with your phone or tablet? Are you within Bluetooth range? Just one phone or tablet can connect via Bluetooth at once. If another is connected, the unit will be listed but greyed out in VictronConnect app. Consult the product manual and the VictronConnect manual to try to resolve the Bluetooth issue. <p>Is Bluetooth active now?</p> | <input type="checkbox"/> Yes. <input type="checkbox"/> No, lodge a warranty claim. |

5. Firmware and settings

| Update the firmware and reset the settings to default | |
|--|---|
| <p>Use the VictronConnect app and select the unit in the device list. Is this possible?</p> <p>In case the PIN code is unknown, reset the PIN code, using the PUK code. For information on how to do this, see the VictronConnect manual.</p> | <input type="checkbox"/> Yes. <input type="checkbox"/> No, not possible; lodge a warranty claim. |
| <p>Check if the firmware is up to date. If the firmware is not up to date, update the firmware to the most recent version using the VictronConnect app:</p> <ul style="list-style-type: none"> Go to the VictronConnect settings page. On the settings page, click on the "3 dots" symbol in the top right-hand corner. Select "Product info". On the product info page, check and/or update the firmware. | <input type="checkbox"/> Yes, the firmware has been updated. <input type="checkbox"/> Yes, the firmware was already up to date. <input type="checkbox"/> No, not possible to update the firmware. |
| <p>Save the unit's settings. File the settings under its serial number and keep the file on record for future reference. To save the settings:</p> <ul style="list-style-type: none"> Go to the VictronConnect settings page. On the settings page, click on the "disk" symbol at the top. | <input type="checkbox"/> Yes, the settings file has been saved. <input type="checkbox"/> No, not possible to save the settings. |

| Update the firmware and reset the settings to default | |
|---|--|
| Reset all settings to default: <ul style="list-style-type: none"> Go to the VictronConnect settings page. On the settings page, click on the "3 dots" symbol in the top right-hand corner of the page and select "Reset to defaults". | <input type="checkbox"/> Yes, the settings are set to default. <input type="checkbox"/> No, not possible to set the settings to default. |
| Does the VictronConnect app display any error codes? If so, try to resolve the errors by consulting the product manual. Did it get resolved? | <input type="checkbox"/> No errors, go to 6. <input type="checkbox"/> There were errors, but they were resolved. <input type="checkbox"/> There were errors, but they were not resolved. |
| Write down the error number and name. | Error number: Error name: |

6. Functionality

| DC-DC converter functional check | |
|--|---|
| Measure the voltage on the output terminals. Do you measure a voltage higher than 10, 20 or 40V (depending on the model)? <div style="border: 1px solid #0070C0; border-radius: 10px; padding: 5px; margin-top: 10px;">  <p>When the "Engine shutdown detection" feature is enabled, the input voltage must be at least 14, 28, or 56V for the output to be enabled.</p> </div> | <input type="checkbox"/> Yes. <input type="checkbox"/> No, lodge a warranty claim. |
| <u>For models with a voltage adjustment screw only:</u> Measure the voltage on the output terminals. Turn the screw. Is the output voltage decreasing when turning to the left and is it increasing when turning to the right? | <input type="checkbox"/> Yes. <input type="checkbox"/> No, lodge a warranty claim. |
| <u>For Smart models only:</u> Measure the voltage on the input terminals. Compare this to the input voltage as indicated in the VictronConnect app. Are they both the same (a deviation of up to 1% is allowed)? | <input type="checkbox"/> Yes. <input type="checkbox"/> No, lodge a warranty claim. |
| <u>For Smart models only:</u> Measure the voltage on the output terminals. Compare this to the output voltage as indicated in the VictronConnect app. Are they both the same (a deviation of up to 1% is allowed)? | <input type="checkbox"/> Yes. <input type="checkbox"/> No, lodge a warranty claim. |
| Connect a DC load to the output of the DC-DC converter. Can the DC-DC converter deliver its maximum rated power to the DC load? | <input type="checkbox"/> Yes. <input type="checkbox"/> No, lodge a warranty claim. |
| Connect an empty battery to the output terminals. Does the DC-DC converter charge the battery? <div style="border: 1px solid #0070C0; border-radius: 10px; padding: 5px; margin-top: 10px;">  <p>For battery charging to occur, the battery voltage must be lower than the output voltage of the DC-DC converter. Charging happens when current flows from the DC-DC converter to the battery. You can verify this by using a DC current clamp. Please note that the charge voltage may take some time to rise after power-up.</p> </div> | <input type="checkbox"/> Yes. <input type="checkbox"/> No, lodge a warranty claim. |

7. Remarks

| Provide additional fault information or add issues not already covered in earlier questions |
|---|
| |
| |
| |

Provide additional fault information or add issues not already covered in earlier questions

....

8. RMA lodgement

For your information purposes, provide details after lodging the RMA

| | |
|---------------------------|--|
| RMA type: | <input type="checkbox"/> Warranty claim. <input type="checkbox"/> Non-warranty repair or replacement request. |
| RMA lodgement date | |
| Victron Energy RMA number | |
| Your reference number | |

10. Pre-RMA test form - Lead-acid battery

1. General

| Product, system and fault information | |
|--|---|
| Date | |
| Model | |
| Part number | |
| Date of installation (if known) | |
| Date of failure (if known) | |
| Does the battery bank consist of an individual battery or multiple batteries? | <input type="checkbox"/> Multiple batteries. <input type="checkbox"/> Individual battery, go to 2. |
| How many batteries are connected in series? | |
| How many batteries or series strings are connected in parallel? | |
| Inspect the battery bank or ask for a photo of the battery bank showing the battery bank wiring. Is the battery bank wired conform to chapter 3 in the Wiring unlimited book ? | <input type="checkbox"/> Yes. <input type="checkbox"/> No, no warranty. |
| Are all batteries in the battery bank the same model, age and capacity? | <input type="checkbox"/> Yes. <input type="checkbox"/> No, no warranty. |

2. Initial check

| visual check | |
|---|--|
| Is the battery case damaged? | <input type="checkbox"/> Yes, no warranty. <input type="checkbox"/> No. |
| Is the battery leaking acid? | <input type="checkbox"/> Yes, no warranty. <input type="checkbox"/> No. |
| Is the battery case swollen or deformed? | <input type="checkbox"/> Yes, no warranty. <input type="checkbox"/> No. |
| Does the battery weigh a few kilos less than its weight as listed in its datasheet? | <input type="checkbox"/> Yes, no warranty. <input type="checkbox"/> No. |
| Are the battery terminals damaged, badly corroded or have significant burn marks? | <input type="checkbox"/> Yes, no warranty. <input type="checkbox"/> No. |

3. Battery usage check

| Battery usage check | |
|---|---|
| <p>Does the installation contain a battery monitor with a history menu, like a BMV or SmartShunt and/or is the system on the VRM portal?</p> <p>If a battery monitor is present, use its history information to check the below items. Alternatively, check the VRM portal, or talk to the end-user of the battery.</p> | <input type="checkbox"/> The system has a battery monitor. <input type="checkbox"/> The system is on the VRM portal. <input type="checkbox"/> No battery monitor or on VRM. |

| Battery usage check | |
|--|---|
| <p>Deepest discharge and the time since last full charge:</p> <p>Has the battery been too deeply discharged and left for a few days in a deeply discharged state?</p> <p><u>Background:</u> an occasional deep discharge is not ideal but will not necessarily damage a battery. However, a battery will sustain unrecoverable damage if it is left in a deeply discharged state for more than a few days. This damage is not covered under warranty.</p> | <input type="checkbox"/> Yes, no warranty. <input type="checkbox"/> No. <input type="checkbox"/> Unknown. |
| <p>Average discharge:</p> <p>Has the battery, on average, been too deeply discharged, well below 50% state of charge?</p> <p><u>Background:</u> Generally speaking, a lead-acid battery should not be discharged deeper than 50% of its rated battery capacity. Regularly deeply discharging a battery will significantly reduce its lifetime and damage the battery. This damage is not covered under warranty.</p> | <input type="checkbox"/> Yes, no warranty. <input type="checkbox"/> No. <input type="checkbox"/> Unknown. |
| <p>Cumulative Ah drawn:</p> <p>Is the battery at the end of its lifetime? Has it produced more energy than what it has been designed for? Does the "Cumulative Ah drawn" parameter in the battery monitor history divided by the rated battery capacity exceed the battery's cycle life as listed in the datasheet?</p> <p><u>Background:</u> A battery is a consumable, it will wear out over time, and it will eventually need to be replaced when it has reached the end of its life. This is not covered under warranty.</p> | <input type="checkbox"/> Yes, no warranty. <input type="checkbox"/> No. <input type="checkbox"/> Unknown. |
| <p>Total charge cycles in relation to average discharge:</p> <p>Is the battery at the end of its lifetime? Has it exceeded its designed cycle life? Does the "Total charge cycle" parameter in the battery monitor history exceed the battery's cycle life as listed in the datasheet while considering the average discharge?</p> <p><u>Background:</u> A battery is a consumable, it will wear out over time, and it will eventually need to be replaced once it has reached the end of its life. The deeper the average discharge, the shorter its cycle life will be. This is not covered under warranty.</p> | <input type="checkbox"/> Yes, no warranty. <input type="checkbox"/> No. <input type="checkbox"/> Unknown. |
| <p>Synchronisations in relation to total charge cycles:</p> <p>Has the battery not always been fully charged? For example, the charger never reaches the float cycle, such as when there is not enough solar energy (winter) to charge the battery fully or when a generator is turned off before the charger has reached the float stage. Compare the battery monitor history "Synchronisations" and "Charge cycle" parameters. Is there a significant difference?</p> <p><u>Background:</u> A full charge is when the battery charger has reached the float stage. This can be checked by looking at the total charge cycles compared to the synchronisations. The battery monitor is synchronised each time the battery has been fully charged. If there is a big difference between the charge cycles and the synchronisations, this can indicate that the battery has not always been fully charged. Repeatedly not fully charging a battery will lead to battery damage and a reduced lifetime. However, do note that a difference between synchronisations and charge cycles can also have been caused by an incorrect configuration of the battery monitor.</p> | <input type="checkbox"/> Yes, no warranty. <input type="checkbox"/> No. <input type="checkbox"/> Unknown. |
| <p>The number of full discharges:</p> <p>Has the battery often been very deeply discharged? Are there more than 25 full discharges in the battery monitor history?</p> <p><u>Background:</u> Habitually deeply discharging the battery will cause irreversible damage, and this damage is not covered under warranty.</p> | <input type="checkbox"/> Yes, no warranty. <input type="checkbox"/> No. <input type="checkbox"/> Unknown. |

Battery usage check**Maximum battery voltage:**

Has the battery voltage been above 15V? For example, due to a faulty or incorrectly configured battery charger?

Background: A too high battery voltage will cause gassing in the battery, and if this is not stopped in time, this gas will escape via the battery emergency vent. The battery weight will reduce, or in a severe case, the battery case might swell up. The battery will sustain irreversible damage, and this damage is not covered under warranty.

- Yes, no warranty.
- No.
- Unknown.

4. Functionality**Battery terminal voltage check**

Remove the battery from the battery bank. Measure its terminal voltage and write it down.

Battery voltage:

Charge the battery with a 3-stage charger. Ensure that the charger is set to the following:

- Absorption voltage 14.2V.
- Float voltage 13.5V.
- Charge current 0.1C (Example for a 100Ah battery: 0.1 x 100Ah =10A charge current).

- Yes.
- No, the battery is faulty.

Charge the battery until the battery charger has reached the float stage. (This can take up to 10 hours). Did the charger reach the float stage?

Disconnect the charger. Let the battery rest for 4 to 5 hours. Measure the battery voltage again and write it down.

Resting battery voltage:

Is the battery voltage significantly below 12.6 V?

- Yes, the battery is faulty.
- No.

Battery capacity check

Note that Victron AGM and GEL batteries are deep cycle batteries and cannot be tested using hand-held battery testers. The only way to test the capacity of a deep cycle battery is first to charge the battery, then discharge it in a controlled manner and then calculate the battery capacity.

Start with a fully charged battery. Connect a DC load (no bigger than 0.1C) to the battery. This can be a DC load bank, DC incandescent light globes or an inverter running a constant AC load. Turn the load on and write down the time.

Start time:

Measure and write down the DC current.

DC current:

Monitor the battery voltage. As soon as the voltage drops below 12V, turn the load off and write down the time.

End time:

How long was the total time?

Total time:

Calculate the battery capacity in Ah. Multiply the DC current (A) with the total time (h).

Calculated battery capacity:

Is the calculated battery capacity at least 75% of the rated battery capacity?

- Yes.
- No, the battery is faulty.

5. Remarks**Provide additional fault information or add issues not already covered in earlier questions**

....

....

....

Provide additional fault information or add issues not already covered in earlier questions

....

6. RMA lodgement

For your information purposes, provide details after lodging the RMA





| | |
|---------------------------|--|
| RMA type: | <input type="checkbox"/> Warranty claim. |
| | <input type="checkbox"/> Non-warranty repair or replacement request. |
| RMA lodgement date | |
| Victron Energy RMA number | |
| Your reference number | |



11. Pre-RMA test form - Lithium Battery Smart

1. General





| Product, system and fault information | |
|--|---|
| Date | |
| Model | |
| Part number | |
| Date of installation (if known) | |
| Date of failure (if known) | |
| BMS model used | |
| VRM portal ID | |
| Does the battery bank consist of an individual battery or multiple batteries? | <input type="checkbox"/> Multiple batteries. <input type="checkbox"/> Individual battery, go to section 2. |
| How many batteries are connected in series? | |
| How many batteries or series strings are connected in parallel? | |
| Check the battery bank or request a photo of its wiring. Is the wiring conform chapter 3 in the Wiring unlimited book ? | <input type="checkbox"/> Yes. <input type="checkbox"/> No, no warranty. |
| Are all batteries in the battery bank the same model, age and capacity? Note that this does not apply to the exceptions as described in the electric installation chapter in the manual . | <input type="checkbox"/> Yes. <input type="checkbox"/> No, no warranty. |

2. Initial check

| visual check | |
|--|--|
| Is there mechanical damage to the battery case? <div style="border: 1px solid #0070C0; padding: 5px; margin-bottom: 10px;">  The warranty excludes battery damage from dropping, transportation, installation, or external causes. </div> | <input type="checkbox"/> Yes, no warranty. <input type="checkbox"/> No. |
| Did any material leak from the case, or is the case damaged, expanded, warped, or melted? <div style="border: 1px solid #0070C0; padding: 5px; margin-bottom: 10px;">  This indicates that the battery was either overcharged, charged at temperatures below 5 °C, or deeply discharged, followed by an unmonitored recharge. </div> | <input type="checkbox"/> Yes, no warranty. <input type="checkbox"/> No. |
| Are there signs of water ingress into the battery case? <div style="border: 1px solid #0070C0; padding: 5px; margin-bottom: 10px;">  The battery has an IP22 rating and is not waterproof. </div> | <input type="checkbox"/> Yes, no warranty. <input type="checkbox"/> No. |
| Is there damage to the BMS cables or its connectors? <div style="border: 1px solid #0070C0; padding: 5px; margin-bottom: 10px;">  Possible causes are: <ul style="list-style-type: none"> BMS cables subjected to excessive pulling or used for battery lifting. Connectors crushed beneath or caught between adjacent batteries. </div> | <input type="checkbox"/> Yes, no warranty. <input type="checkbox"/> No. |

| visual check | |
|--|--|
| <p>Have the cells or busbars inside the battery moved, or are they damaged?</p> <div style="border: 1px solid #0070C0; padding: 5px; margin-top: 10px;"> <p> The battery can only be used upright. Sideways use, especially in vibrating environments (vehicle or boat), can result in cell or busbar misalignment. Request an installation photo.</p> </div> | <input type="checkbox"/> Yes, no warranty. <input type="checkbox"/> No. |
| <p>Are the battery terminals damaged, badly corroded, or have significant burn marks?</p> <div style="border: 1px solid #0070C0; padding: 5px; margin-top: 10px;"> <p> This can be caused by exceeding the maximum torque or arcing during an electrical connection.</p> </div> | <input type="checkbox"/> Yes, no warranty. <input type="checkbox"/> No. |

3. Battery usage check

| Battery usage check | |
|---|---|
| <p>Is the BMS working and installed correctly? Discuss with the end user or get an installation schematic.</p> <div style="border: 1px solid #0070C0; padding: 5px; margin-top: 10px;"> <p> To check BMS functionality, refer to the "How to test if the BMS is functional" chapter in the manual.</p> </div> | <input type="checkbox"/> Yes <input type="checkbox"/> No, no warranty <input type="checkbox"/> Unknown |
| <p>Does the installation contain a battery monitor with a history menu, like a BMV, SmartShunt or Lynx Smart BMS and/or is the system on the VRM portal?</p> | <input type="checkbox"/> The system has a battery monitor. <input type="checkbox"/> The system is on the VRM portal. <input type="checkbox"/> No battery monitor or on VRM. |
| <p>Has the battery been too deeply discharged and left for a few months in a deeply discharged state? Check this on the VRM portal or inquire with the end user.</p> <div style="border: 1px solid #0070C0; padding: 5px; margin-top: 10px;"> <p> Extended deep discharge, like during winter storage for boats or vehicles, can lead to irreversible cell damage.</p> </div> | <input type="checkbox"/> Yes, no warranty. <input type="checkbox"/> No. <input type="checkbox"/> Unknown. |
| <p>Is the battery past its lifespan? Has it produced more energy than what it has been designed for? Divide the "Cumulative Ah drawn" history parameter by the rated battery capacity. Does it surpass the battery's cycle life in the datasheet?</p> <div style="border: 1px solid #0070C0; padding: 5px; margin-top: 10px;"> <p> A battery is a consumable; it wears out with time and needs replacing when its life ends.</p> </div> | <input type="checkbox"/> Yes, no warranty. <input type="checkbox"/> No. <input type="checkbox"/> Unknown. |
| <p>Has the battery received a monthly full charge, i.e. reached the "float" stage? Check this on the VRM portal or inquire with the end user.</p> <div style="border: 1px solid #0070C0; padding: 5px; margin-top: 10px;"> <p> Cell balancing occurs in the absorption charge phase, when the battery voltage exceeds 14.2V (28.4V). Interrupting this stage and not arriving at the float stage leads to incomplete balancing and potential cell damage. Lithium batteries should be fully charged once a month.</p> </div> | <input type="checkbox"/> Yes. <input type="checkbox"/> No, no warranty. <input type="checkbox"/> Unknown. |
| <p>Has the battery voltage been above 15V (30V)? Check this in the battery monitor history or on the VRM portal.</p> <div style="border: 1px solid #0070C0; padding: 5px; margin-top: 10px;"> <p> This happens due to a faulty charger, misconfigured charger, the wrong type of charger, BMS problems or the BMS is not controlling all charge sources. Excessive voltage harms cells, causing swelling, material leakage, or smoke release in extreme cases.</p> </div> | <input type="checkbox"/> Yes, no warranty. <input type="checkbox"/> No. <input type="checkbox"/> Unknown. |

Battery usage check

Was the battery temperature above 50°C or below 5°C during charging?
Check this on the VRM portal.



This can only happen if there are problems with the BMS or the BMS does not control all charge sources.

- Yes, no warranty.
- No.
- Unknown.

4. Initial voltage check**Initial voltage check**

Measure the battery terminal voltage and write it down.

.....

Is the voltage above 10V (20V)?



Bluetooth will not be active when the battery voltage is below 8V (16V) or if a cell is below 2V.

- Yes, go to section 5.
- No, no warranty.

Is the voltage below 8V for a 12.8V model or 16V for a 25.6V model?



While recharging might work, the battery is damaged with capacity loss. A terminal voltage <10V (<20V) or cell voltage <2.6V is not covered by warranty.

- Yes, no warranty.
An attempt can be made to recover the battery; refer to the "[Micro-controller power-cycle procedure](#)" in the manual.
- No, no warranty.
An attempt can be made to recover the battery; refer to the "[Battery very low terminal voltage](#)" chapter in the manual.

5. Bluetooth**Bluetooth check**

Is Bluetooth active, i.e., do you see the unit in the device list of the VictronConnect app?

- Yes, go to section 6.
- No.

Exclude these factors and address them if relevant:

- Are there problems with your phone or tablet?
- Are you within Bluetooth range?
- Just one phone or tablet can connect via Bluetooth at once. If another is connected, the unit will be listed but greyed out in VictronConnect app.
- Consult the product manual and the [VictronConnect manual](#) to try to resolve the Bluetooth issue.

- Yes, go to section 6
- No.

Is Bluetooth active now?

Open the battery, measure each cell voltage, and write them down.

Cell 1: Cell 2: Cell 3: Cell 4:
(Cell 5: Cell 6: Cell 7: Cell 8:)

Are any of the cells below 2V?

- Yes, no warranty.
- No.

Bluetooth might have been turned off in the product settings, or the Bluetooth module failed to power up correctly.

Perform the [Micro-controller power-cycle procedure](#) located in the appendix of the manual.

Is Bluetooth active now?

- Yes, go to section 6.
- No, lodge RMA and ask for a new circuit board.

6. Functionality

| Functionality check | |
|---|---|
| Measure the terminal voltage. Is it at least 12.8V (25.6)? If not, charge the battery until the terminal voltage is at least 12.8V (25.6V). | <input type="checkbox"/> Yes, the terminal voltage is above 12.8V (25.6V). <input type="checkbox"/> No, not possible, no warranty. |
| Update the firmware and set all settings to default. | <input type="checkbox"/> Done <input type="checkbox"/> Was not possible. |
| Connect the battery to a BMS. Is the BMS indicating a pre-alarm, low-voltage or high-voltage alarm? If so, replace the PCB or lodge an RMA. Is the BMS showing any alarms? | <input type="checkbox"/> No. <input type="checkbox"/> Yes, lodge an RMA. |
| Connect with the VictronConnect app and write down the individual cell voltages: Cell 1: Cell 2: Cell 3: Cell 4: (Cell 5: Cell 6: Cell 7: Cell 8:) Are any of the cells below 2V? | <input type="checkbox"/> Yes, no warranty. <input type="checkbox"/> No. |
| Does the VictronConnect app indicate that the cells are balanced? | <input type="checkbox"/> Yes, skip the next step. <input type="checkbox"/> No. |
| Charge the battery using the information in the " cell imbalance " chapter in the manual. Write down the individual cell voltages: Cell 1: Cell 2: Cell 3: Cell 4: (Cell 5: Cell 6: Cell 7: Cell 8:) Are the cells balanced now? | <input type="checkbox"/> Yes. <input type="checkbox"/> No, the battery is faulty. |
| Disconnect the charger. Let the battery rest for a day. After a day, check the cell voltages and write them down: Cell 1: Cell 2: Cell 3: Cell 4: (Cell 5: Cell 6: Cell 7: Cell 8:) Is the battery still balanced? | <input type="checkbox"/> Yes. <input type="checkbox"/> No, no warranty. |
| Is the battery voltage significantly below 12.8 V? | <input type="checkbox"/> Yes, no warranty. <input type="checkbox"/> No. |
| Discharge the battery until 11V (22V). Recharge the battery using a BlueSmart battery charger in "lithium" mode with absorption set at 14.2V (28.4) and float at 13.5V (27V). Charge until the charger goes to float. Look at the charger history and check how much capacity (Ah) went into the battery. Is there a big difference in the battery's rated capacity (Ah) compared to what the charger supplied? | <input type="checkbox"/> Yes, no warranty. <input type="checkbox"/> No, the battery is okay. |

7. Remarks

| Provide additional fault information or add issues not already covered in earlier questions |
|---|
| |
| |
| |
| |

8. RMA lodgement

| For your information purposes, provide details after lodging the RMA | |
|--|--|
| RMA type: | <input type="checkbox"/> Warranty claim. <input type="checkbox"/> Non-warranty repair or replacement request. |
| RMA lodgement date | |
| Victron Energy RMA number | |
| Your reference number | |