



 **FLEXpower ONE**
Installation Manual



About OutBack Power Systems

OutBack Power Systems is a leader in advanced energy conversion technology. Our products include true sine wave inverter/chargers, maximum power point charge controllers, system communication components, as well as breaker panels, breakers, accessories, and assembled systems.

Contact Information

Telephone: +1.360.435.6030 (North America) +34.93.654.9568 (Barcelona, Spain)
+1.360.618.4363 (Technical Support)
+1.360.435.6019 (Fax)

Address: North America
19009 62nd Avenue NE
Arlington, WA USA

E-mail: Support@outbackpower.com

Web Site: www.outbackpower.com

Disclaimer

UNLESS SPECIFICALLY AGREED TO IN WRITING, OUTBACK POWER SYSTEMS:

(a) MAKES NO WARRANTY AS TO THE ACCURACY, SUFFICIENCY OR SUITABILITY OF ANY TECHNICAL OR OTHER INFORMATION PROVIDED IN ITS MANUALS OR OTHER DOCUMENTATION.

(b) ASSUMES NO RESPONSIBILITY OR LIABILITY FOR LOSS OR DAMAGE, WHETHER DIRECT, INDIRECT, CONSEQUENTIAL OR INCIDENTAL, WHICH MIGHT ARISE OUT OF THE USE OF SUCH INFORMATION. THE USE OF ANY SUCH INFORMATION WILL BE ENTIRELY AT THE USER'S RISK.

Warranty Summary

OutBack Power Systems Inc. warrants that the products it manufactures will be free from defects in materials and workmanship for a period of five (5) years subject to the conditions set forth in the warranty detail found inside the back cover of this manual.

OutBack Power Systems cannot be responsible for system failure, damages, or injury resulting from improper installation of their products.

Notice of Copyright

FLEXpower ONE™ Installation Manual ©October 2009 by OutBack Power Systems. All Rights Reserved.

Trademarks

FLEXpower ONE is a registered trademark of OutBack Power Systems. OutBack Power is a registered trademark of OutBack Power Systems.

Date and Revision

October 2009, Revision A

Part Number





900-0095-01-00 Rev A

Important Safety Instructions

READ AND SAVE THESE INSTRUCTIONS!

This manual contains important safety instructions for the FLEXpower ONE. Read all instructions and cautionary markings on the FLEXpower ONE and on any accessories or additional equipment included in the installation. Failure to adhere to these instructions could result in severe shock or possible electrocution. Exercise extreme caution at all times to prevent accidents.

Symbols Used

Symbol	Description
	Ground
	AC Current
	DC Current
	Single-Phase
	Sine Wave



WARNING: Hazard to Human Life

This type of notation indicates that the hazard could be harmful to human life.



CAUTION: Hazard to Equipment

This type of notation indicates that the hazard may cause damage to the equipment.



IMPORTANT:

This type of notation indicates that the information provided is important to the installation, operation and/or maintenance of the equipment. Failure to follow the recommendations in such a notation could result in voiding the equipment warranty.

Audience

These instructions are for use by qualified personnel who meet all local and governmental code requirements for licensing and training for the installation of electrical power systems with AC and DC voltage up to 240 Vac and 150 Vdc.

Definitions

- **Off-Grid** – Utility Grid Power *is not* available for use.
- **On-Grid** – Utility Grid power *is* available for use. *Does not imply the ability to sell power back to the utility grid.*
- **Grid-tie, Grid-interactive, Grid-intertie** – Utility Grid Power is available for use and the system is capable of returning (selling) electricity back to the utility grid.

Table 1 Acronyms

Acronym	Definition
AC	Alternating Current
ANSI	American National Standards Institute
DC	Direct Current
FCC	Federal Communications Commission (North America)
GND	Ground
IEEE	Institute of Electrical and Electronics Engineers
N	AC Neutral
NEC	National Electric Code (North America)
NFPA	National Fire Protection Association
OSHA	Occupational Safety and Health Association
PV	Photovoltaic
RE	Renewable Energy
UL	Underwriters Laboratory

General Safety



WARNING: Limitations on Use

This equipment is NOT intended for use with life support equipment or other medical equipment or devices.



CAUTION: Equipment Damage

Only use components or accessories recommended or sold by OutBack Power Systems or its authorized agents.





IMPORTANT:

Do not attempt to install this equipment if it appears to be damaged in any way. See the Troubleshooting Section for instructions on how to return the equipment if you know, or suspect, it is damaged.

Personal Safety

	<p>WARNING: Personal Injury</p> <ul style="list-style-type: none"> ➤ This equipment weighs approximately 98 lbs (44.5 kg). Use safe lifting techniques when lifting this equipment as prescribed by the Occupational Safety and Health Association (OSHA) or other local codes. ➤ Use standard safety equipment such as safety glasses, ear protection, steel-toed safety boots, safety hard hats, etc. as prescribed by the Occupational Safety and Health Association (or other local codes) when working on this equipment. ➤ Use standard safety practices when working with electrical equipment (e.g., remove all jewelry, use insulated tools, wear cotton clothing, etc.) ➤ Never work alone when installing or servicing this equipment. Have someone nearby that can come to your aid if necessary.
---	--

FLEXpower ONE System Safety

	<p>WARNING: Lethal Voltage</p> <ul style="list-style-type: none"> ➤ Review the system configuration to identify all possible sources of energy. Ensure ALL sources of power are disconnected before performing any installation or maintenance on this equipment. Confirm that the terminals are de-energized using a validated voltmeter (rated for a minimum 1000 Vac and 1000 Vdc) to verify the de-energized condition. ➤ Do not perform any servicing other than that specified in the installation instructions unless qualified to do so or as instructed to do so by OutBack Power Systems Technical Support personnel.
	<p>WARNING: Burn Hazard</p> <p>Internal parts can become hot during operation. Do not remove the cover during operation or touch any internal parts. Be sure to allow them sufficient time to cool down before attempting to perform any maintenance.</p>
	<p>WARNING: Fire Hazard</p> <ul style="list-style-type: none"> ➤ In residential installations: check for multi-wire branch circuit wiring at the location for the installation. A possible fire hazard can exist if 120 Vac only sources (such as inverters and generators) are wired incorrectly into 120/240 Vac panels containing multi-wire branch circuits. Consult the local electric code for assistance. ➤ Do not place combustible or flammable materials within 12 feet (3.7 m) of the equipment. ➤ Use only the recommended cable sizes (or greater) for AC and DC conductors in compliance with local codes. Ensure all conductors and connections are in good condition. Do not operate the unit with damaged or substandard cabling.



CAUTION: Equipment Damage

- When connecting cables from the inverter to the battery terminals, ensure the proper polarity is observed. Connecting the cables incorrectly can damage or destroy the equipment.
- Thoroughly inspect the equipment prior to energizing. Verify that no tools or equipment have been inadvertently left behind.
- Ensure clearance requirements are strictly enforced and that all vents are clear of obstructions that can prevent proper air flow around or through the unit.
- Sensitive electronics inside the equipment can be destroyed by static electricity. Be sure to discharge any static electricity built up before touching the equipment and wear appropriate protective gear.

PV Safety



WARNING: Shock Hazard

Photovoltaic (PV) arrays can be energized with minimal ambient light available. Therefore to ensure a safe disconnect from the system, be sure to install a PV disconnect, breaker, or accessible fuse box (depending on local code requirements).



CAUTION: Equipment Damage





PV Arrays must be wired with correct polarity (positive-to-positive, negative-to-negative). Connecting the cables incorrectly can damage or destroy the equipment.

Battery Safety



WARNING: Electrocutation Hazard

- Use the battery types recommended by OutBack Power Systems. Follow the battery manufacturer's recommendations for installation and maintenance.
- Ensure clearance requirements are strictly enforced around batteries.
- Ensure the area around the batteries is well ventilated and clean of debris.
- Always use insulated tools. Avoid dropping tools onto batteries or other electrical parts.
- Keep plenty of fresh water and soap nearby in case battery acid contacts skin, clothing, or eyes.
- If you need to remove a battery, always remove the ground terminal from the battery first. Make sure all accessories are turned off so you don't cause a spark.
- If a remote or automatic generator control system is used, disable the automatic starting circuit and/or disconnect the generator from its starting battery while performing maintenance to prevent accidental starting.

	<p>WARNING: Fire or Burn Hazard</p> <ul style="list-style-type: none"> ➤ Ensure the cables are properly sized. Failure to size the cables properly can result in a Fire Hazard. ➤ Wear complete eye protection and clothing protection when working with batteries. Avoid touching your eyes while working near batteries. ➤ If battery acid contacts skin or clothing, wash immediately with soap and water. If acid enters the eye, immediately flood it with running cold water for at least 20 minutes and get medical attention immediately. ➤ Never smoke or allow a spark or flame near the batteries. ➤ Keep plenty of fresh water and soap nearby in case battery acid contacts skin, clothing, or eyes.
	<p>WARNING: Explosion Hazard</p> <p>Never charge a frozen battery. A flooded battery discharged to 40% SOC (state-of-charge) can freeze at or below -8.9° C (16° F).</p>
	<p>CAUTION: Equipment Damage</p> <p>When connecting cables from the DC input breaker to the battery terminals, ensure proper polarity is observed (positive-to-positive, negative-to-negative). Connecting the cables incorrectly can damage or destroy the equipment.</p>
	<p>IMPORTANT:</p> <p>Baking Soda neutralizes lead-acid battery electrolyte. Vinegar neutralizes NiCad and NiFe battery electrolyte. Have a supply of either substance readily available if using these types of batteries.</p>

Regulatory References

- National Electric Code (NEC) Article 690, (current edition)
- Canadian Electrical Code, Part I (CSA 107.1)
- UL 1741-2005 Static Inverter and Charge Controllers for Use in Photovoltaic Power Systems
- American National Standards Institute/National Fire Protection Agency (ANSI/NFPA) 70

Recycling Information

	<p>IMPORTANT: Recycle Electronics and Batteries</p> <p>Batteries are considered hazardous waste and must be recycled according to local jurisdiction. Inverters and other electronics contain metals and plastics that can (and should) be recycled. The following are some websites and phone numbers that provide information and “how” and “where” to recycle batteries and other electronic equipment.</p> <p>OutBack Power Systems strongly encourages you to learn about recycling and to dispose of recyclable items accordingly. <i>The Earth, and OutBack Power Systems, thanks you for that effort.</i></p>
---	--

Earth 911

Web site: www.Earth911.com
Address: 14646 N. Kierland Blvd., Suite 100
Scottsdale, AZ 85254
Phone: +1.480.337.3025 (direct)

Environmental Protection Agency, USA

Web site: www.epa.gov/recyclecity/
Phone: +1.415.947.8000
(Monday –Friday 8:00 AM to 12:00 PM and 1:00 PM to 4:00 PM PST)
Email: r9.recyclecity@epa.gov

Keep America Beautiful, USA

Web site: www.kab.org/
Address: 1010 Washington Boulevard
Stamford, CT 06901
Phone: +1.203.659.3000 (Main number)
Fax: +1.203.659.3001
Email: info@kab.org

Office of Waste Management, Canada

Address: Office of Waste Management
Conservation and Protection
Environment Canada
Ottawa, Ontario K1A 0H3
Phone: +1. 819.997.2800
Web site: http://www.portaec.net/library/recycling/recycling_in_canada.html

National Institute of Recyclers, Mexico

Web site: <http://www.inare.org.mx/>
Email: a57841279@prodigy.net.mx, margarita@inare.org.mx
Phone: 55.57.85.9160
Fax: 55.57.84.1279

EuroRecycle.net

The following website provides general information about Recycling in Europe. It also provides a list of companies and organizations that provide recycling information or assistance.

Web site: <http://euro.recycle.net/assn/index.html>
E-mail: <http://euro.recycle.net/cgi-bin/feedback1.cgi?w=27>
(This is an online form providing a means to contact the owners of the website.)



Table of Contents

Important Safety Instructions	1
Symbols Used	1
Audience	1
Definitions.....	2
General Safety	2
Personal Safety.....	3
FLEXpower ONE System Safety.....	3
PV Safety.....	4
Battery Safety.....	4
Regulatory References.....	5
Recycling Information	5
Earth 911	6
Environmental Protection Agency, USA.....	6
Keep America Beautiful, USA	6
Office of Waste Management, Canada	6
National Institute of Recyclers, Mexico.....	6
EuroRecycle.net	6
Introduction	11
Components	12
Applications	13
On-Grid Applications	13
Off-Grid Applications.....	14
Grid-Interactive Applications	14
PV Array Planning	15
Battery Bank Planning	15
Generator Requirements.....	16
Preparation	17
Tools Required	17
Materials Required.....	17
Accessories	17
Location.....	17
Environmental.....	17
Clearance and Access Requirements	18
Dimensions.....	19
Conduit and Knockout Preparation.....	20
Mounting.....	21
Removing the Covers.....	24
Accessing the Wiring Compartments	25
Wiring	26
Grounding	26
DC Connections.....	27

AC Connections31

Functional Test/Commissioning 33

 Pre-startup Procedures33

 Energize/Startup33

Reassembling the Enclosures 35

Operation.....39

 Setting Basic Parameters 39

 MATE2 Settings.....39

 Charger Settings.....39

 Setting Time, Date & Display on the MATE240

 Selecting the AC Source and AC Input Limit on the Inverter42

 Accessing the Advanced Menu43

 Setting Battery Amp-Hours and Return Amps using the FLEXnet DC Monitor44

 Setting Charging Parameters45

 De-energize/Shutdown46

Specifications.....49

 Feature Matrix 49

 Electrical Specifications, 120 Vac/60 Hz Models 50

 Mechanical Specifications, 120 Vac/60 Hz Models..... 50

 Electrical Specifications, 230 Vac/50 Hz Models 51

 Mechanical Specifications, 230 Vac/50 Hz Models..... 51

 Surge Protector 52

 LEDs52

 Renewable Energy Input & Storage..... 53

 PV Sizing53

 Battery Bank Sizing53

 Amp-Hour Requirements53

Wiring Configurations59

 FLEXpower ONE with FLEXnet DC Monitor and GFDI..... 61

 FLEXpower ONE with FLEXnet DC Monitor Only (no GFDI) 62

 FLEXpower ONE with GFDI Only (no FLEXnet DC Monitor) 63

 FLEXpower ONE (no FLEXnet DC Monitor or GFDI) 64

Warranty65

 How to Arrange for Warranty Service 66

 Return Material Authorization (RMA)66

 Returning Product to OutBack66

Index67

List of Tables

Table 1 Acronyms..... 2
Table 2 Basic Components of a FLEXpower ONE System..... 12
Table 3 Ground Conductor Size and Torque Requirements..... 26
Table 4 DC Conductor Size and Torque Requirements..... 27
Table 5 AC Conductor Size and Torque Requirements 31
Table 6 Feature Matrix..... 49
Table 7 Worksheet for Determining Average Daily Load in Amp-hours 56
Table 8 Worksheet for Determining Battery Bank Size 57

List of Figures

Figure 1	FLEXpower ONE System Overview	11
Figure 2	Basic Components of a FLEXpower ONE System.....	12
Figure 3	On-Grid Applications (Example).....	13
Figure 4	Off-Grid Applications (Example).....	14
Figure 5	Grid-Interactive Applications (Example).....	14
Figure 6	Clearance and Access Requirements	18
Figure 7	Dimensions	19
Figure 8	Conduit and Knockout Preparation.....	20
Figure 9	Installing the Mounting Bracket	22
Figure 10	Attaching the Mounting Plate to the Mounting Bracket	23
Figure 11	Removing the Covers	24
Figure 12	Wiring and Breaker Compartment.....	25
Figure 13	Ground Connections	27
Figure 14	Battery Connections with the FLEXnet DC Monitor.....	28
Figure 15	Battery Connections without the FLEXnet DC.....	29
Figure 16	PV Connections with a FLEXnet DC Monitor	30
Figure 17	AC IN Connections.....	31
Figure 18	AC OUT Connections.....	32
Figure 19	Energize Procedures	33
Figure 20	Functional Test Procedures for Initial Startup.....	34
Figure 21	Replacing the Raceway and FLEXmax 80 Front Cover	35
Figure 22	Replacing the Inverter's AC Terminal Access Cover.....	35
Figure 23	Replacing the AC Enclosure Front Cover.....	36
Figure 24	Replacing the AC Enclosure Top Cover	36
Figure 25	Replacing the DC Enclosure Front Cover.....	37
Figure 26	Replacing the DC Cover.....	37
Figure 27	MATE2 Setup Screen (Page 1)	40
Figure 28	MATE2 Setup Screen (Page 2 and 3)	41
Figure 29	Inverter Setup Screen – Selecting AC Source.....	42
Figure 30	Accessing the Advanced Menus.....	43
Figure 31	Setting Battery Amp-hours and Return Amps	44
Figure 32	Setting Input Source and Current Limit	45
Figure 33	Shutdown Procedures.....	46
Figure 34	Functional Test Procedures to Confirm the Unit is De-energized.....	47
Figure 35	FLEXpower ONE with FLEXnet DC Monitor and GFDI	61
Figure 36	FLEXpower ONE with FLEXnet DC Monitor Only (No GFDI).....	62
Figure 37	FLEXpower ONE with GFDI Only (no FLEXnet DC Monitor)	63
Figure 38	FLEXpower ONE (no FLEXnet DC Monitor or GFDI)	64



Introduction

Thank you for choosing a FLEXpower ONE System from OutBack Power Systems. FLEXpower ONE is an integrated power system solution designed to be quick to install and easy to use.

The FLEXpower ONE System is intended for off-grid and on-grid applications up to 3.6 kW. It is intended for use with photovoltaic (PV) modules for harvesting energy and a battery bank for energy storage. FLEXpower ONE can also be configured as “Grid-interactive” meaning that excess energy (energy that exceeds usage) will be returned to the Grid (Sell Mode).

The FLEXpower ONE System is designed with the following features:

- 3.5 kW and 3.6 kW units.
- 120 Vac/60 Hz configurations and 230/50 Hz configurations
- Rated for Indoor Installations
- Includes mounting bracket for wall-mounting
- Charge controller uses MPPT technology to maximize the harvest from solar modules
- Grid-interactive capable (requires a configuration that features a GVFX Inverter)
- Battery status monitor takes independent shunt measurements of PV and inverter power
- Includes OutBack’s Surge Protector for additional protection against damaging power surges

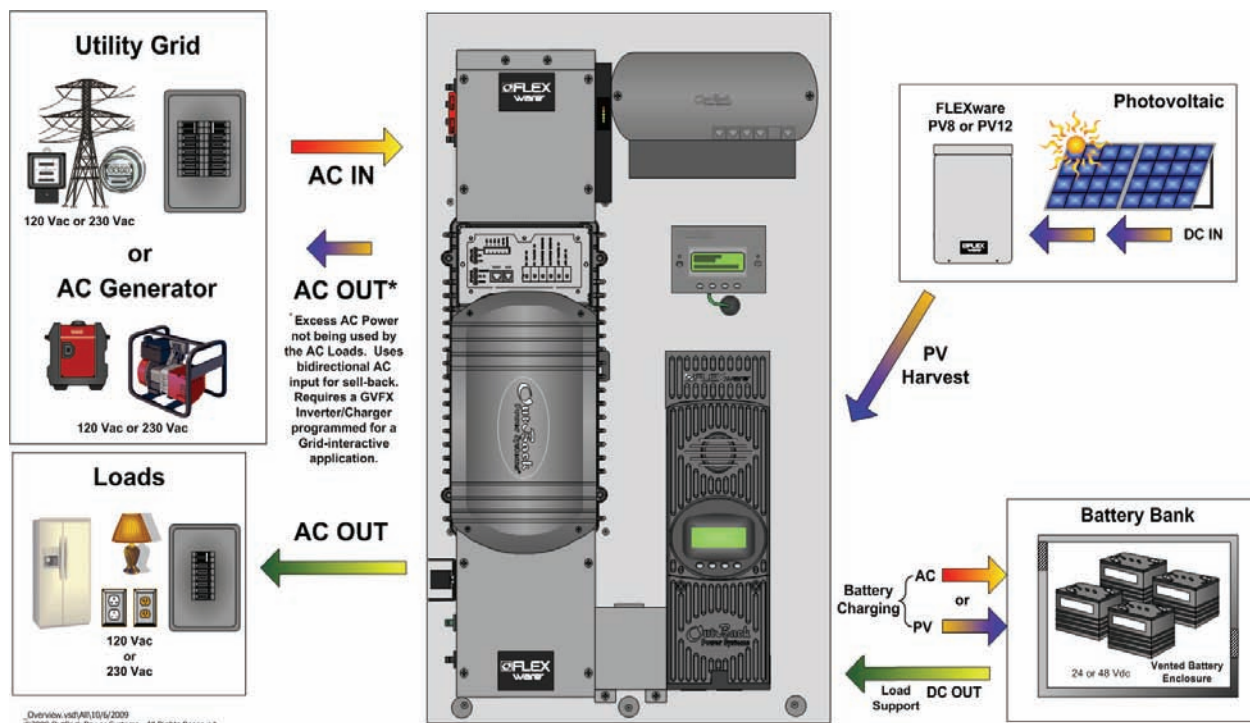

Figure 1 FLEXpower ONE System Overview

Components

A complete FLEXpower ONE is composed of the following components. See page 49 for details on specific configurations.

Table 2 Basic Components of a FLEXpower ONE System

Components	Documentation
FX Series Inverter/Charger (VFX or GVFX)	FLEXpower ONE Installation Manual (this book)
Mounting Plate (with mounting bracket)	
MATE Remote Control and Display	
AC Enclosure (120 V-NA or 230 V-EU)	
DC Enclosure (125, 175, or 250A)	
FLEXnet DC Battery Monitor	
FLEXmax 80 Charge Controller	
Raceway	
HUB4 Communication Manager	
FLEXware Surge Protector	
	Additional Reference Documents
	MATE Installation and User's Manual
	FLEXnet DC Monitor
	FX or Grid-Interactive Programming Manual
	FLEXmax 80 User's Manual
	HUB4 Communication Manager User's Manual

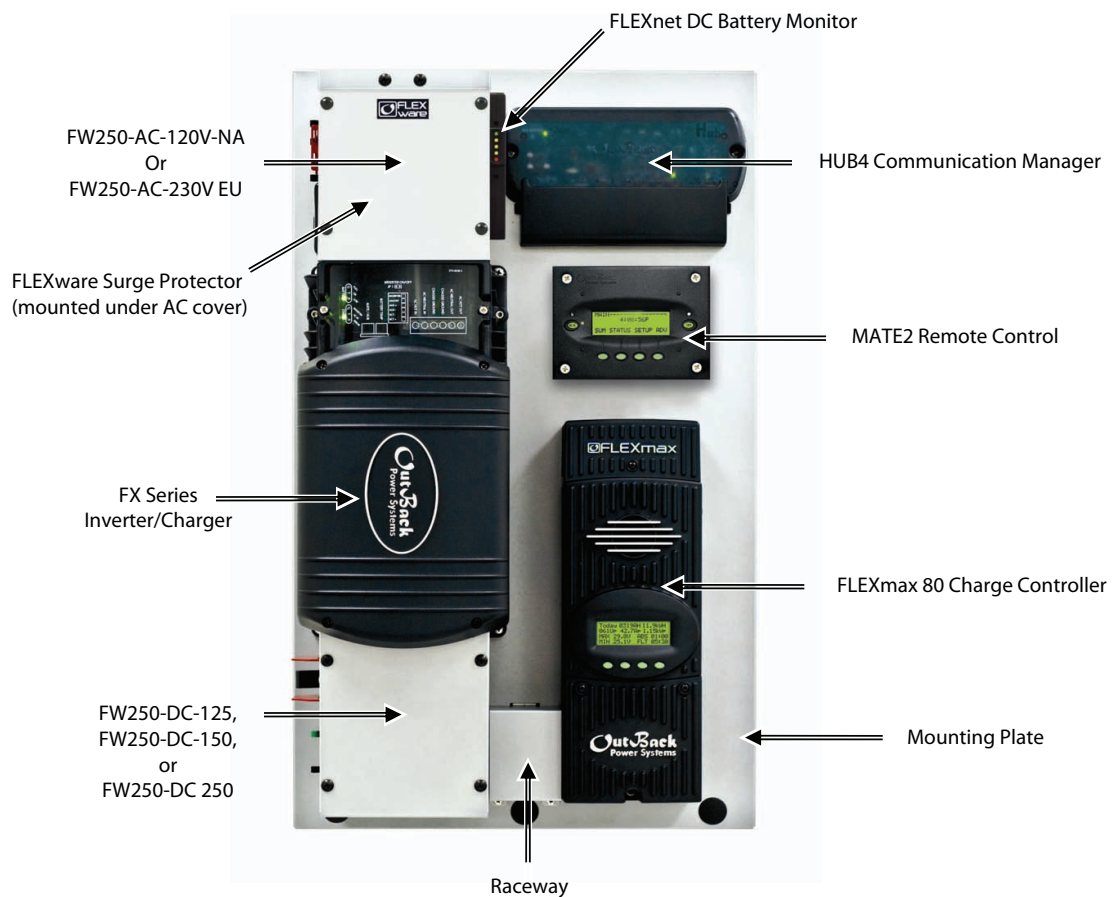

Figure 2 Basic Components of a FLEXpower ONE System



Planning

Applications

The FLEXpower ONE is intended for on-grid, off-grid, and grid-interactive applications. It is designed to use photovoltaic (PV) panels to harvest solar energy and a battery bank to store the harvested energy.

On-Grid Applications

In on-grid applications, the FLEXpower ONE can use the grid power as the primary power source or as the backup source of power. If the FLEXpower ONE is used as backup to the grid, the FLEXpower ONE will take over when the grid fails. If the FLEXpower ONE is used as the primary source, the grid power will be used when the batteries have been drained. In this situation, the AC power or PV harvest can be used to recharge the battery bank.

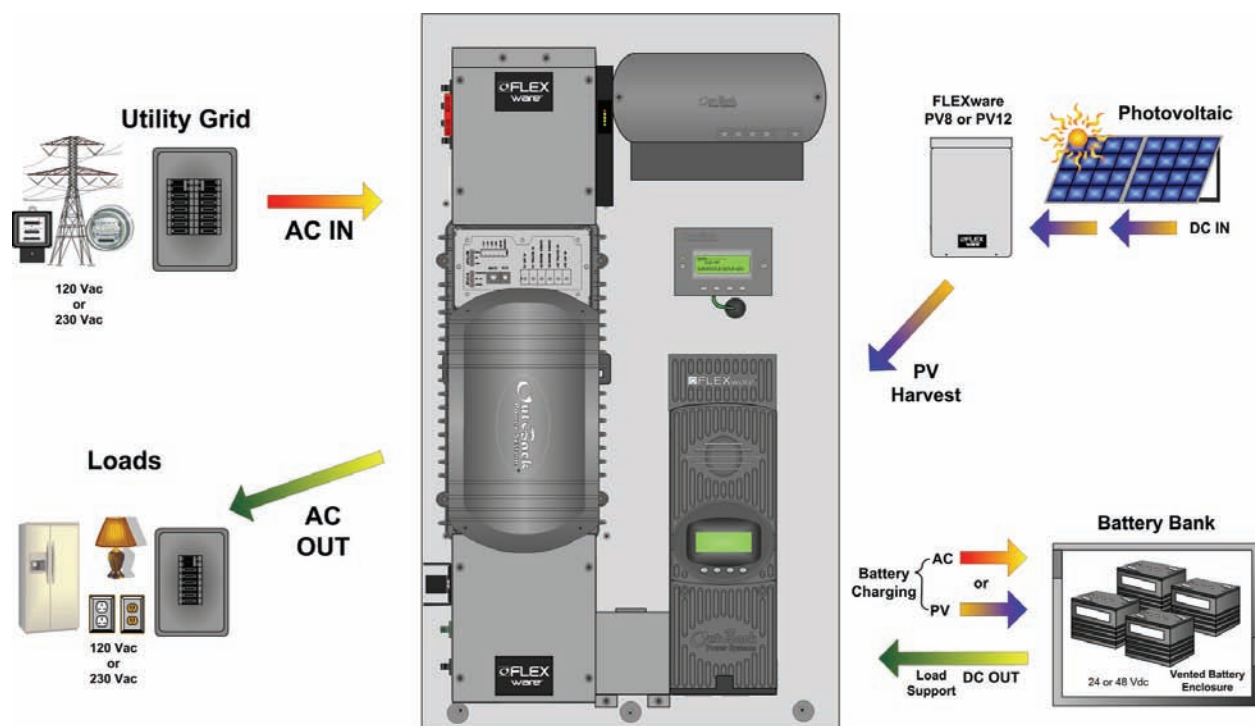

Figure 3 On-Grid Applications (Example)

Off-Grid Applications

In off-grid applications, the FLEXpower ONE can use the harvested energy from the battery bank as the primary power source. An AC generator can also be connected to support the system when required.

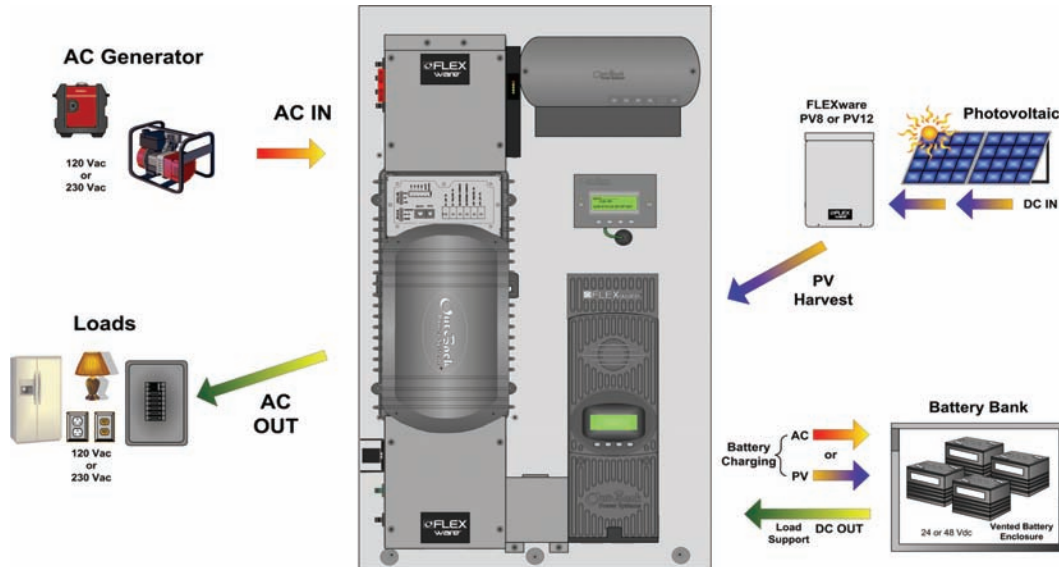

Figure 4 Off-Grid Applications (Example)

Grid-Interactive Applications

In grid-interactive applications, grid power is used to run the loads. When excess PV is available from the batteries, the FLEXpower ONE supports those loads with the PV. When the PV exceeds the load requirements, the FLEXpower ONE sells that excess power back through its input, to the utility grid. When the utility grid is not available, the FLEXpower ONE takes over to run the loads with PV and energy stored in the battery bank.

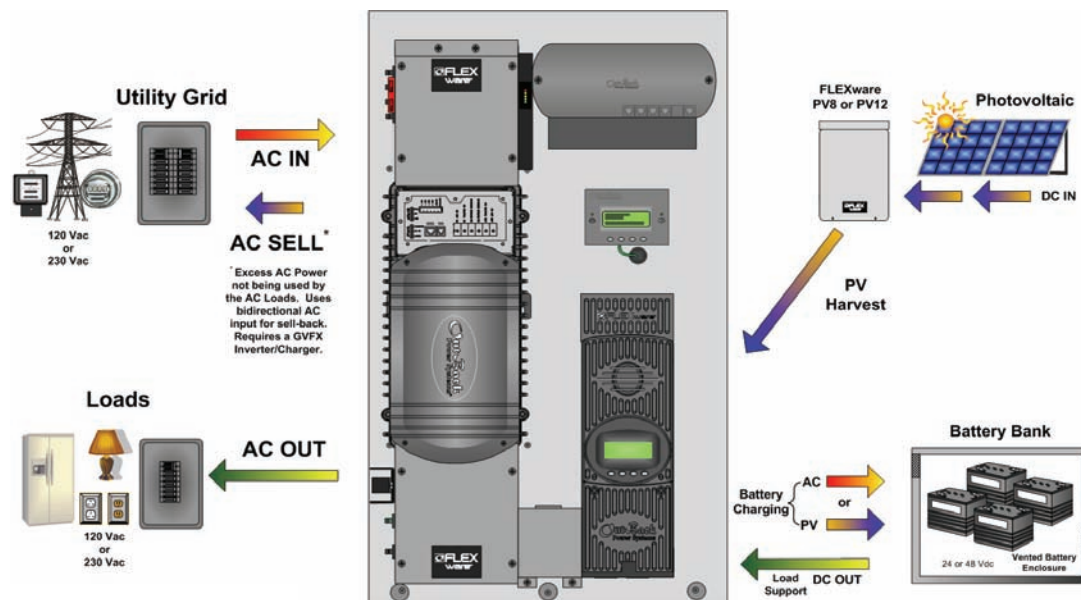

Figure 5 Grid-Interactive Applications (Example)

PV Array Planning

The FLEXpower ONE is designed to use PV input to charge the battery bank. The FLEXmax 80 charge controller(s) integrated into the FLEXpower ONE System uses Maximum Power Point Tracking (MPPT) technology to maximize the PV harvest. A PV Combiner box (not included) may be required for multiple PV strings. PV Combiner Boxes are available from OutBack Power Systems for 8 to 12 PV strings.

FLEXpower ONE includes one FLEXmax 80 Charge Controller. The charge controller allows input from a single PV array. The PV input can support the following PV configuration.

- 4,000 W_{STC} on 48 Vdc system, 2,000 W_{STC} on 24 Vdc system
- 150 V_{OC} including local temperature correction factor per NEC 690.7
- 64 A I_{SC} maximum PV array current per NEC 690.8

For a PV Planning Tool, see the following website.

http://outbackpower.com/resources/string_sizing_tool/

Battery Bank Planning

Types of Batteries

- The FLEXpower ONE System supports a 24 or 48 Vdc battery bank, depending on the inverter that is featured in the configuration. Before constructing a battery bank, check the model number on the side of the inverter to confirm the nominal battery voltage.
- A vented enclosure for the battery bank may be required by electric code.

Bank Sizing

In general, the size of the loads (watts) and the required backup period (hours) will determine best size for the battery bank. To calculate this, use the information provided on page 53 through page 57. Worksheets are provided for assistance.

Generator Requirements



IMPORTANT:

- All connections must comply with local electric code.
- Generator grounding and neutral-to-ground bonding should be provided in accordance with specific system configuration and national/local code requirements.
- Follow the manufacturer's recommendations for fuel type and maintenance.

The following are general requirements for using a generator with the FLEXpower ONE.

- Electrical Requirements
 - ~ North American Applications: 120 Vac / 60 Hz
 - ~ European Applications: 230 Vac / 50 Hz
- Minimum available generator power* should be equal to or greater than nominal inverter rating (*after de-ratings for peak versus continuous power, for load power factor considerations, for altitude, and for ambient temperature).
 - ~ A generator with a de-rated power specification smaller than that of the inverter may not be able to handle all downstream AC loads and/or the built-in battery charger.
 - ~ A generator with a de-rated power specification larger than that of the inverter may be required to handle the built-in battery charger as well as all downstream AC loads.
 - ~ Available power from the generator may be further limited by ratings for circuit breakers and/or generator output connectors. "Full" generator output power may not be available from a single generator connector.
 - ~ Generator sizing may be affected by start-up surge current requirements of 3X to 6X normal operating current for some loads (i.e., motors with large loads).
 - ~ The inverter and/or downstream loads may have difficulty operating from poorly-regulated generators (voltage, frequency, load).
- Grid-interactive inverters typically require inverter-type generators.
- Split-phase generators (i.e., 120/240 Vac / 60 Hz) can be adapted to a single-phase inverter using an autotransformer such as the X-240. For additional information, see...
 - ~ PSX-240 Manual: http://www.outbackpower.com/pdf/manuals/PSX-240_Installation_Manual.pdf
 - ~ X-240 Manual: <http://www.outbackpower.com/pdf/manuals/fw-x240.pdf>
- The OutBack MATE can be used to program an inverter's AUX output to start and stop a generator. This 12 V output can often control a two-wire-start generator directly. Three-wire-start generators require an interface such as an Atkinson module. For additional information, see...
 - ~ OutBack Power Systems AGS Brochure: http://www.outbackpower.com/pdf/brochures/Automatic_Generator_Start.pdf
 - ~ OutBack Power Systems MATE Manual: <http://www.outbackpower.com/pdf/manuals/mate.pdf>
 - ~ Atkinson Electronics: <http://atkinsonelectronics.com/>

Preparation

Tools Required

The following tools may be required for installing this equipment.

- Wire cutters/strippers
- Torque wrenches
- Assorted insulated screw-drivers
- Drill and drill-bits
- Ratchet drives
- Digital Voltmeter

Materials Required

The following materials may be required for installing this equipment.

- Conductors for wiring
- Conduits, bushings
- Anchor Bolts (x4) or Dry-wall (x6) screws for mounting
- Plywood (optional, for additional wall support)

Accessories

The following accessories are available for purchase.

- PV8/PV12 Combiner Box
- See the OutBack catalog for a complete list of other parts and components that are available.

Location

- FLEXpower ONE is rated for indoor installations.
- In areas where seismic activity is a concern, consult local code for seismic safety requirements.

Environmental

- This unit is performance rated at 25°C (77°F). Exposure to extreme hot temperatures can reduce the unit's performance. When used in an outdoor installation, use a shading structure to avoid direct exposure to sunlight.
- The mounting surface should be vertical, smooth, and able to support three (3) times the weight of the enclosure (98 lb, or 44.5 kg). This may require additional support for wall-mounted installations.

Clearance and Access Requirements



WARNING: Fire/Explosion Hazard

Do not place combustible or flammable materials within 12 feet (3.7 m) of the equipment. This unit employs mechanical relays and is not ignition-protected. Fumes or spills from flammable materials could be ignited by sparks.



IMPORTANT:

Clearance and access requirements may vary by location. Maintaining a 36" (0.91 cm) clear space in front of the system for access is recommended. Consult local electric code to confirm clearance and access requirements for the specific location.

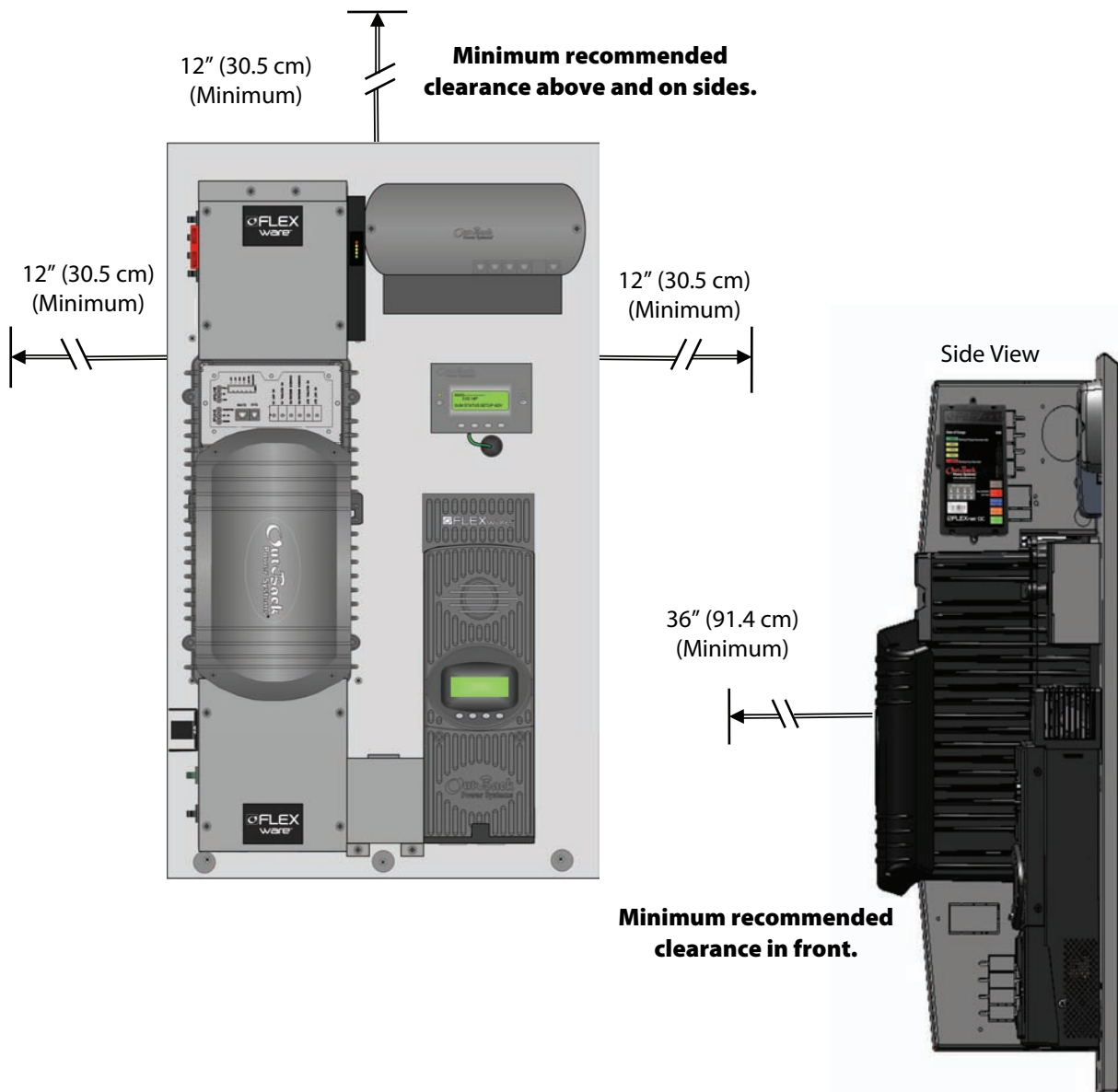
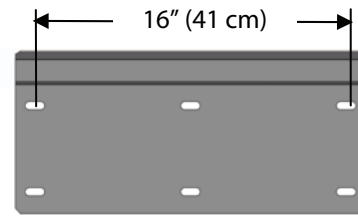
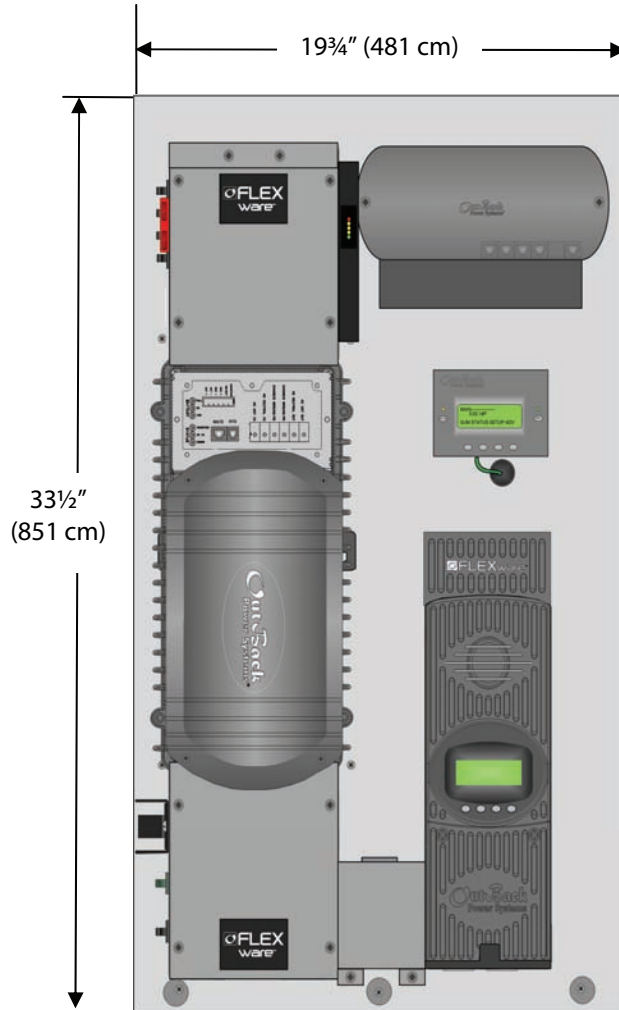

Figure 6 Clearance and Access Requirements

Dimensions



Mounting Bracket



Side View

Figure 7 **Dimensions**

Conduit and Knockout Preparation

Knockouts (two 1", one 2") are provided on the ends of the AC and DC enclosures for routing cable into the enclosures. Conduit and bushings are recommended to prevent damage to conductors from sharp edges along knockout holes.

1. Remove the 2" knockout on the DC end to accommodate the larger battery cables and Remote Temperature Sensor cable.
2. Remove the 1" knockout(s) on the AC end to accommodate the AC cabling.
3. Install conduit and bushings to protect the cable from damage from the sharp edges of the hole.
4. Ensure no debris or metal shavings have fallen into the enclosures.

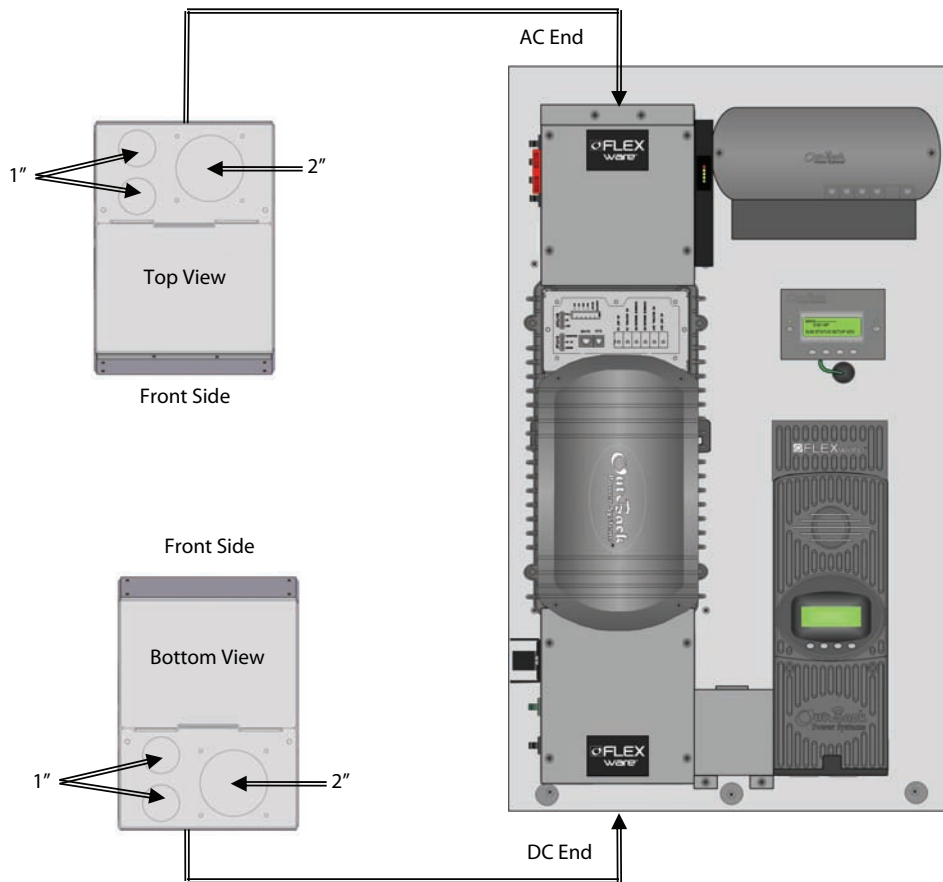

Figure 8 Conduit and Knockout Preparation



Installation

The FLEXpower ONE system is designed for flexibility and easy installation. The system comes attached to a mounting plate with the selected components pre-installed and wired. The Mounting Plate attaches to a mounting bracket that attaches to a wall.



WARNING: Personal Injury

- This equipment weighs 98 lbs (44.5 kg). Use safe lifting techniques when lifting this equipment as prescribed by the Occupational Safety and Health Association (OSHA) or other local codes.
- Use standard safety equipment such as safety glasses, ear protection, steel-toed safety boots, safety hard hats, etc. as prescribed by the Occupational Safety and Health Association (or other local codes) when working on this equipment.
- Use standard safety practices when working with electrical equipment (e.g., remove all jewelry, use insulated tools, wear cotton clothing, etc.)
- Never work alone when installing or servicing this equipment. Have someone nearby that can come to your aid if necessary.

Mounting

The FLEXpower ONE is designed to be wall-mounted, indoors. The mounting bracket has six holes in it with the outside holes measuring 16" center-to-center. This allows the mounting bracket to be secured to wall studs 16" apart. If the wall studs are 24" apart, the center mounting holes should be used to secure the bracket to the wall stud and the outside holes should be used for extra stability.



IMPORTANT:

The mounting surface should be able to hold three times the combined weight of all the components. A sheet of 3/4" plywood may be required to meet this requirement. Check with local code to ensure regulatory compliance for stability and cabling.

To install the Mounting Bracket:

1. Note the height of the Mounting Plate as indicated in Figure 7.
2. Place the Mounting Bracket at the desired height for the panel. The bottom of the bracket is recommended to hang at about eye level.
3. Secure the Mounting Bracket to the wall as shown in Figure 9. Use all six mounting slots provided on the bracket, if possible.
4. Lift the Mounting Plate above the Mounting Bracket. Slip the top of the Mounting Plate over the angled lip of the Mounting Bracket. See Figure 10 on page 23.
5. Secure the lower back flange of the Mounting Plate to the wall (with appropriate hardware), using the rear flange slots as shown in Figure 10 on page 23.
6. Insert all three 1" nylon hole plugs into the rear slot access holes.

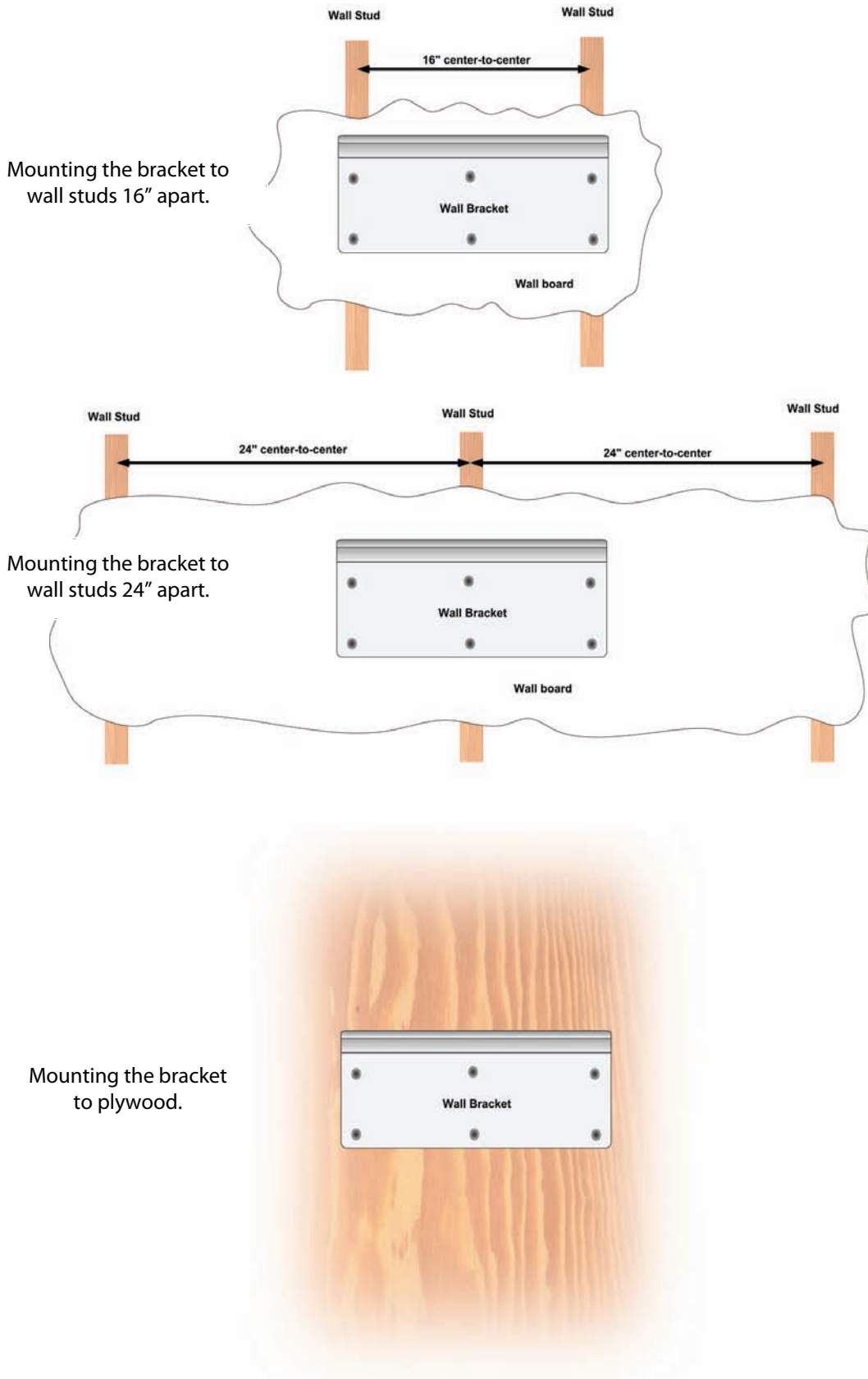
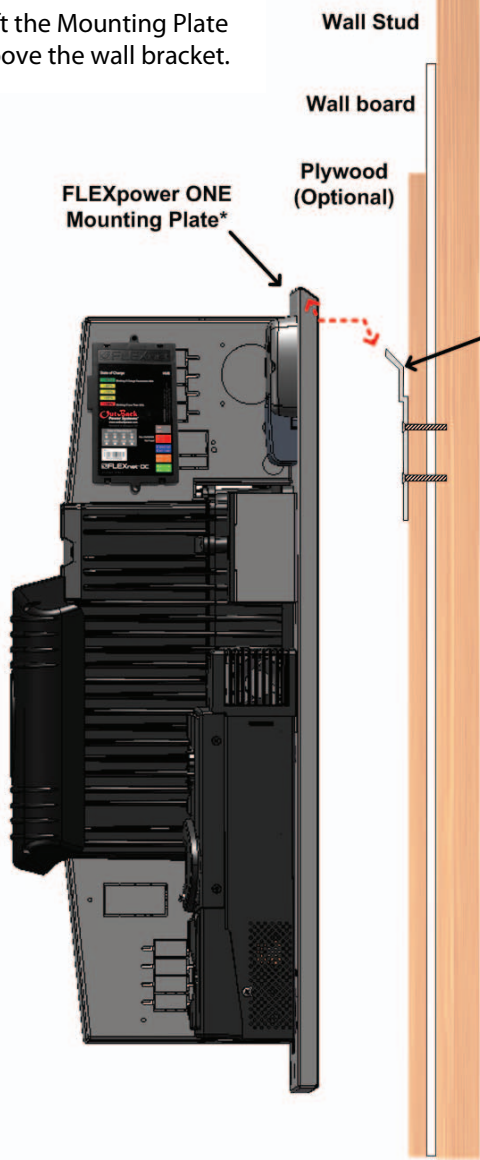

Figure 9 Installing the Mounting Bracket

Lift the Mounting Plate above the wall bracket.



Side View

Slip the top of the Mounting Plate over the angled lip of the wall bracket.

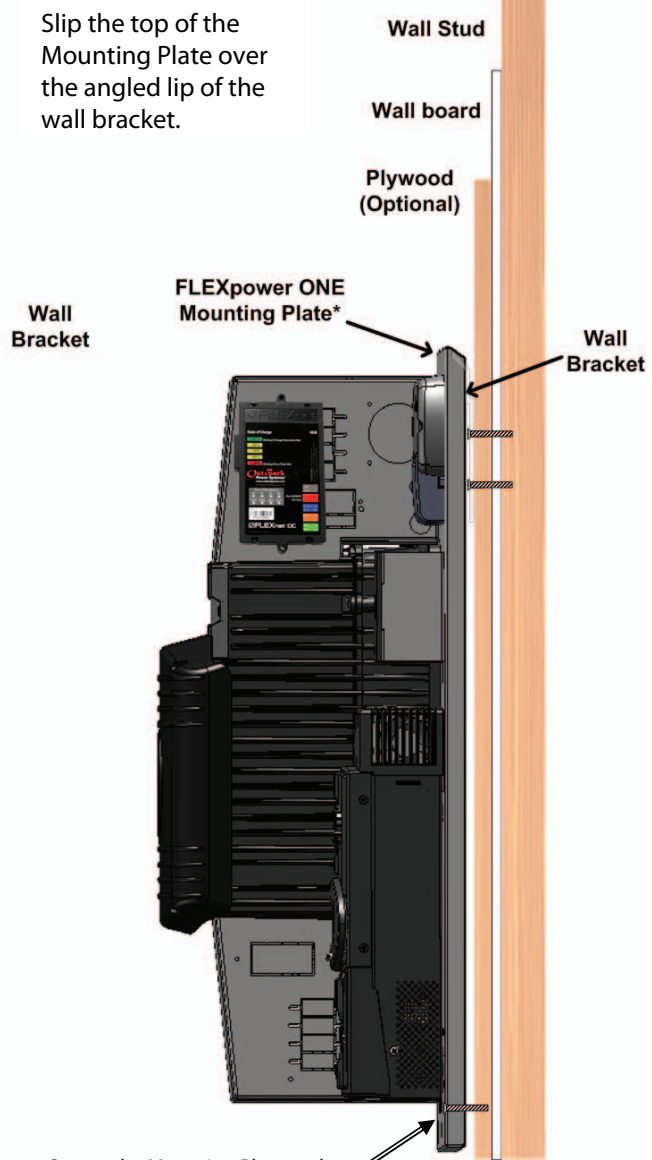

Side View

Secure the Mounting Plate to the wall at the 3 locations shown below.

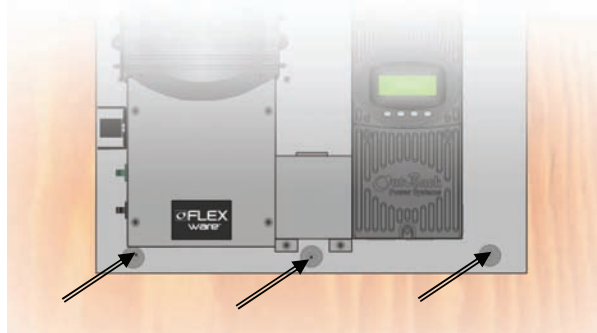

Secure the Mounting Plate to the wall at the 3 locations shown here.

Figure 10 Attaching the Mounting Plate to the Mounting Bracket

Removing the Covers

Remove the screws in the AC Enclosure's **Front Cover** (x4). Gently pull the Front Cover away from the chassis being careful not to disconnect or damage the wiring for the Surge Protector. *The Front Cover cannot be completely removed due to the Surge Protector wiring (see page 52).*

Remove the screws on the **AC Access Cover** (x2).

Note: The AC Enclosure has two covers: the access cover and the front cover. Both covers need to be opened to make conductor connections. Once connections are made, the access cover can be used for visual inspection, so that the wiring will not be disturbed when inspected by the local electrical authority.

Remove the screws on the **Inverter Terminal Access Cover** (x2).

Remove the screws on the **Inverter DC Cover** (x4).

Remove the screws on the **DC Enclosure Front Cover** (x4).

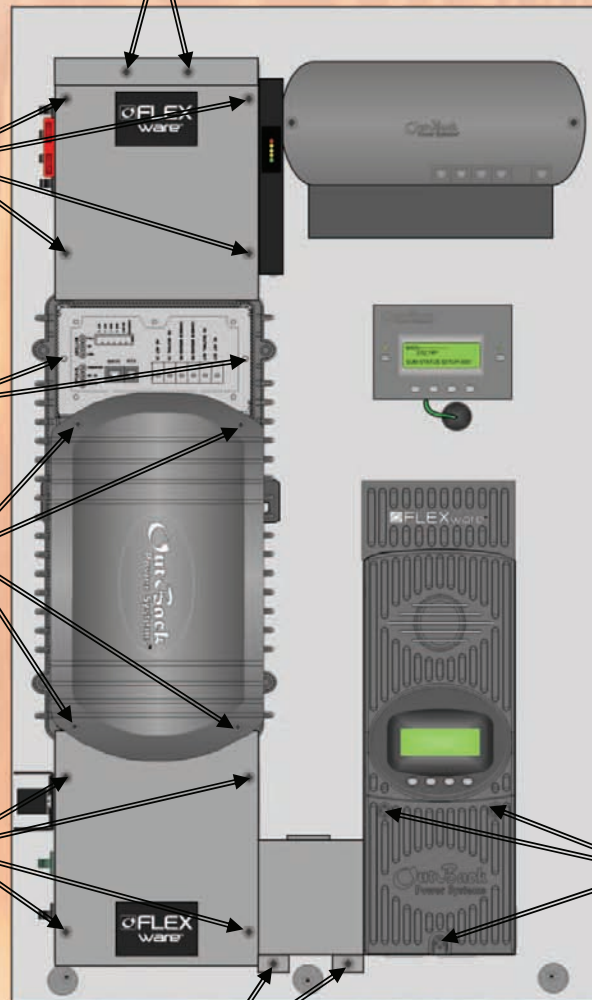

¹Remove the screws on the **FLEXMax 80 Charge Controller** (x3).

¹Remove the screws on the **Raceway** (x2).

¹The Raceway and front cover on the FLEXmax 80 Charge Controller only need to be removed if the FLEXnet DC Monitor is included in the configuration.

Figure 11 Removing the Covers

Accessing the Wiring Compartments

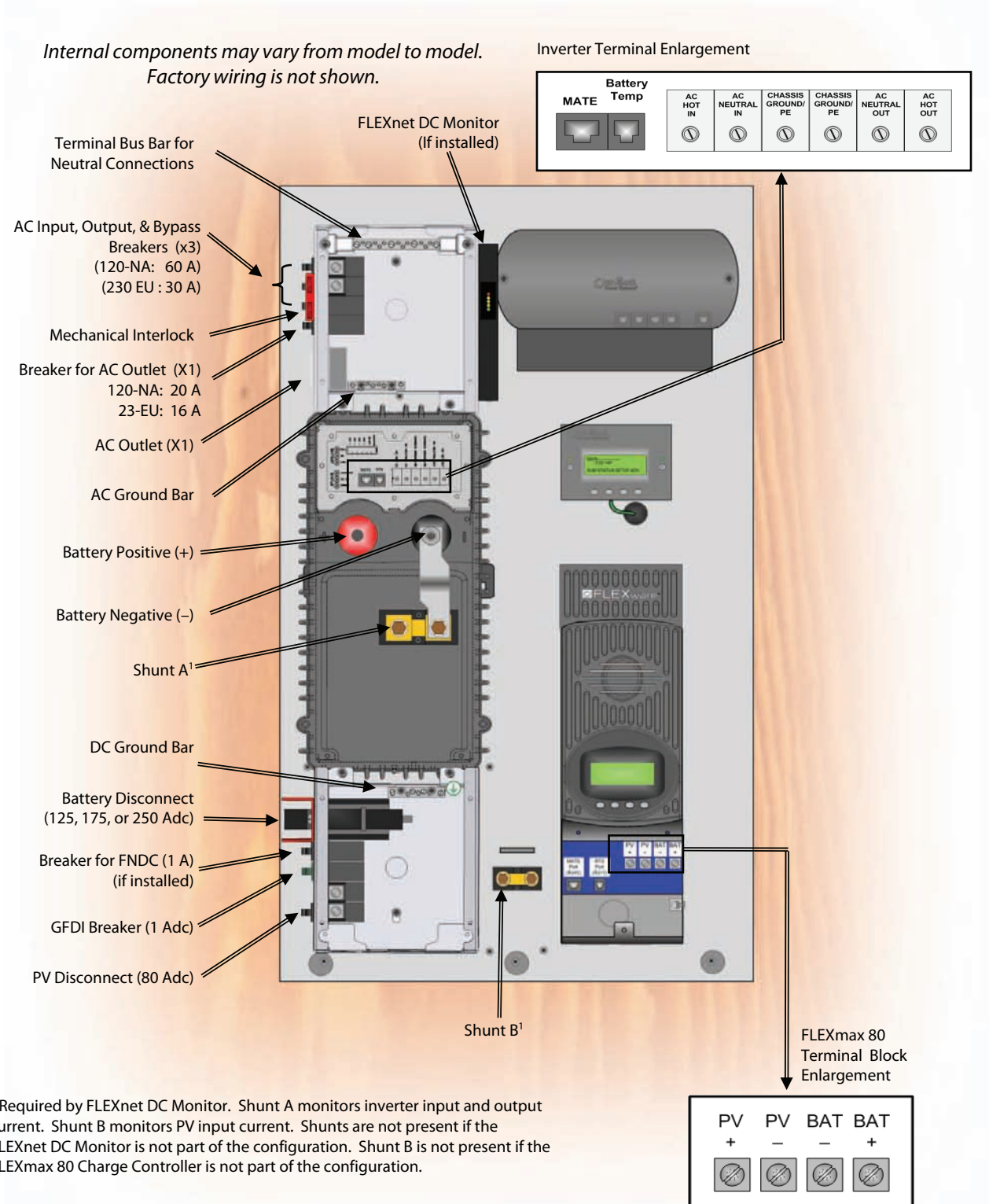

Figure 12 Wiring and Breaker Compartments

Wiring



IMPORTANT:

- All connections must comply with local electric code. Local code may require sizes other than those recommended in this manual. For all wiring, use copper conductors rated at 75°C minimum.
- If the installation involves grid-tie activities such as selling power back to the grid, per NEC 690, ensure the total value of the breakers installed in either the main AC distribution panel or the AC sub-panel does not exceed the total rating on the terminal distribution bus in the distribution panel. In other words, if the main terminal distribution bus in the panel is rated for 100 amps, then the total value of all the breakers installed can not exceed 100 amps.
- The size of the breaker installed to support the inverter should not exceed 60 A maximum.
- When smaller AC sources are used, smaller AC wiring may be used (down to the minimum sizes indicated in Tables 4 and 6). The external AC breakers must be sized accordingly to protect smaller wires.

Grounding



IMPORTANT:

- System grounding is the responsibility of the installer.
- Grounding requirements may vary by location depending on the local electric code. In North America, inverter systems are considered two separate electrical systems and, therefore, are required by code to have each system (AC and DC) connected to a ground electrode conductor (also known as a primary system ground).
- The AC and DC circuits are not bonded to the FLEXware enclosure.
- The equipment ground is marked with this symbol:



WARNING:

Ensure there is only one Neutral-to-Ground Bond in the system. The FLEXpower ONE comes with a Neutral-to-Ground Bond installed. If a Neutral-to-Ground bond exists elsewhere in the system, the Neutral-to-Ground Bond in the FLEXpower ONE will need to be removed. See Figure 18. Check local code for specific requirements.

Table 3 Ground Conductor Size and Torque Requirements

Terminal Location	Minimum Allowed Conductor Size	Maximum Conductor Size	Torque Requirements
Ground Bar	#12 AWG (3.3 mm ²)	1/0 AWG (53.5 mm ²)	35 in-lb (4 Nm)

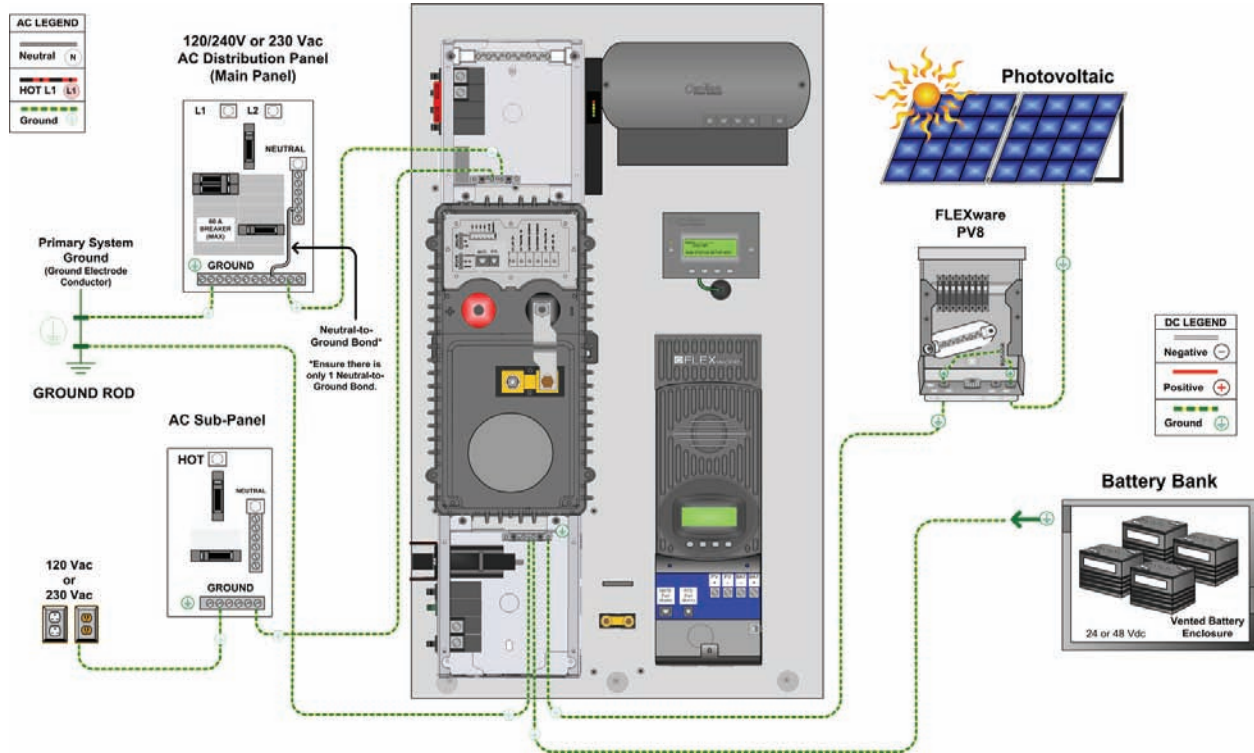

Figure 13 Ground Connections

DC Connections

Table 4 DC Conductor Size and Torque Requirements

DC Terminal	Minimum Allowed Conductor Size	Maximum Conductor Size	Torque Requirements	Breaker Size
Battery Positive (+)	2/0 AWG (67.5mm ²)	N/A (ring terminal)	50 in-lb (5.7 Nm)	175 Adc
Battery Negative (-) (Shunt)	2/0 AWG (67.5 mm ²)	N/A (ring terminal)	50 in-lb (5.7 Nm)	N/A
PV Positive (+)	#4 AWG (21.2 mm ²)	#2 AWG (33.6 mm ²)	35 in-lb (4 Nm)	80 Adc
PV Negative (-)	#4 AWG (21.2 mm ²)	#2 AWG (33.6 mm ²)	35 in-lb (4 Nm)	N/A
Ground Bus Bar	#12 AWG (3.3 mm ²)	1/0 AWG (53.5 mm ²)	35 in-lb (4 Nm)	N/A

- To make the battery connections in systems that have the FLEXnet DC Monitor, see Figure 14 on page 28.
- To make the battery connections in systems that do not have the FLEXnet DC Monitor, see Figure 15 on page 29.
- To make the PV connections, see Figure 16 on page 30.

To make the battery connections in a system with the FLEXnet DC Monitor:

1. Remove all hardware from the side of Shunt A that is not connected to the Inverter.
2. Place the Inverter Negative (-) cable lug and Charge Controller Negative (-) cable lug onto Shunt A. Secure in place with the Flat Washer, Lock Washer and Nut. Torque to 50 in-lb (5.7 Nm).
3. Connect the Battery (+) conductor to the DC Breaker lug closest to the Mounting Panel. Torque to 50 in-lb (5.7 Nm).
4. Attach one end of the Battery Temperature Sensor (RTS) cable to the BATT TEMP port on the Inverter and the other side to one of the batteries in the middle of the Battery Bank.

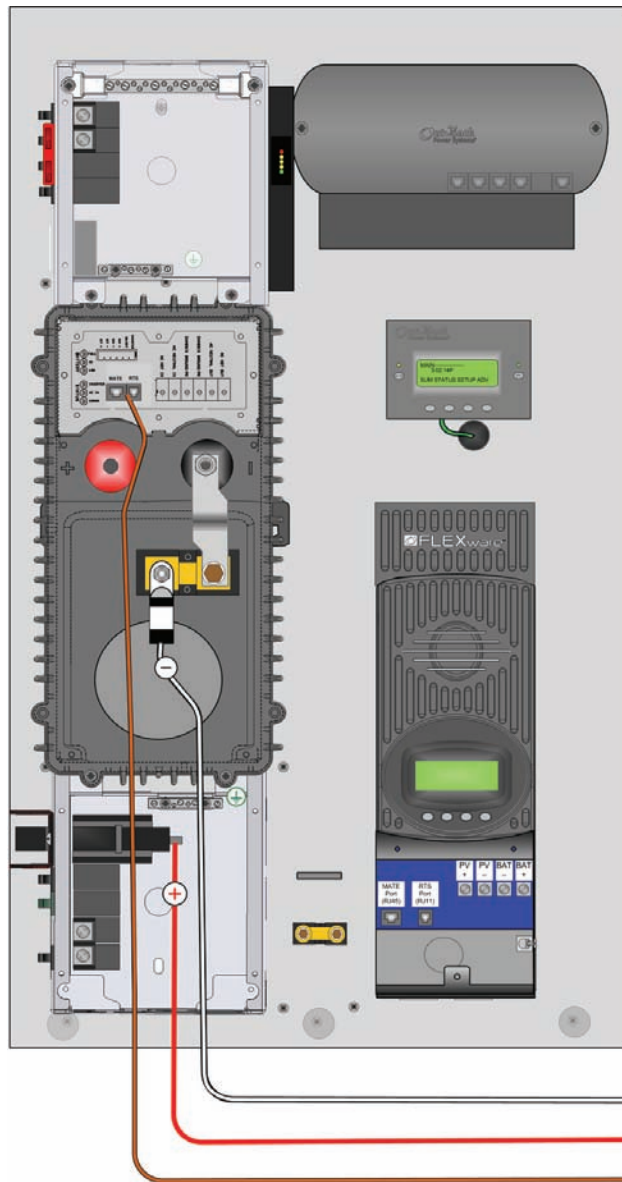

Internal components shown may vary from model to model.
Factory wiring is not shown.

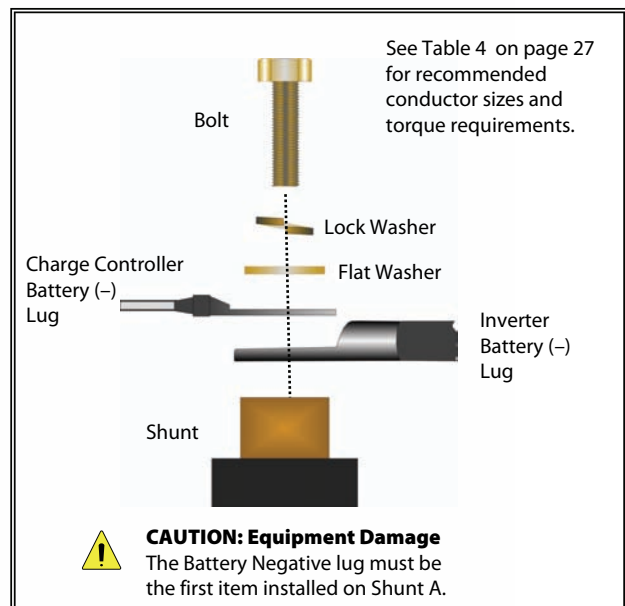

Battery Bank

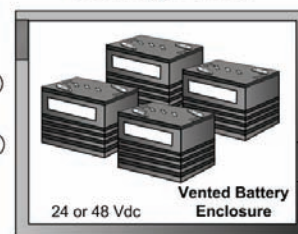

CAUTION: Equipment Damage
Ensure that correct polarity is observed when connecting battery cables.

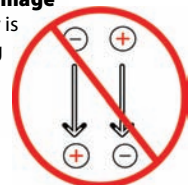
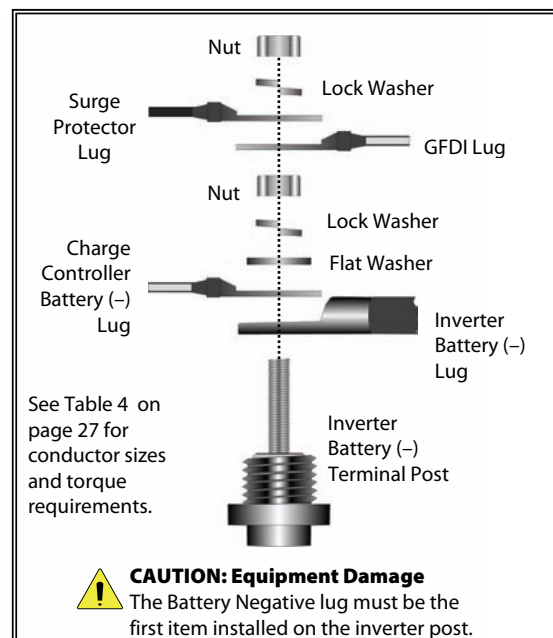
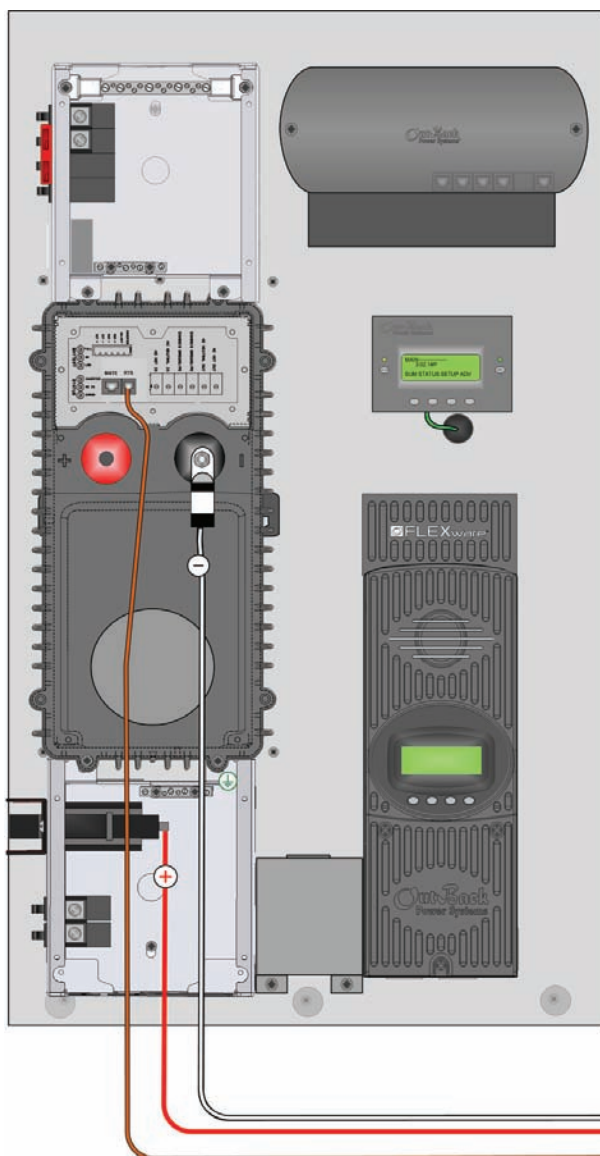

Figure 14 Battery Connections with the FLEXnet DC Monitor

To make the battery connections in a system without the FLEXnet DC Monitor:

1. Remove all hardware from the inverter's battery negative (-) terminal post.
2. Place the Inverter Negative (-) cable lug and Charge Controller Negative (-) lug onto the terminal post. Secure in place with the Flat Washer, Lock Washer and Nut. Torque to 50 in-lb (5.7 Nm).
3. Place the GFDI cable lug and Surge Protector DC Negative (-) cable lug onto the terminal post. Secure in place with the next Lock Washer and Nut. Torque to 35 in-lb (4 Nm)
4. Connect the Battery (+) conductor to the DC Breaker lug closest to the Mounting Panel. Torque to 50 in-lb (5.7 Nm).
5. Attach one end of the Battery Temperature Sensor (RTS) cable to the BATT TEMP port on the Inverter and the other side to one of the batteries in the middle of the Battery Bank.

Internal components shown may vary from model to model. Factory wiring is not shown.



Battery Bank

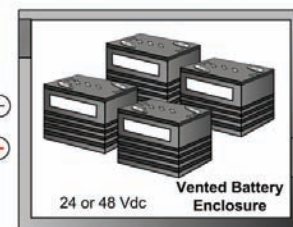

CAUTION: Equipment Damage
Ensure that correct polarity is observed when connecting battery cables.



Figure 15 Battery Connections without the FLEXnet DC

To make the PV connections:

1. Ensure the PV array is properly grounded.
2. Route the PV (-) through the bottom of the DC enclosure and into the wiring compartment of the FM80 charge controller. Connect the PV (-) conductor to the PV (-) terminal in the FM80 charge controller. Torque to 35 in-lb (4 Nm).
3. Connect the PV (+) to the top terminal of the PV Disconnect in the DC Enclosure. Torque to 35 in-lb (4 Nm).

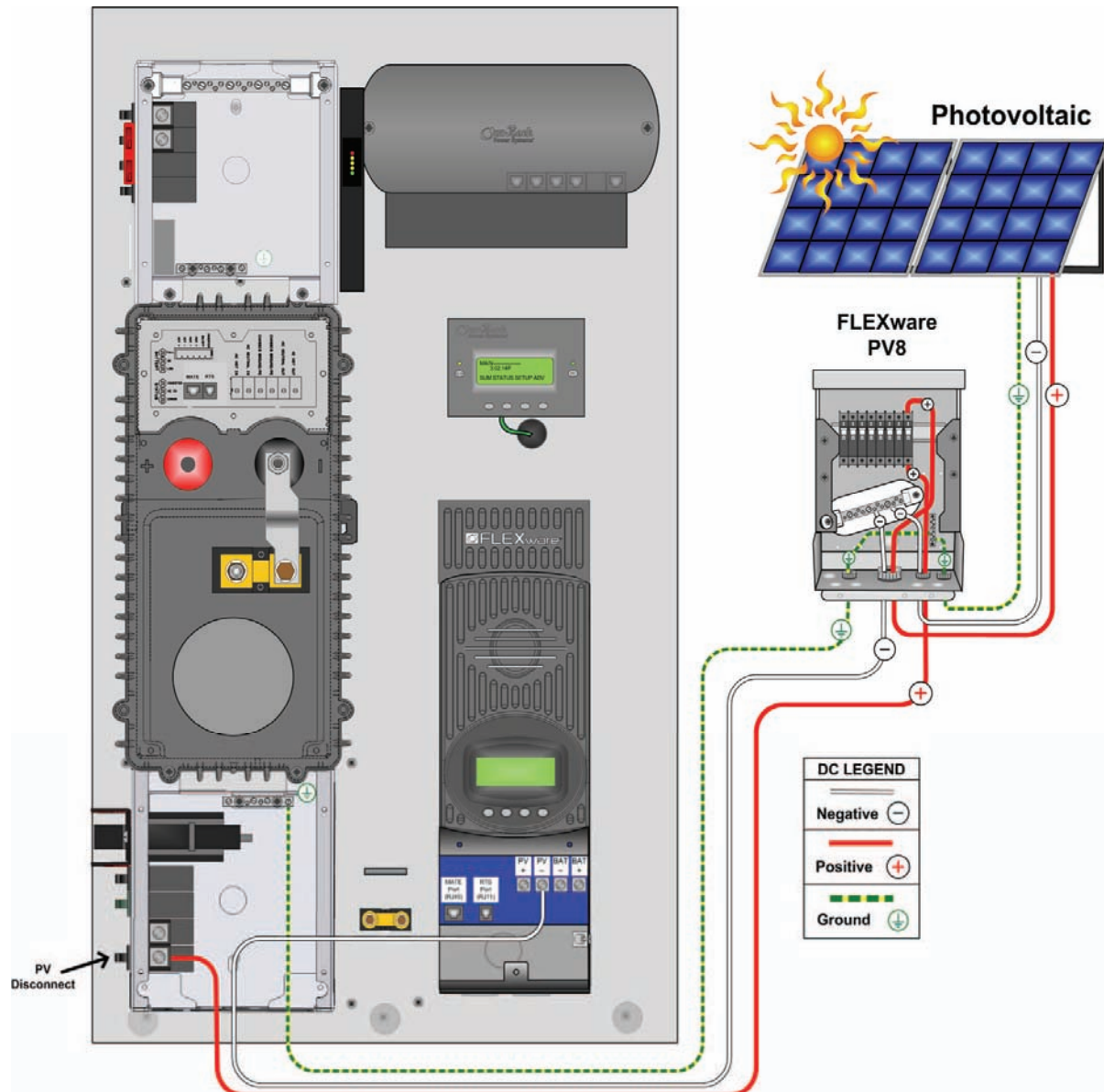

Internal components shown may vary from model to model. Factory wiring is not shown.

Figure 16 PV Connections with a FLEXnet DC Monitor

AC Connections



WARNING: Fire Hazard

Multi-wire branch circuits in residential installations can create a potential fire hazard with inverter installations. Be sure to check for multi-wire branch circuits before making any AC connections and make any changes required to remove the hazard.

Table 5 AC Conductor Size and Torque Requirements

AC Terminal	Minimum Allowed Conductor Size	Maximum Conductor Size	Torque Requirements	Breaker Size
AC IN	#14 AWG (2.1 mm ²)	1/0 AWG (53.5 mm ²)	35 in-lb (4 Nm)	60 Aac
AC OUT	#14 AWG (2.1 mm ²)	1/0 AWG (53.5 mm ²)	35 in-lb (4 Nm)	60 Aac
Neutral Bus Bar	#14 AWG (2.1 mm ²)	1/0 AWG (53.5 mm ²)	35 in-lb (4 Nm)	N/A

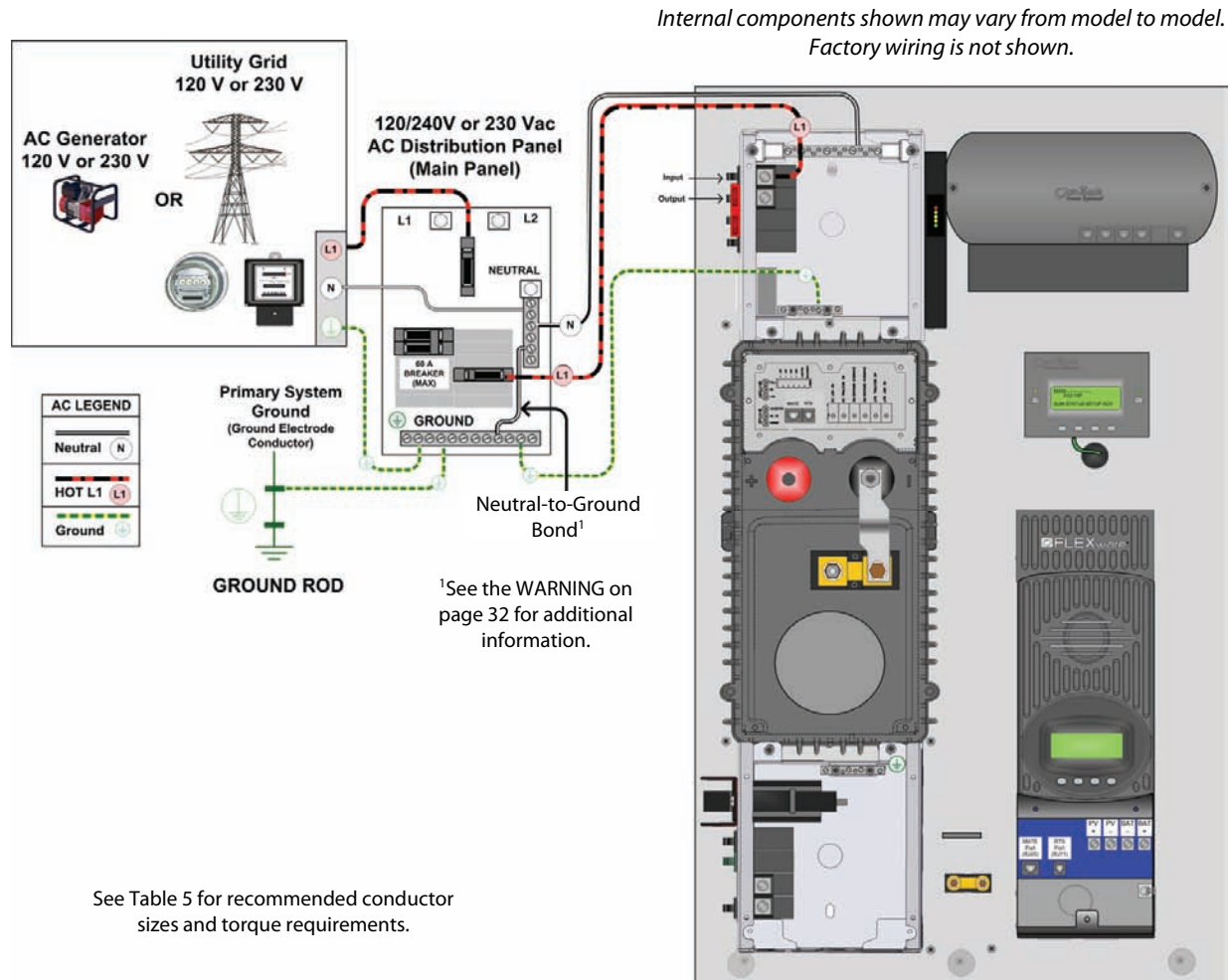

See Table 5 for recommended conductor sizes and torque requirements.

Figure 17 AC IN Connections



WARNING: Shock Hazard

Ensure there is only one Neutral-to-Ground Bond in the system. The FLEXpower ONE comes with a Neutral-to-Ground Bond installed. If a Neutral-to-Ground bond exists elsewhere in the system (e.g., in the main panel, or a generator), the Neutral-to-Ground Bond in the FLEXpower ONE AC Enclosure will need to be removed. See Figure 18. Check local code for specific requirements.

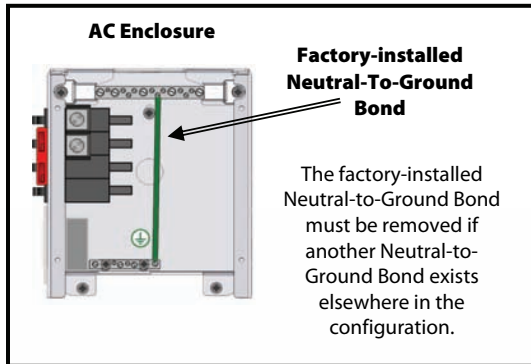

*Internal components shown may vary from model to model.
Factory wiring is not shown.*

See Table 5 on page 32 for recommended conductor sizes and torque requirements.

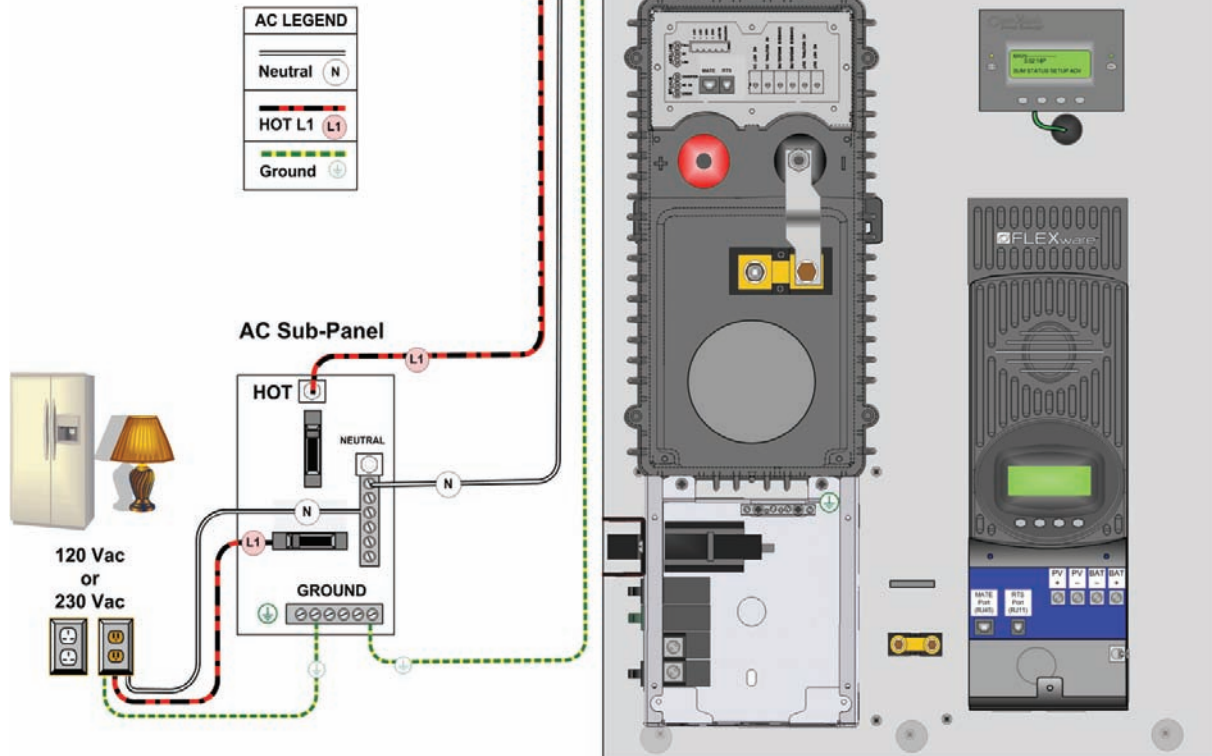

Figure 18 AC OUT Connections

Functional Test/Commissioning

Pre-startup Procedures

1. Double-check all wiring connections.
2. Inspect the enclosure to ensure no tools or debris has been left inside.

Energize/Startup

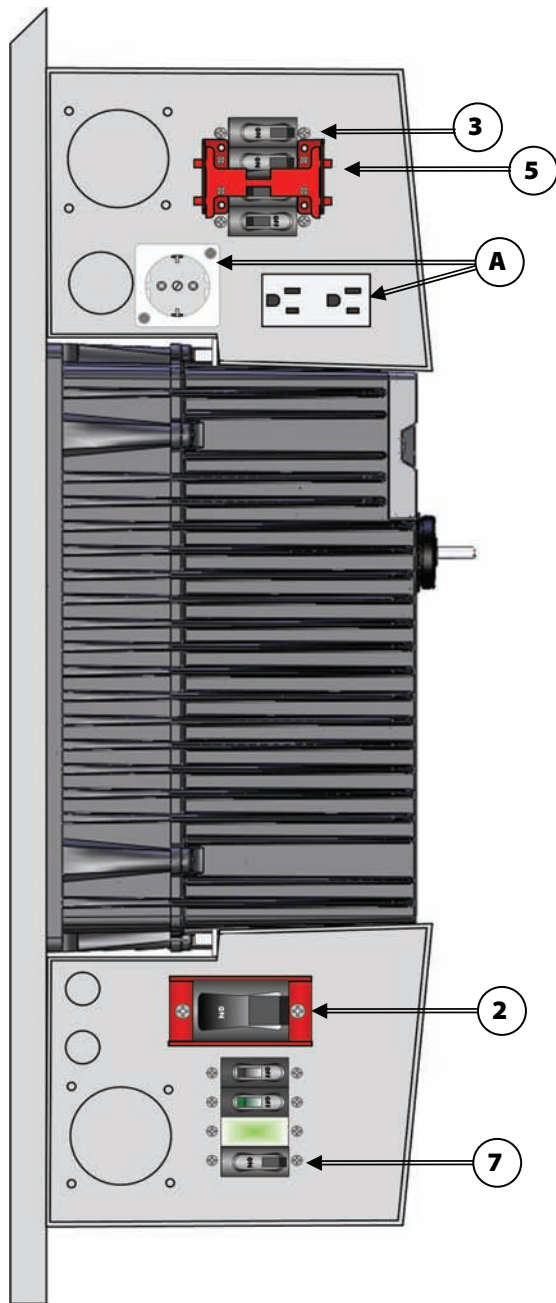

Figure 19 Energize Procedures

1. Using a digital volt-meter (DVM), verify 24 or 48 Vdc on the Battery terminals (i.e., place DVM leads on **1+** and **1-** in Figure 20). Confirm that the voltage is correct for the inverter model. Confirm the polarity.

CAUTION: Equipment Damage
Incorrect battery polarity will damage the inverter.

2. Close the DC Breakers from the battery bank to the inverter. **2** See Figure 19.
3. Close the AC Output Breakers. **3** See Figure 19.
4. Using a digital voltmeter, verify 120 Vac on the AC Breakers (i.e., place voltmeter leads on **4+** and **4-** in Figure 20).
5. Close the AC Input Breakers. **5** See Figure 19.
6. Using a digital voltmeter, verify 120 Vac on the AC Breakers (i.e., place voltmeter leads on **6+** and **6-** in Figure 20).
7. Close the PV input Breakers. **7** See Figure 19.
8. Using a digital voltmeter, verify the voltage on the PV terminal does not equal zero (i.e., place voltmeter leads on **8+** and **8-** in Figure 20).
9. Connect a small AC load and test for proper functionality.

A **Outlets are model-dependent.**
120 V systems will have a 120V outlet,
230 V Systems will have a 230 V outlet.

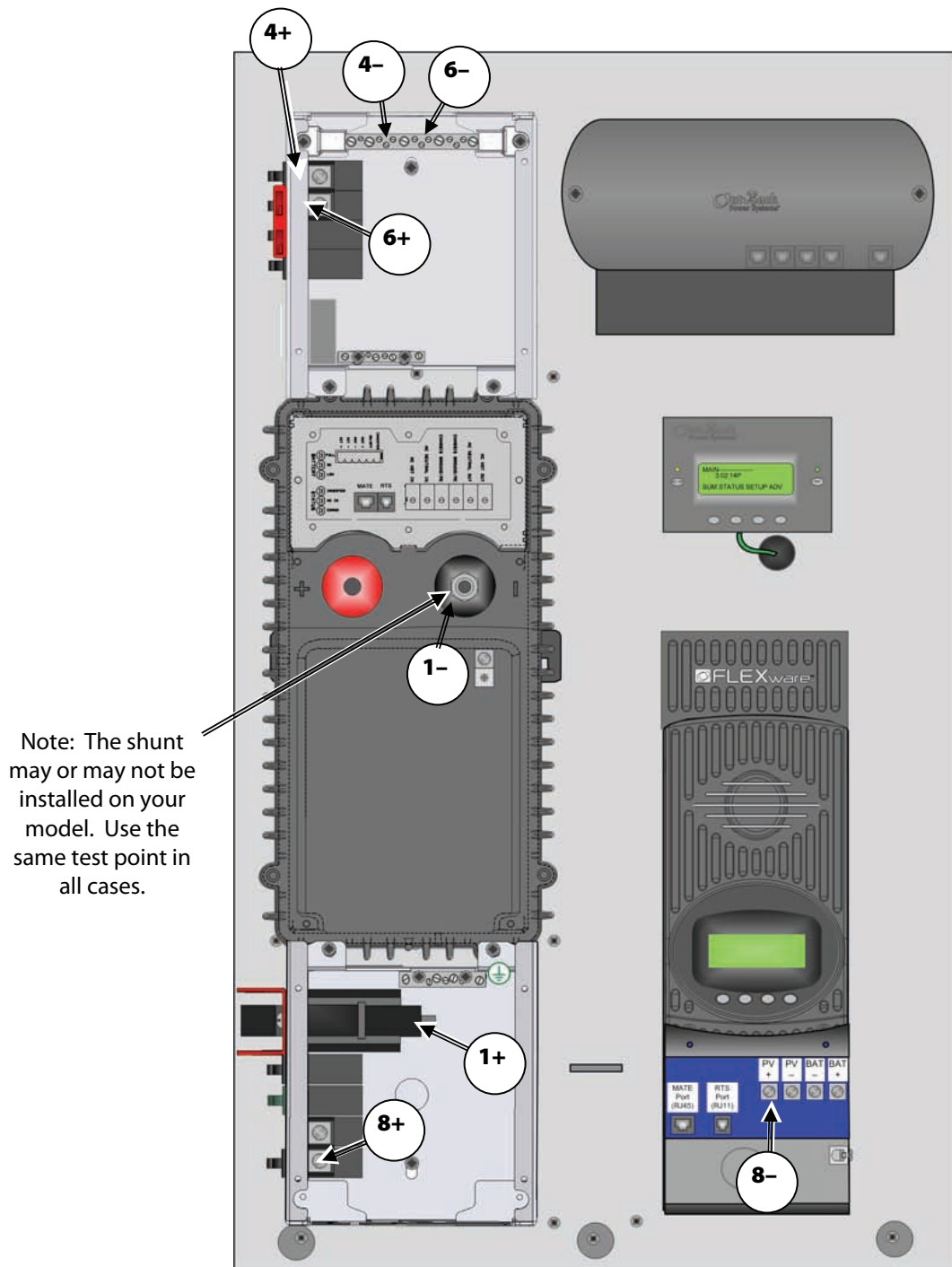
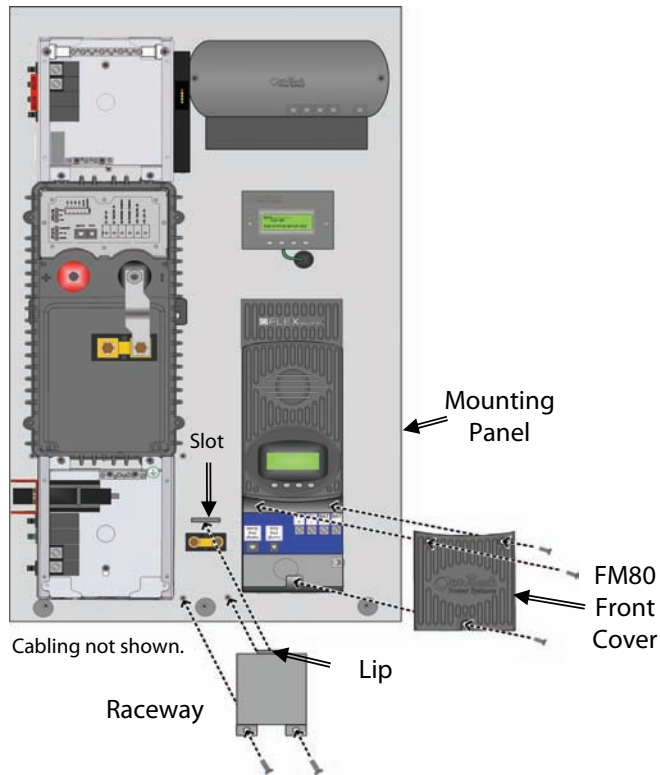

Figure 20 Functional Test Points for Energizing Systems

Reassembling the Enclosures



To Replace the Raceway:

1. Slip the lip on the Raceway into the slot on the mounting panel.
2. Align the holes on the bottom of the Raceway with the holes provided on the mounting panel.
3. Secure the Raceway in place with the screws provided.

To Replace the FLEXmax 80 Front Cover:

1. Align the holes on the FM80 Front Cover.
2. Secure the FM80 Front Cover in place with the screws provided.

Figure 21 Replacing the Raceway and FLEXmax 80 Front Cover

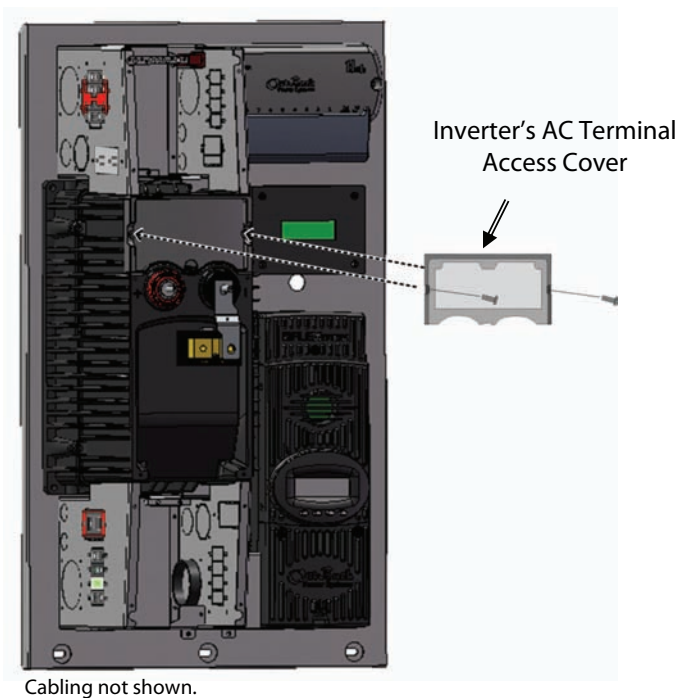

To Replace the Inverter's AC Terminal Access Cover:

1. Align the holes on the sides of the cover with the holes on the inverter.
2. Secure the cover in place with the screws provided.

Figure 22 Replacing the Inverter's AC Terminal Access Cover

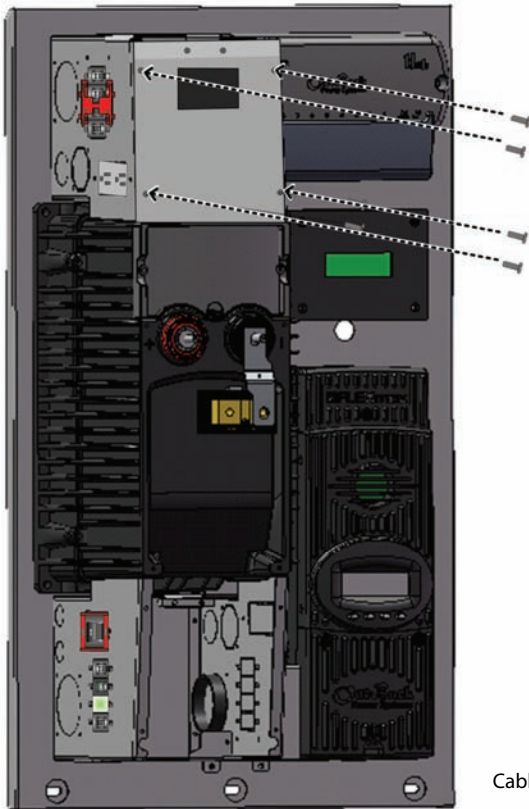

The Front Cover of the AC Enclosure will not be completely removed due to the surge protector cabling. Work with care not to damage the surge protector or dislodge the cabling as you replace the Front Cover.

To Replace the Front of AC Enclosure:

1. Align the holes (x4) in the enclosure front cover with the holes in the chassis.
2. Replace the screws (x4) removed in the beginning.

Cabling not shown.

Figure 23 Replacing the AC Enclosure Front Cover

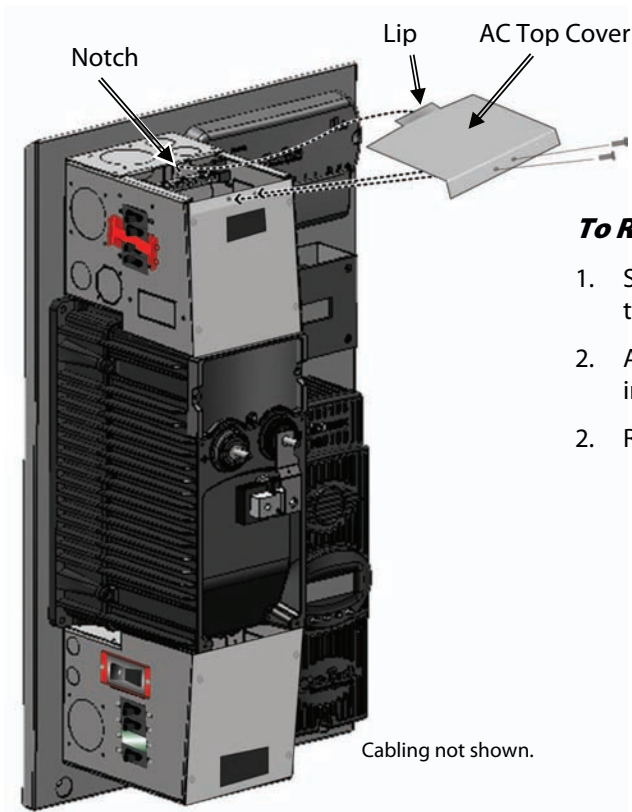

To Replace the Top of AC Enclosure:

1. Slip the Lip on the AC Top Cover into the notch in the chassis.
2. Align the holes (x2) in the top cover with the holes in the front cover.
2. Replace the screws (x2) removed in the beginning.

Cabling not shown.

Figure 24 Replacing the AC Enclosure Top Cover

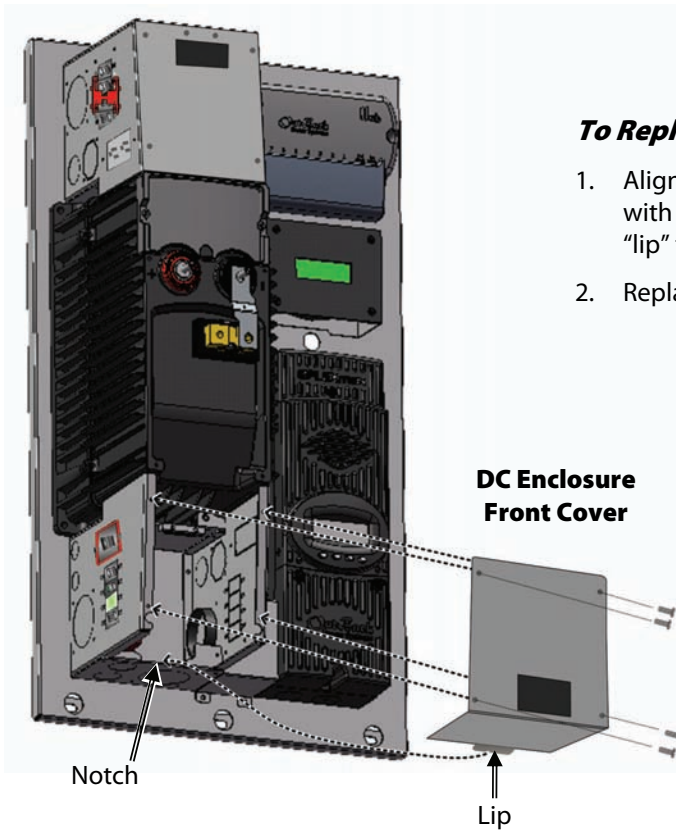

To Replace the DC Enclosure Front Cover:

1. Align the holes in the DC Enclosure Front cover with the holes in the chassis. Ensure that the "lip" fits into the notch in the chassis.
2. Replace the screws removed in the beginning.

Cabling not shown.

Figure 25 Replacing the DC Enclosure Front Cover

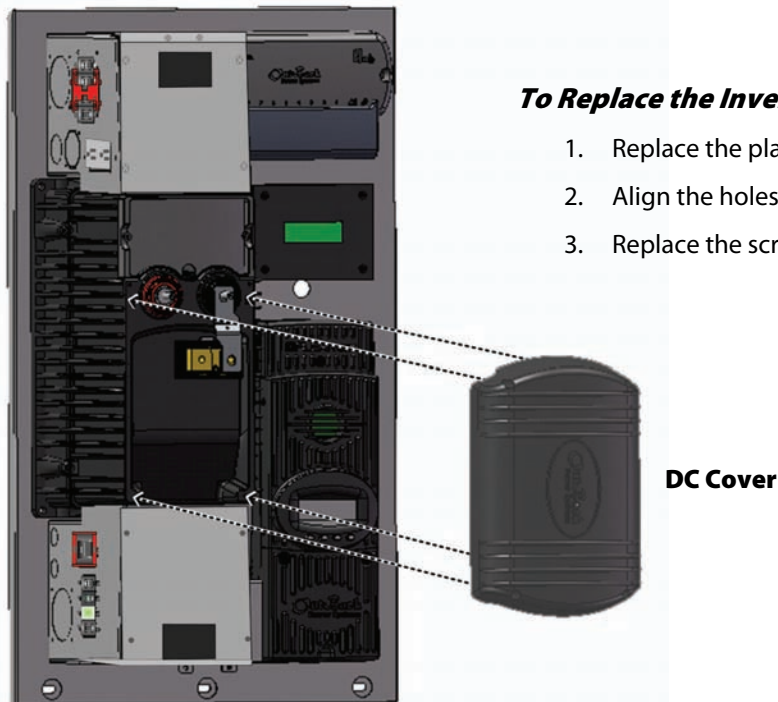

To Replace the Inverter's DC Cover:

1. Replace the plastic Battery Terminal Covers.
2. Align the holes in the DC Cover as shown.
3. Replace the screws removed in the beginning.

Cabling not shown.

Figure 26 Replacing the DC Cover



Operation

Setting Basic Parameters



IMPORTANT:

This section assumes that the operator is familiar with the basic operation and navigation of the installed components. *Detailed information about component settings is provided in each of the components respective manuals.*

Although some of the programming will be pre-set at the factory (i.e., grid-tie features for grid-interactive units, charging for 24 or 48 Vdc battery banks), the following parameters may need to be adjusted on-site depending on the configuration of the system.

MATE2 Settings

The MATE2 may need to have basic operational parameters set prior to first use. The time, date, and display features are available in the Setup Screen for the MATE2. For instructions on setting the time and date settings, follow the menu maps on page 40 and 41.

Inverter Settings

The VFX/GVFX Series inverter/charger only has one AC input, therefore, the selected input will need to be identified—Grid or Generator. It will also be necessary to set the AC Input Current Limit for either the Grid (60 Aac Max) or Generator (60 Aac Max). For instructions for setting the AC Input Current, follow the menu map on page 42. For instructions on setting other inverter features, see the MATE Installation and User Manual.

Charger Settings

Charging settings include charging current limit and the voltage and time limits for each stage of the charge cycle (e.g., absorb, float). These parameters will be pre-set at the factory. However, these settings may still need to be adjusted by individual installer depending on the battery manufacturer's recommendations.

Charger settings are located in the FX Advanced Menu and/or the FLEXmax 80 Charge Controller menu. The configuration will dictate which device will need adjustment.

➤ For instructions on accessing the **FX Advanced Menu**, see page 43 in this manual.

➤ **FLEXnet DC Monitor Settings**

If the FLEXnet DC Monitor is installed, the Battery Amp-hours and Return Amps will need to be set. For instructions on setting these two parameters, see page 44 in this manual.

➤ **FLEXmax 80 Charge Controller Settings**

Charging parameters will be dependent on the type and size of batteries and the size of the PV array. Basic parameters for either 24 Vdc or 48 Vdc will be pre-set at the factory. Consult the battery manufacturer for charging recommendations. Refer to the FLEXmax 80 Installation Manual for additional programming information.

Setting Time, Date & Display on the MATE2



IMPORTANT:

The following information assumes the installer is familiar with the basic operation of a MATE2 System Controller and Display. If the installer is not familiar with basic operation, please refer to the MATE Installation and User Manual for general information.

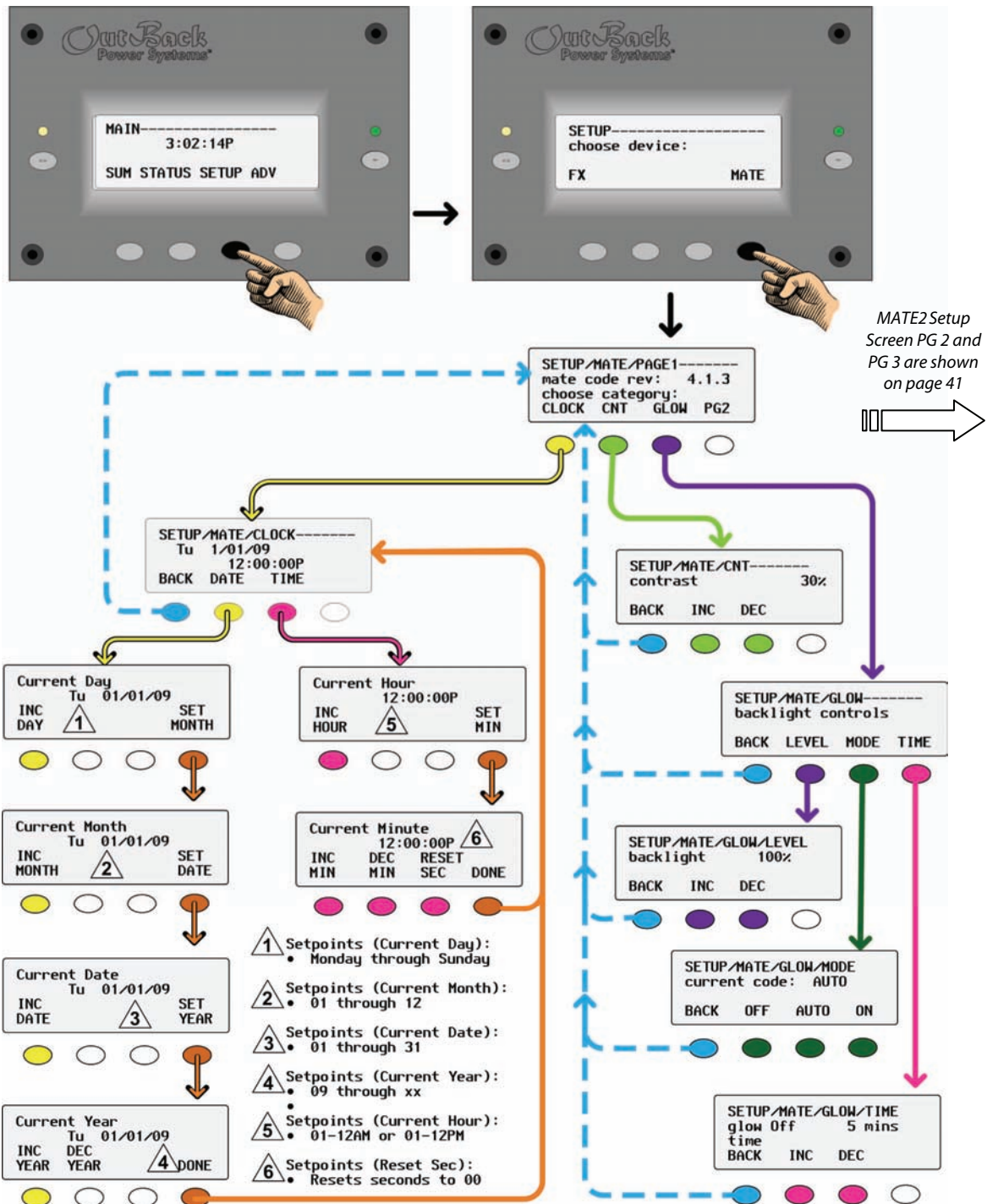

Figure 27 MATE2 Setup Screen (Page 1)

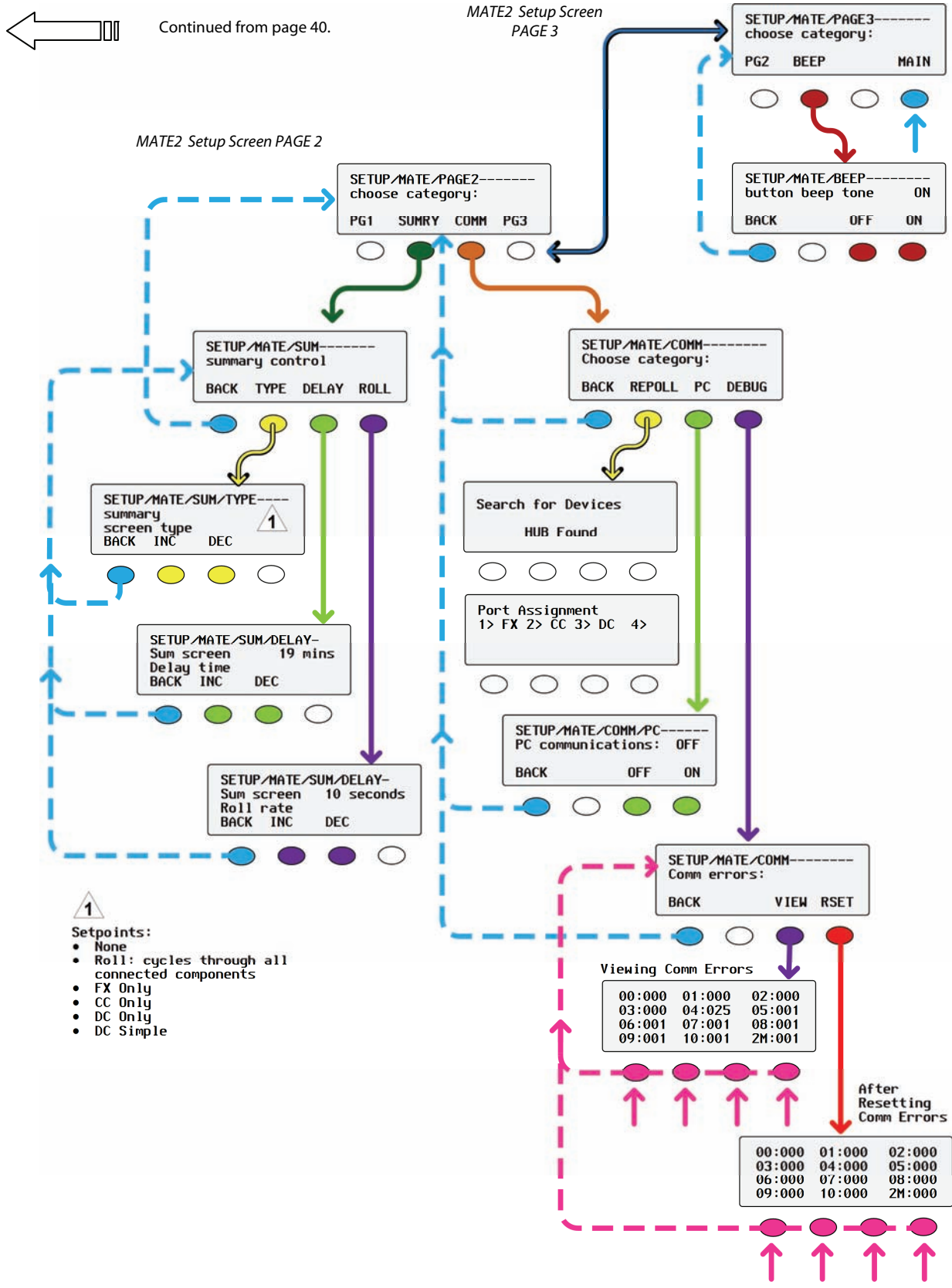

Figure 28 MATE2 Setup Screen (Page 2 and 3)

Selecting the AC Source and AC Input Limit on the Inverter

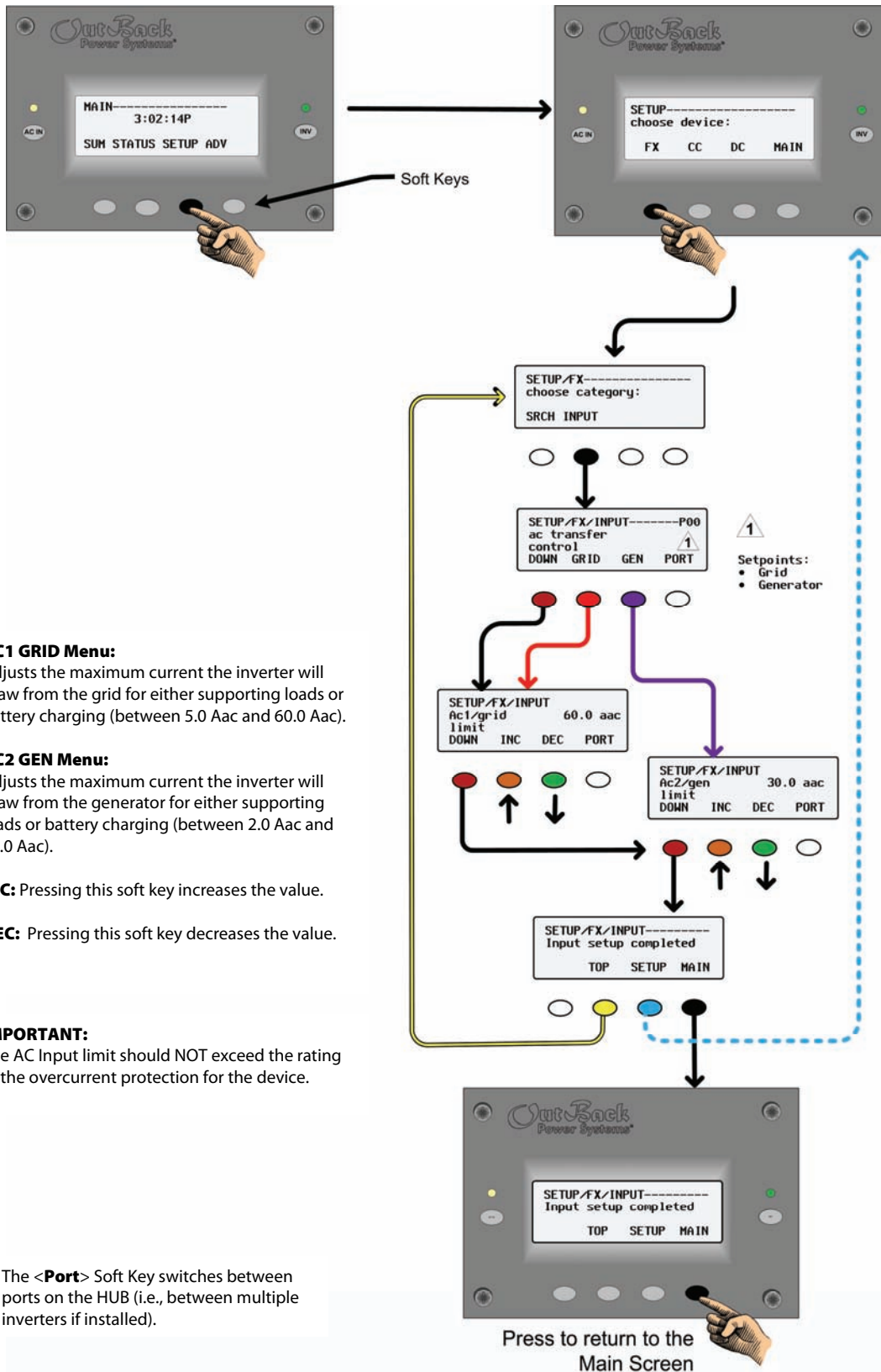

Figure 29 Inverter Setup Screen – Selecting AC Source

Accessing the Advanced Menu

In most cases, the charging parameters set at the factory will work for most systems. However, if changes are required, these parameters are set using the Advanced Menu system. This includes the charging input current limit and the voltage and time limit for each stage of charging.



IMPORTANT:

- Making changes to the Advanced Settings could adversely affect current system performance. Only make changes to the factory default settings if you are qualified to do so.

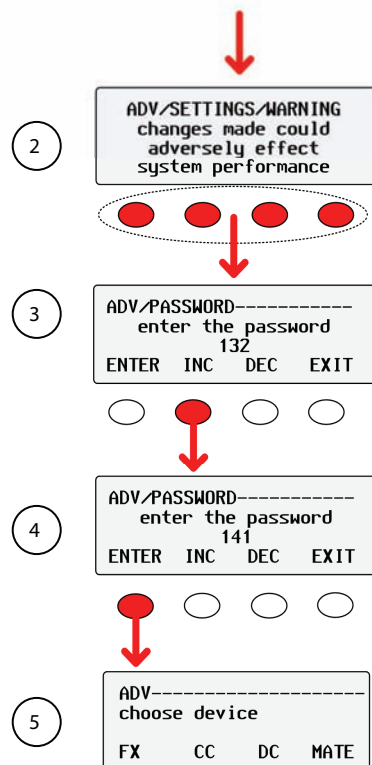
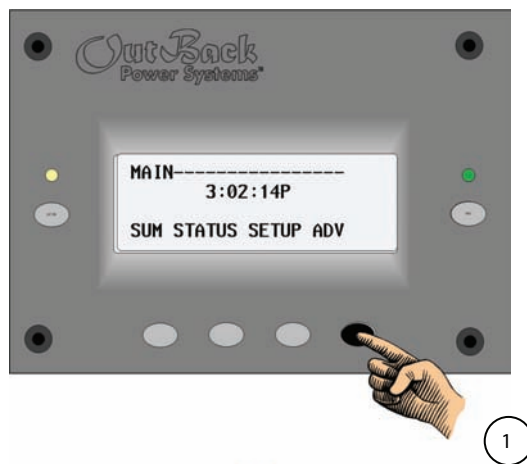

IMPORTANT:

A password will be required to access the Advanced Menu system.
This password cannot be changed.

The system password is

141

Figure 30 Accessing the Advanced Menus

Setting Battery Amp-Hours and Return Amps using the FLEXnet DC Monitor

If a FLEXnet DC Monitor is installed in the configuration, the following parameters will need to be set.

- Battery Amp-Hours refers to the total amp-hour capacity of the battery bank (not just amp-hour rating of the individual batteries within the battery bank).
- Return Amps is the low limit to which an absorption current must decrease, while still maintaining the absorption voltage, before the battery is judged to be full. Use the battery manufacturer's specifications or 2% of the battery bank capacity.

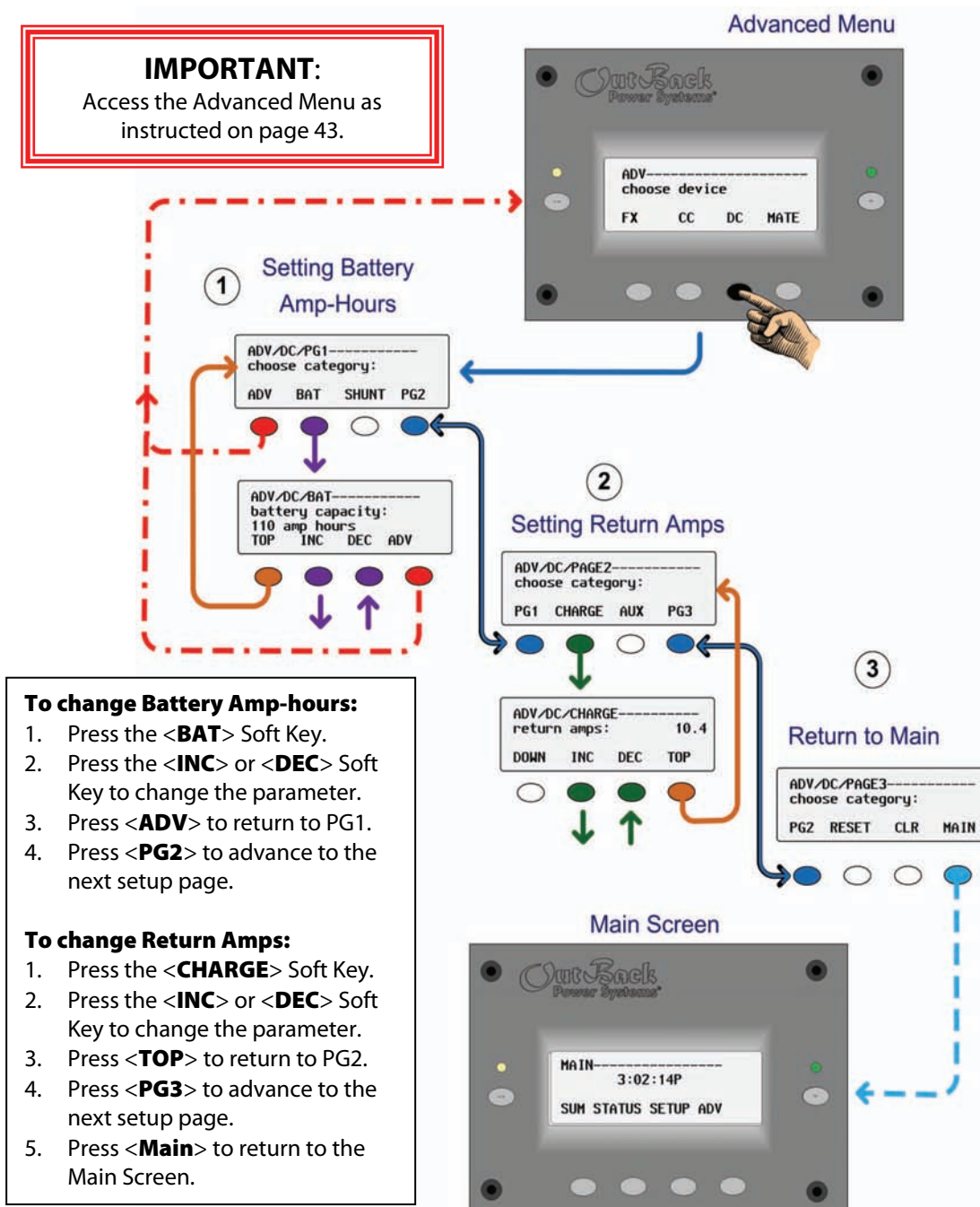
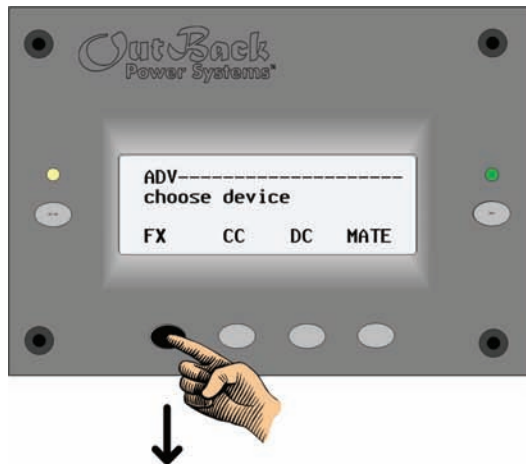

Figure 31 Setting Battery Amp-hours and Return Amps

Setting Charging Parameters

If changes need to be made to charging parameters, follow the menu map below.

IMPORTANT:
Access the Advanced Menu as instructed on page 43.



- To Set Charging Limits:**
1. Press the <CHGR> Soft Key.
 2. Press the <INC> or <DEC> Soft Key to change the parameter.
 3. Press <DOWN> to advance to the next parameter.
 4. Continue pressing <DOWN> to cycle through all the settings.

IMPORTANT:
Consult the Battery Manufacturer for exact charging requirements.



WARNING: Explosion Hazard
NEVER equalize a sealed battery.

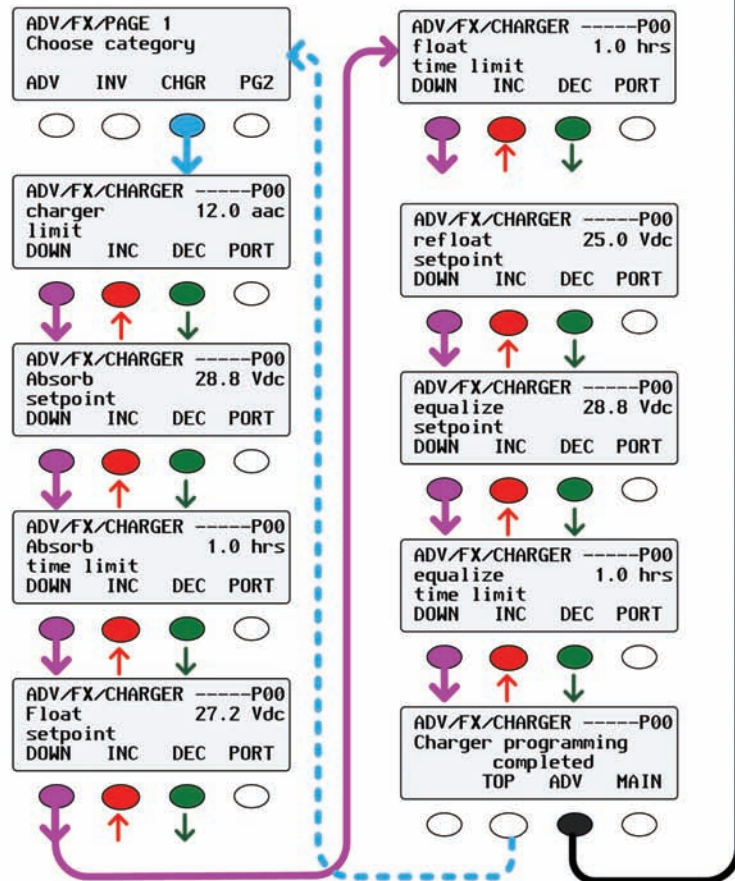

When the screen reads "Charger Programming Completed",

- press <TOP> to return to the "Choose Category" Screen, or
- press <ADV> to return to the "Choose Device" Screen, or
- press the <MAIN> soft key to return to the Main page.

Figure 32 Setting Input Source and Current Limit

De-energize/Shutdown

	<p>WARNING: Lethal Voltage</p> <p>Review the system configuration to identify all possible sources of energy. Ensure ALL sources of power are disconnected before performing any installation or maintenance on this equipment. Confirm that the terminals are de-energized using a validated voltmeter (rated for a minimum 1000 Vac and 1000 Vdc) to verify the de-energized condition.</p>
	<p>WARNING: Burn Hazard</p> <p>Internal parts can become hot during operation. Do not remove the cover during operation or touch any internal parts. Be sure to allow them sufficient time to cool down before attempting to perform any maintenance.</p>

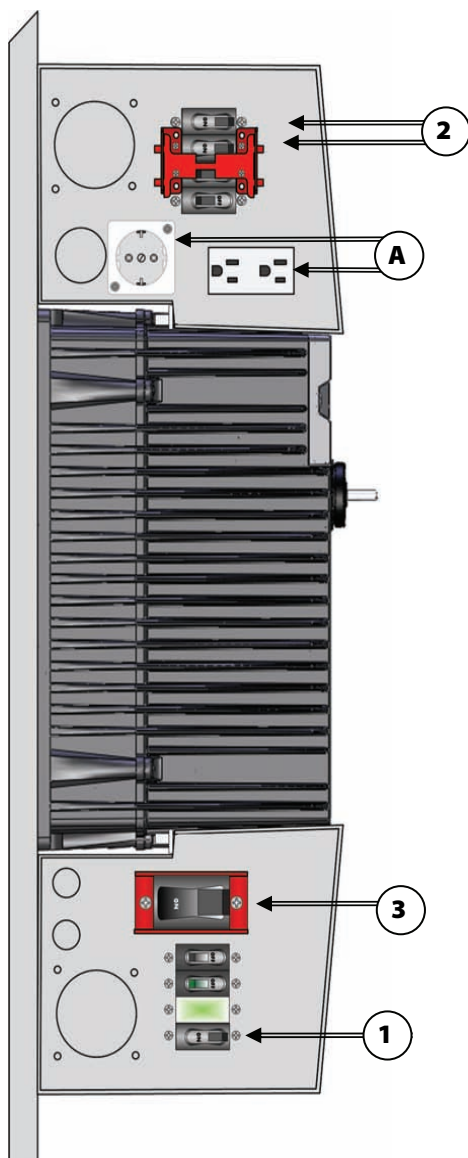

1. Open the PV Breakers. (1)
2. Open the AC Breakers. (2)
3. Open the DC Breaker for the Battery. (3)
4. Using a digital volt-meter, verify 0 Vdc on the Battery terminals of the Inverter (i.e., place voltmeter leads on (4+) and (4-) in Figure 34 on page 47).
5. Using a digital volt-meter, verify 0 Vdc on the PV terminal (i.e., place voltmeter leads on (5+) and (5-) in Figure 34 on page 47).
6. Using a digital volt-meter, verify 0 Vac on the AC Breakers (i.e., Place voltmeter leads on (6+) and (6-) in Figure 34 on page 47).

(A) Outlets are model-dependent. 120 V systems will have a 120V outlet, 230 V Systems will have a 230 V outlet.

Figure 33 Shutdown Procedures

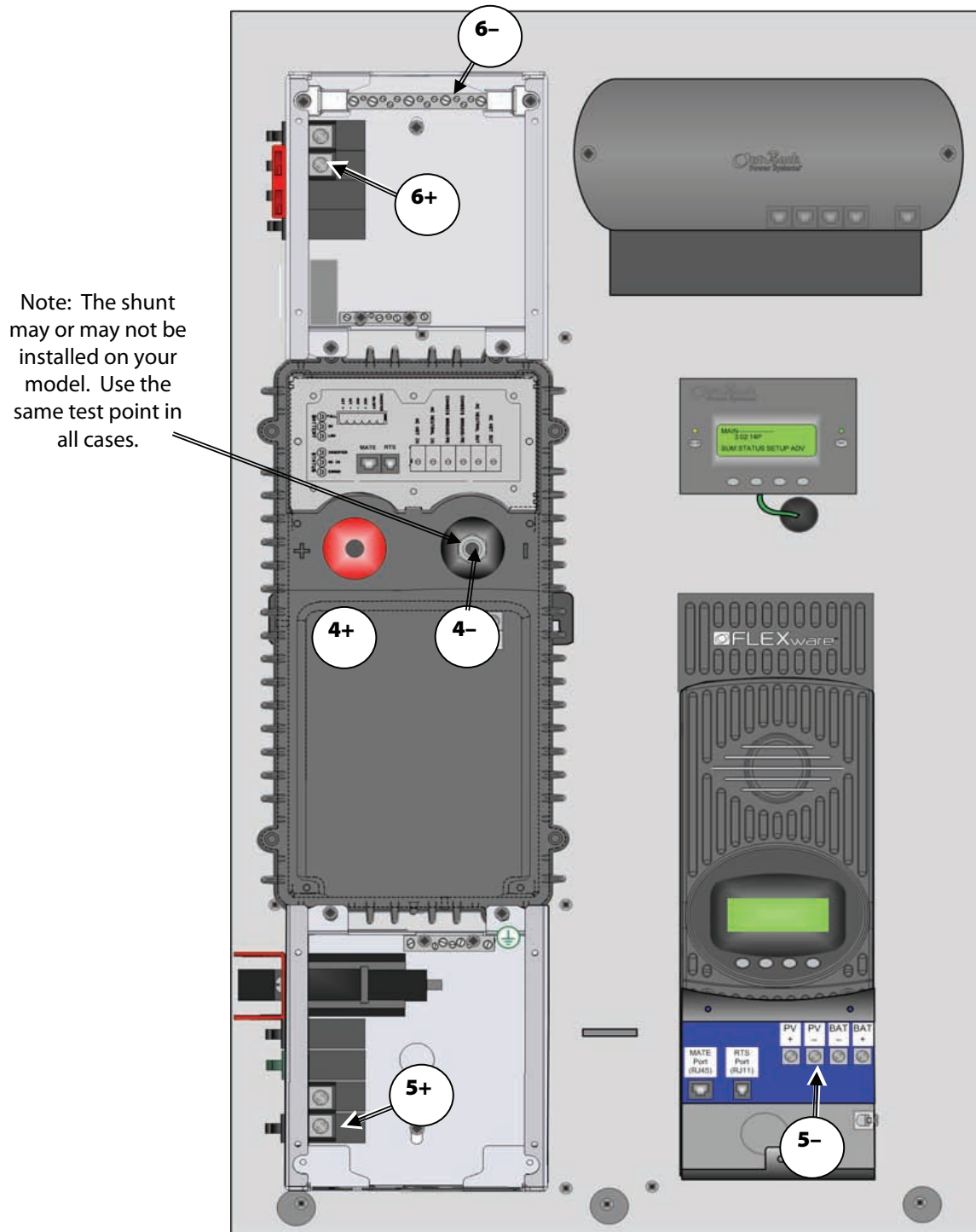

Figure 34 Functional Test Points for De-Energizing Systems



Specifications

Feature Matrix

The following Matrix shows the FLEXpower ONE models that are described in this manual.

Table 6 Feature Matrix

MODEL	INVERTER MODEL	FM80	FLEXnet DC Monitor		HUB	Surge Protector	MATE	GFDI	AC Enclosure		DC Enclosure	
			FN-DC SHUNT A	FN-DC SHUNT B					120 Vac	230 Vac	175A	250A
FP1-1	VFX3524	X	X	X	X	X	X	X				X
FP1-2	VFX3648	X	X	X	X	X	X	X			X	
FP1-3	GVFX3524	X	X	X	X	X	X	X				X
FP1-4	GVFX3648	X	X	X	X	X	X	X			X	
FP1-5	VFX3024E	X	X	X	X	X	X		X			X
FP1-6	VFX3048E	X	X	X	X	X	X		X		X	

Electrical Specifications, 120 Vac/60 Hz Models

Product Name	FP1-1	FP1-2	FP1-3	FP1-4	
Inverter Model	VFX3524	VFX3648	GVFX3524	GVFX3648	
Grid-Interactive	No	No	Yes	Yes	
Anti-Islanding Protection	N/A	N/A	UL1741-2005/ IEE1547	UL1741-2005/ IEE1547	
Total Harmonic Distortion	Sell Current	N/A	< 5%	< 5%	
	Invert Voltage	N/A	2% Typical	2% Typical	
Output Waveform	True Sine Wave				
Battery Voltage	Nominal	24 Vdc	48 Vdc	24 Vdc	48 Vdc
	Operating Range	20-30 Vdc	40-60 Vdc	20-30 Vdc	40-60 Vdc
Recommended Minimum Battery Capacity	200 Amp-hours	100 Amp-hours	200 Amp-hours	100 Amp-hours	

For Models with FM80 Charge Controller:

Maximum PV Array Wattage	2000 Wdc _{STC}	4000 Wdc _{STC}	2000 Wdc _{STC}	4000 Wdc _{STC}
PV Input Voltage Range	50-150 V _{OC}	25-150 V _{OC}	50-150 V _{OC}	25-150 V _{OC}
PV Operating Voltage Range	50-145 Vdc	25-145 Vdc	50-145 Vdc	25-145 Vdc
PV Maximum Open Circuit Voltage	150 V _{OC} including local temperature correction factor			
PV Maximum Short Circuit Current	64 A I _{SC}			

Protection

AC and DC Surge Protection	MOV Current Diversion with LED Warnings
PV Ground Fault Protection	80 Adc Breaker (Detection >0.5 A)

For Models with FLEXnet DC Battery Monitor:

State of Charge Display	5-LED Bar Graph, or 1% - 100% scale, using MATE2
Battery Capacity Range	100 to 10,000 Amp-hours
Current Resolution	0.1 Amps DC
Shunt A	500 amp, 50 mV
Shunt B	100 amp, 10 mV
Certifications	ETL Listed to UL 1741, CSA 22.2 #107.1
Warranty	5-year limited warranty standard/Optional 10-year warranty

Mechanical Specifications, 120 Vac/60 Hz Models

Product Name	FP1-1	FP1-2	FP1-3	FP1-4
Part Numbers	VFX3524	VFX3648	GVFX3524	GVFX3648
Dimensions (H x W x D)	33.50" (85.09 cm) x 19.75" (46.26 cm) x 12.87" (32.68 cm)			
Weight	98 lb (44.5 kg)			
Enclosure and Mounting Plate Materials	Aluminum			
Mounting	Wall Mount (Bracket Included)			
AC Inputs	60 Aac Bypass Assembly			
AC Outputs	20 Aac Outlet and Breaker			
AC and PV terminals	Accepts #12 AWG to 1/0 AWG			
Charge Controller Terminals	Accepts #12 AWG to 1/0 AWG			
Integrated Communications	MATE2 for system operation information; FLEXnet DC Battery Monitor for battery information			

Electrical Specifications, 230 Vac/50 Hz Models

Product Name		FP1-5	FP1-6
Inverter Model		VFX3024E	VFX3048E
Output Waveform		True Sine Wave	
Battery Voltage	Nominal	24 Vdc	48 Vdc
	Operating Range	20-30 Vdc	40-60 Vdc
Recommended Minimum Battery Capacity		200 Amp-hours	100 Amp-hours

For Models with FM80 Charge Controller:

Maximum PV Array Wattage	2000 Wd _{CSTC}	4000 Wd _{CSTC}
PV Input Voltage Range	25-150 V _{OC}	50-150 V _{OC}
PV Operating Voltage Range	25-145 Vdc	50-145 Vdc
PV Maximum Open Circuit Voltage	150 V _{OC} including local temperature correction factor	
PV Maximum Short Circuit Current	64 A I _{SC}	

Protection

AC and DC Surge Protection	MOV Current Diversion with LED Warnings
PV Ground Fault Protection	80 Adc Breaker (Detection >0.5 A)

For Models with FLEXnet DC Battery Monitor:

State of Charge Display	5-LED Bar Graph, or 1% - 100% scale, using MATE2
Battery Capacity Range	100 to 10,000 Amp-hours
Current Resolution	0.1 Amps DC
Shunt A	500 amp, 50 mV
Shunt B	100 amp, 10 mV
Warranty	5-year limited warranty standard/Optional 10-year warranty

Mechanical Specifications, 230 Vac/50 Hz Models

Product Name	FP1-5	FP1-6
Part Numbers	VFX3024E	VFX3048E
Dimensions (H x W x D)	33.50" (85.09 cm) x 19.75" (46.26 cm) x 12.87" (32.68 cm)	
Weight	98 lb (44.5 kg)	
Enclosure and Mounting Plate Materials	Aluminum	
Mounting	Wall Mount (Bracket Included)	
AC Inputs	30 Aac Bypass Assembly	
AC Outputs	16 Aac Outlet and Breaker	
AC and PV terminals	Accept #12 AWG to 1/0 AWG. Torque: 35 in-lb (4 Nm)	
Charge Controller Terminals	Accept #12 AWG to 1/0 AWG. Torque: 35 in-lb (4 Nm)	
Integrated Communications	MATE2 for system operation information; FLEXnet DC Battery Monitor for battery information	

Surge Protector

The FLEXware Surge Protector is designed to protect the FLEXpower ONE's sensitive components from excessively high voltages (e.g., electrical storms). Thermally-fused metal oxide varistors (MOVs) limit ("clamp") these voltages and transfer the resulting current to a lower-voltage port. The FLEXware Surge Protector features ACTIVE and ERROR LEDs for the DC, AC IN, and AC OUT circuits. The Surge Protector is located in the FLEXpower ONE's AC wiring compartment.



The FLEXware Surge Protector shunts excess current from:

- DC+ (to GROUND)
- AC HOT IN (to GROUND)
- AC NEUTRAL IN (to GROUND)
- AC HOT OUT (to AC NEUTRAL OUT)
- AC HOT OUT (to GROUND)
- AC NEUTRAL OUT (to GROUND)



LEDs

- ACTIVE LEDs are yellow. If these LEDs are on, power is present in that circuit. It is normal for these LEDs to be on.
- ERROR LEDs are red. A red ERROR light indicates a problem. The LED means a significant surge has damaged the FLEXware Surge Protector, and protection in that circuit is compromised. Although decreased protection remains, it is recommended that the FLEXware Surge Protector be replaced at this time, before further damage occurs. Further damage to the Surge Protector will eventually lead to damage to other FLEXpower ONE components.
- For an ERROR LED to turn on, its circuit must be powered; its ACTIVE LED will also glow. Note that if the circuit is not powered, the ERROR LED will not indicate a problem even if one is present.

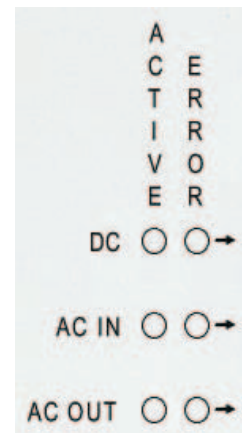

Specifications

Nominal Voltage	Voltage Protection	Max Surge Current	Energy Rating	Frequency	Protection Type	Protected Circuit
120-240 Vac 12-48 Vdc	390 Vac 150 Vdc	30 kA per circuit	2500 Joules	50/60 Hz	Thermally Fused MOV	x2 AC x1 DC

Replacement Boards

Replacement boards for the Surge Protector are available in the event that a power surge damages the one currently installed. To obtain a replacement board, contact your local OutBack dealer. The OutBack designation for a replacement board is FW-SP-FP1.

Renewable Energy Input & Storage

PV Sizing

Single charge control systems can support photovoltaic arrays with the following specifications. Dual charge controller systems can handle 2 arrays with the following specifications.

Maximum Array Size

- 4,000 W_{STC} on 48 Vdc system, 2,000 W_{STC} on 24dc system
- 145 Vdc (150 V_{OC} including local temperature correction factor per NEC 690.7)
- 64 A I_{SC} maximum PV array current per NEC 690.8

A PV string-sizing tool is available on the following website link:

- http://outbackpower.com/resources/string_sizing_tool/

Battery Bank Sizing

In general, the size of the loads (watts) and the required backup period (hours) will determine best size (amp-hour capacity) for the battery bank.

Running Time and Size

The battery bank's size determines the length of time the inverter can supply AC output power. The larger the bank, the longer the inverter can run and the longer the recharge time.

Depth-of-Discharge

The battery bank should be designed so the batteries do not discharge more than 50-60% of their capacity on a regular basis. Discharging up to 80% is acceptable on a limited basis, such as a prolonged utility outage. Totally discharging a battery can reduce its effective life or permanently damage it. Consult the battery manufacturer for specific depth-of-discharge recommendations.

Days of Autonomy

Days of autonomy may vary depending upon the availability of the charging source(s), the critical nature of the load and other factors. If the system is to be powered by renewable energy sources such as solar, determine the appropriate number of days of autonomy by allowing for cloudy weather as well as other seasonal variations in available energy.

Back up power systems which use utility power for recharging should use the estimated number of days of maximum power outage for determining days of autonomy.

Amp-Hour Requirements

Amp-hour requirements will vary with each installation depending on the loads that are connected and the desired amount of time for those loads to be supported in the event that utility power is unavailable

Amp-hour Capacity

Deep cycle batteries have a capacity measured in amp-hours. Amp-hours are a measure of current flow over time. An amp-hour figure is derived by multiplying current (amperes) by the amount of time the current flows (hours). This applies equally to the amount you take out of a battery (discharging) or the amount you put into it (charging).

Discharge Rate

Deep cycle batteries express the amp-hour rating as "at the x-hour rate". This is an average rate of current flow that would take x number of hours to discharge the batteries. Common amp-hour figures are at the 6-hour rate, the 20-hour rate, and the 100-hour rate. A battery is classified as having fewer amp hours if it is discharged at a faster rate, such as the 6-hour rate. There is an inevitable amount of heat associated with the flow of current through a battery. The higher the amount of current, the greater the amount of heat generated. The heat is energy which is no longer available to the battery to power loads. Hence, at a higher discharge rate, the batteries effectively have fewer amp-hours available. Generally, the 20-hour rate is the most common one.

Estimating Amp Hours

To estimate the battery bank requirements, first calculate the amount of power to be drawn from the batteries during the period of autonomy. This power draw is then translated into amp hours (Ah)—the unit of measure to express deep-cycle battery capacity.

Amp-hours are calculated multiplying the current drawn by the load by the length of time it will operate.

Watts to Amps

To calculate amps when the power consumption is expressed in watts, use the following equation:

$$A = W/V$$

where W = watts and V = volts DC

For example:

A 100 watt light bulb will draw approximately 8.33 amps from a 12-volt battery system.

$$8.33 = 100 / 12$$

If the light runs for three hours it will consume (8.33 x 3) or 25 Ah of power.



IMPORTANT:

For these calculations, do not use the AC amp rating of a device. AC amps are measured on a different scale and will not give correct results.

Time and Power

The length of time a load is operated will affect the power draw. In some cases, an appliance which draws a large wattage may not consume as many amp-hours as a load drawing fewer watts but running for a longer period of time.

Amps to Watts

All electrical appliances have labels which state their energy consumption. Look for an amps rating on motors and a watts rating on other appliances.

If the label plate has expressed power consumption in AC amps, multiply by volts for the watts required (watts = volts x amps).

Things to consider:

- Motors typically require 3 to 6 times their running current when starting. Check the manufacturer's data sheets for their starting current requirements. If you will be starting large motors from the inverter, increase the battery bank size to allow for the higher start-up current.

- Refrigerators and ice-makers typically run only about 1/3 of the time, therefore, the running wattage is 1/3 of the total wattage of the appliance. Divide the total wattage of the appliance by 3 when determining the battery requirements.

Calculating Amp-Hours

To determine the amp-hours that will be consumed, list the anticipated loads and the length of time they will operate. Use the specifications noted on the labels of each AC load that is to be connected to the system. Determine the number of hours per day and the number of days during the week that the load will be used.

Use the worksheet on page 56 to list the respective values and calculate the amp-hour requirement.

In summary, to calculate the amp-hour requirements:

1. Determine the loads the system will power and enter their wattage.
2. Determine the number of hours (or decimal portion of hours) the appliance is used each day.
3. Determine the number of days the appliance will be used during the week.
4. Multiply Hours x Days for each load identified to determine the watt-hours per week.
5. Add the total watt-hours per week for all loads then divide by 7 to obtain the average total watt-hours per day.
6. Divide the total average per day by the DC nominal voltage.

This figure represents the average amp-hours per day that will be used.

Worksheet for Calculating Battery Bank Size

Use the following worksheet to calculate the battery bank size.

Table 8 Worksheet for Determining Battery Bank Size

Average amp-hours per day (from Table 7)	
Divided by inverter efficiency	
Divided by battery efficiency (usually 0.75)	
Adjusted amp-hours per day	
Divided by Depth-of-Discharge (usually 60%)	
Multiplied by days of autonomy	
Battery bank size required	

This page intentionally left blank.



Wiring Configurations

The following wiring configurations are provided as examples only. Actual wiring requirements may vary depending on local electric code. All installations must comply with local electric code.

- FLEXpower ONE with FLEXnet DC Monitor and GFDI
- FLEXpower ONE with FLEXnet DC Monitor Only (No GFDI)
- FLEXpower ONE with GFDI Only (no FLEXnet DC Monitor)
- FLEXpower ONE (no FLEXnet DC Monitor or GFDI)

This page intentionally left blank.

FLEXpower ONE with FLEXnet DC Monitor and GFDI

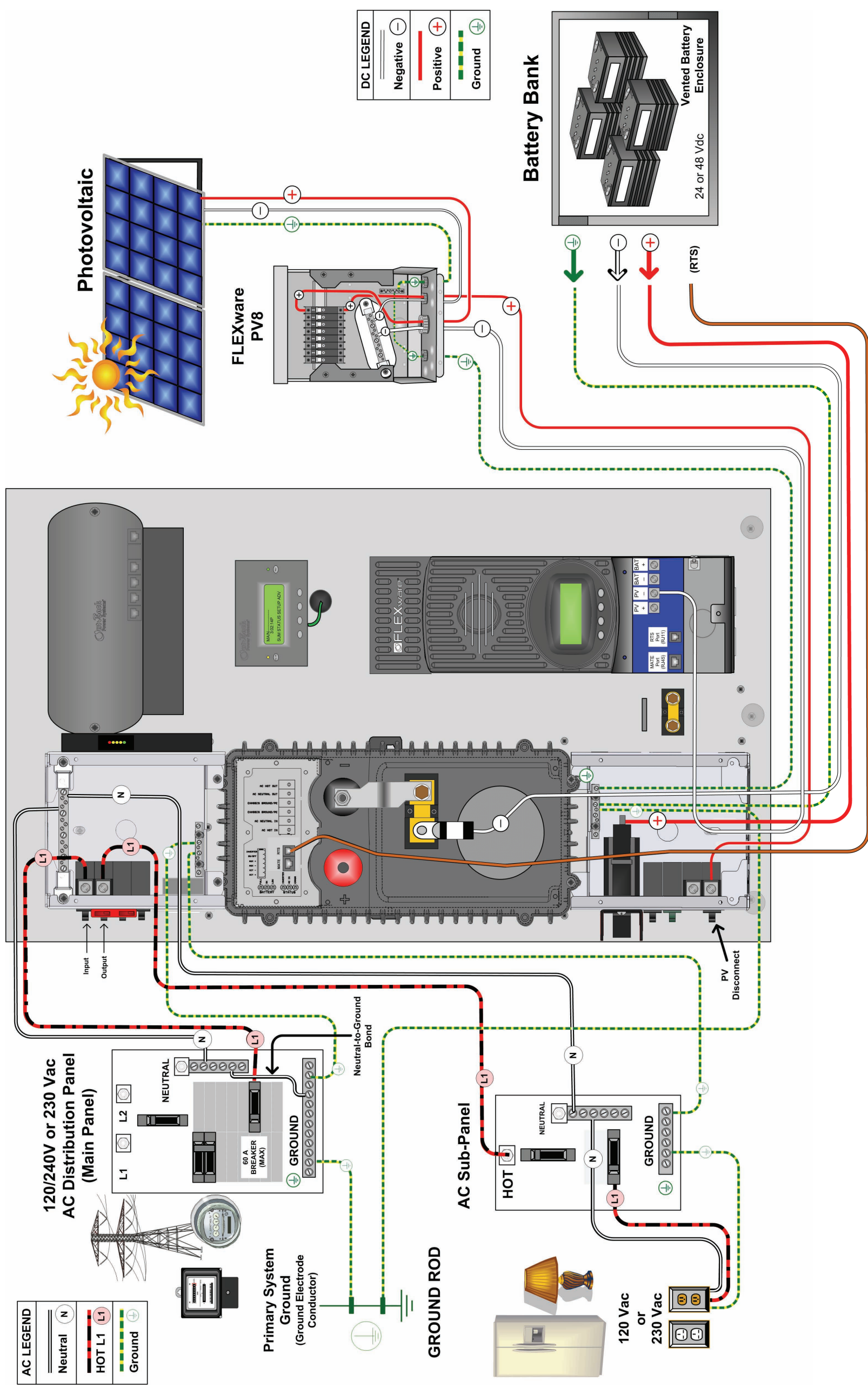

Figure 35 FLEXpower ONE with FLEXnet DC Monitor and GFDI

FLEXpower ONE with FLEXnet DC Monitor Only (no GFDI)

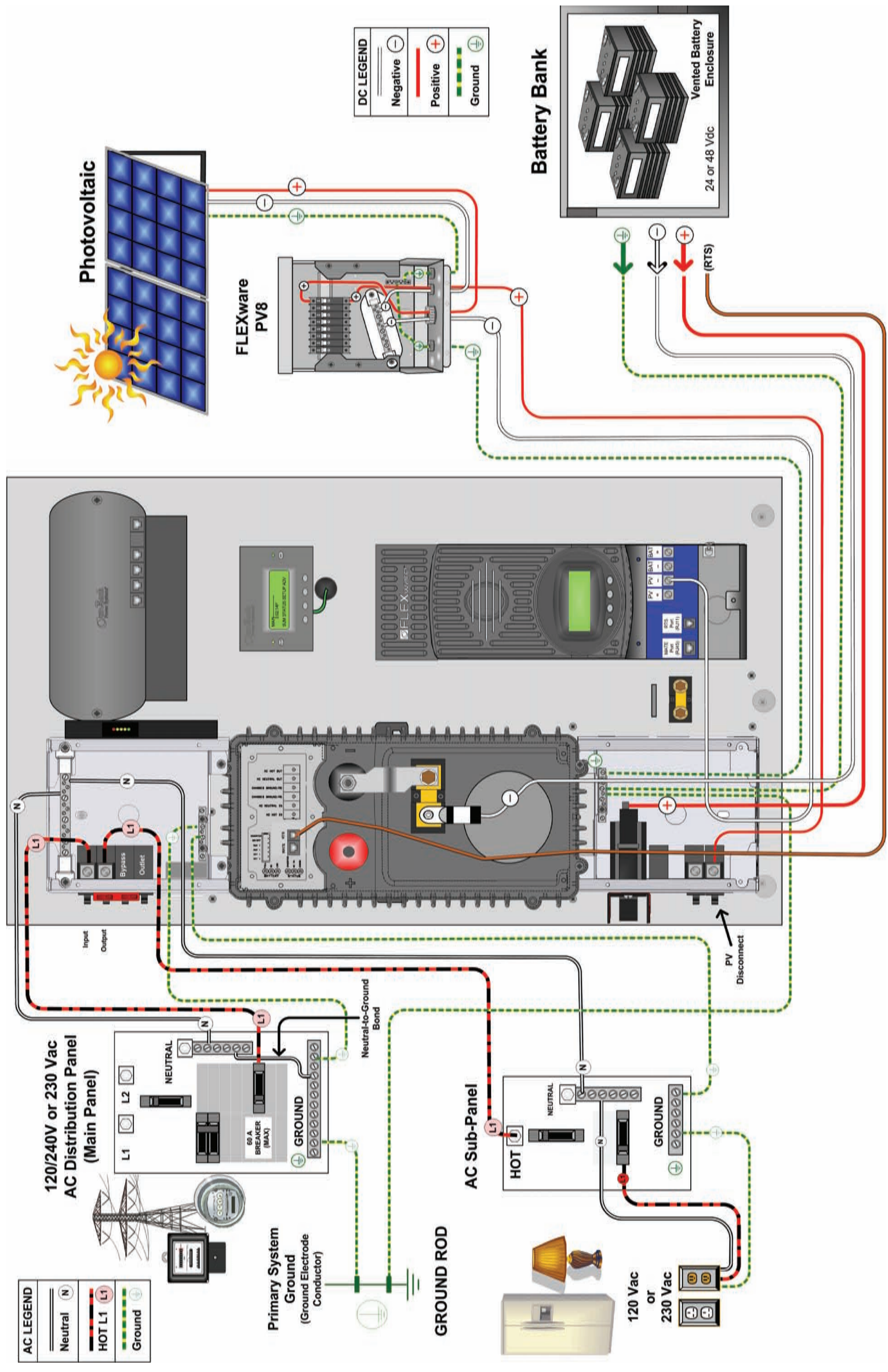

Figure 36 FLEXpower ONE with FLEXnet DC Monitor Only (No GFDI)

FLEXpower ONE with GFDI Only (no FLEXnet DC Monitor)

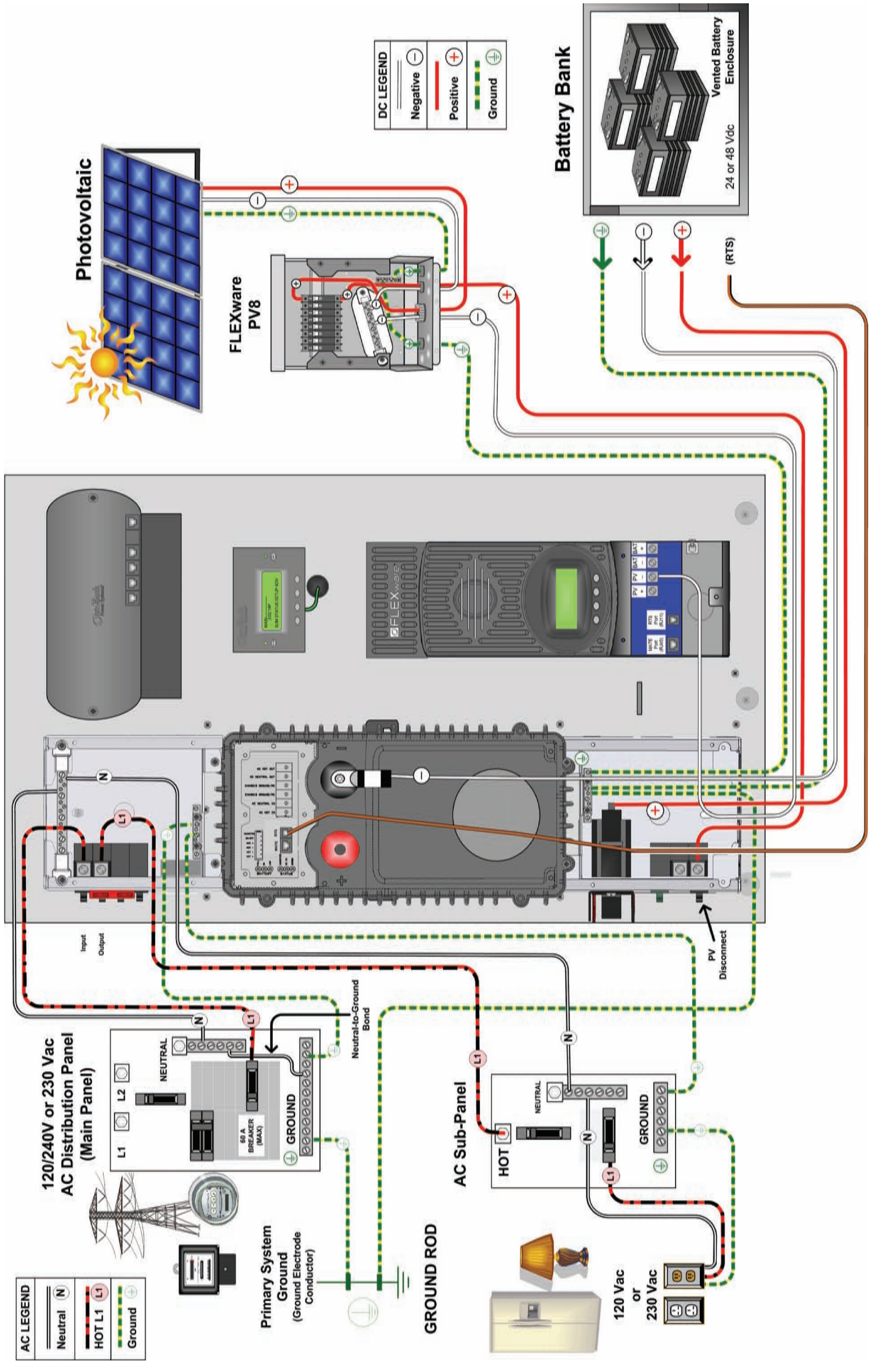

Figure 37 FLEXpower ONE with GFDI Only (no FLEXnet DC Monitor)

FLEXpower ONE (no FLEXnet DC Monitor or GFDI)

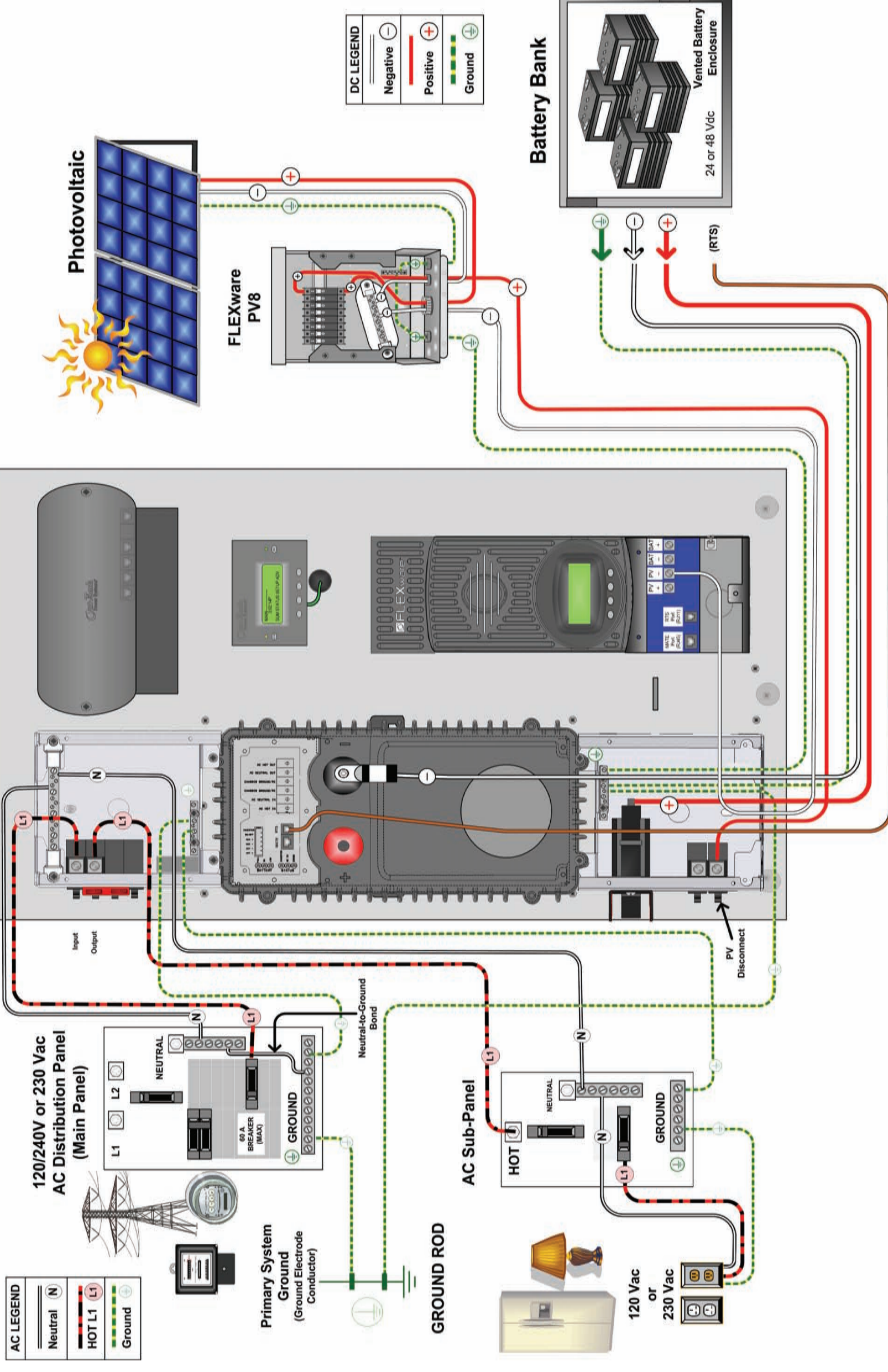

Figure 38 FLEXpower ONE (no FLEXnet DC Monitor or GFDI)



Warranty

5-Year Limited Warranty for FLEXpower ONE Products

OutBack Power Systems, Inc. (“OutBack”) provides a five-year (5) limited warranty (“Warranty”) against defects in materials and workmanship for its FLEXpower ONE products (“Product”) if installed in fixed location applications within the United States and Canada.

The term of this Warranty begins on the Product(s) date of manufacture or the initial purchase date as indicated on the warranty registration card submitted to OutBack, whichever is later. This Warranty applies to the original OutBack Product purchaser, and is transferable only if the Product remains installed in the original use location. The warranty does not apply to any Product or Product part that has been modified or damaged by the following:

- Installation or Removal;
- Alteration or Disassembly;
- Normal Wear and Tear;
- Accident or Abuse;
- Corrosion;
- Lightning;
- Repair or service provided by an unauthorized repair facility;
- Operation or installation contrary to manufacturer product instructions;
- Fire, Floods or Acts of God;
- Shipping or Transportation;
- Incidental or consequential damage caused by other components of the power system;
- Any product whose serial number has been altered, defaced or removed; or
- Any other event not foreseeable by OutBack.

OutBack’s liability for any defective Product, or any Product part, shall be limited to the repair or replacement of the Product, at OutBack’s discretion. OutBack does not warrant or guarantee workmanship performed by any person or firm installing its Products. This Warranty does not cover the costs of installation, removal, shipping (except as described below), or reinstallation of Products or parts of Products.

THIS LIMITED WARRANTY IS THE EXCLUSIVE WARRANTY APPLICABLE TO OUTBACK PRODUCTS. OUTBACK EXPRESSLY DISCLAIMS ANY OTHER EXPRESS OR IMPLIED WARRANTIES OF ITS PRODUCTS, INCLUDING BUT NOT LIMITED TO ANY IMPLIED WARRANTIES OF MERCHANTABILITY OR FITNESS FOR A PARTICULAR PURPOSE. OUTBACK ALSO EXPRESSLY LIMITS ITS LIABILITY IN THE EVENT OF A PRODUCT DEFECT TO REPAIR OR REPLACEMENT IN ACCORDANCE WITH THE TERMS OF THIS LIMITED WARRANTY AND EXCLUDES ALL LIABILITY FOR INCIDENTAL OR CONSEQUENTIAL DAMAGES, INCLUDING WITHOUT LIMITATION ANY LIABILITY FOR PRODUCTS NOT BEING AVAILABLE FOR USE OR LOST REVENUES OR PROFITS, EVEN IF IT IS MADE AWARE OF SUCH POTENTIAL DAMAGES. SOME STATES (OR JURISDICTIONS) MAY NOT ALLOW THE EXCLUSION OR LIMITATION OF WARRANTIES OR DAMAGES, SO THE ABOVE EXCLUSIONS OR LIMITATIONS MAY NOT APPLY TO YOU.

How to Arrange for Warranty Service

During the warranty period beginning on the invoice date, OutBack Power Systems will repair or replace products covered under this limited warranty that are returned to OutBack Power Systems' facility or to an OutBack Power Systems authorized repair facility, or that are repaired on site by an OutBack Power Systems authorized repair technician.



IMPORTANT:

For full Warranty description, see page 65.

Return Material Authorization (RMA)

To request warranty service, you must contact OutBack Technical Services at (360) 435-6030 or direct at (360) 618-4363 or support@outbackpower.com within the effective warranty period. If warranty service is required, OutBack will issue a Return Material Authorization (RMA) number.

A request for an RMA number requires all of the following information:

1. Proof-of-purchase in the form of a copy of the original Product purchase invoice or receipt confirming the Product model number and serial number;
2. OutBack issued warranty letter;
3. Description of the problem; and
4. Shipping address for the repaired or replacement equipment.

Returning Product to OutBack

After receiving the RMA number, pack the Product(s) authorized for return, along with a copy of the original purchase invoice and warranty certificate, *in the original Product shipping container(s) or packaging providing equivalent or reasonable protection*. Write the RMA number on the outside of the packaging where it is clearly visible.

Ship the products back to OutBack Power Systems in their original or equivalent packaging, prepay shipping charges, and insure the shipment or accept the risk of loss or damage during shipment.

OutBack Power Systems

RMA # _____
6115 192nd Street NE
Arlington, WA 98223 USA



IMPORTANT:

OutBack is not responsible for shipping damage caused by improperly packaged Products, the repairs this damage might require, or the costs of these repairs. If, upon receipt of the Product, OutBack determines the Product or Product part is defective and that the defect is covered under the terms of this Warranty, OutBack will then and only then ship a repaired or replacement Product or Product part to the purchaser freight prepaid, non-expedited, using a carrier of OutBack's choice, where applicable.

The warranty period of any repaired or replacement Product or Product part is ninety (90) days from the date of shipment from OutBack, or the remainder of the initial warranty term, whichever is greater.



Index

A

AC Conductor Size and Torque Requirements	33
AC Connections	34
Access Requirements	18
Accessing the Advanced Menus	46
Accessories	17
Advanced Menu	45
Applications	13
Audience	1

B

Batteries	
Amp-Hour Capacity	55
Amp-Hour Requirements	55
Amps to Watts	56
Bank Sizing	15, 55
Calculating Amp Hours	57
Days of Autonomy	55
Depth-of -Discharge	55
Discharge Rate	56
Estimating Amp Hours	56
Running Time and Size	55
Time and Power	56
Watts to Amps	56
Worksheet for Calculating Bank Size	59
Worksheet for Calculating Amp-Hour Reqmts. ...	58
Battery Bank	
Types of Batteries	15
Battery Bank Planning	15

C

Clearance	18
Commissioning	35
Components	12

D

DC Conductor Size and Torque Requirements	29
DC Connections without the FNDC	31
De-Energize	49
Default Settings	45
Definitions	2
Dimensions	19, 20

E

Energize	35
Environmental	17

F

Functional Test	35
-----------------------	----

G

Generator Requirements	16
Grid-Interactive Applications	14
Ground Conductor Size and Torque Requirements ...	28
Ground Connections	

I

Installation	23
--------------------	----

K

Knockout Preparation	21
----------------------------	----

L

Location	17
----------------	----

M

MATE Setup	42
Materials Required	17
Mounting	23

N

Neutral-to-Ground Bond	28, 34
------------------------------	--------

O

Off-Grid Applications	14
On-Grid Applications	13

P

Password	45
----------------	----

Planning	13
Preparation.....	17
Pre-startup Procedures.....	35
PV Connections.....	32
PV Planning.....	15
PV Sizing	55

R

Reassembling the Enclosures.....	38
Recycling Information.....	5
Earth 911	6
EPA	6
EuroRecycle.net.....	6
Keep America Beautiful	6
National Institute of Recycler's Mexico.....	6
Office of Waste Management, Canada.....	6
Regulatory	
References	5
Removing the Interior Cover	26

S

Safety	1
Battery	4
General	2
Personal.....	3
Photovoltaic	4
Sytstem.....	3
Setting Battery Amp-Hours.....	46
Setting the Date.....	42
Setting Time	42

Setup Screens	
MATE2	43
Shutdown	49
Shutdown Procedures	49
Specifications	
Environmental.....	52, 53
Feature Matrix.....	51
Mechanical	52, 53
Startup.....	35
Surge Protector	54
Symbols Used.....	1

T

Time and Date Display.....	42
Tools Required	17
Torque Requirements	
AC Conductors.....	33
DC Conductors	29
Ground Conductors.....	28

W

Warranty.....	2, 67
How to Arrange for Service.....	68
RMA.....	68
Terms and Conditions.....	67
Wiring	
DC Connections	29
<i>Grounding Connections</i>	28
Wiring Compartment	27

Thank you for supporting OutBack Power Systems by installing this product. Your patronage is greatly appreciated.

This product was proudly assembled in the United States of America and demonstrates the quality and pride of this great team of employees.

We sincerely hope your experience has been pleasant, positive, and professional and hope that you'll consider OutBack Power Systems for future purchases.

Sincerely,

The OutBack Power Systems Team
Arlington Washington

 **Soligent** YOUR OUTBACK POWER DISTRIBUTOR
SOLIGENT
800-967-6917
www.soligent.net



North America
19009 62nd Avenue NE
Arlington, WA USA
1.360.435.6030

European Office:
Barcelona, España
34.93.654.9568