

ABB solar inverters

# Product manual

## UNO-2.0-2.5-I-OUTD-(X)-US (2.0 to 2.5 kW)





## **IMPORTANT SAFETY INSTRUCTIONS**

*This manual contains important safety instructions that must be followed during installation and maintenance of the inverter.*



## **SAVE THESE INSTRUCTIONS!**

*Keep this document in a safe place near the inverter for easy access during installation and maintenance.*

## **THE INSTALLER MUST READ THIS DOCUMENT IN ITS ENTIRETY BEFORE INSTALLING OR COMMISSIONING THIS EQUIPMENT.**



*The purpose of this document is to support the qualified technician, who has received training and/or has demonstrated skills and knowledge in construction, to install and maintain this inverter. This manual does not cover any details concerning equipment connected to the inverter such as the solar modules. Information concerning the connected equipment is available from the respective manufacturers.*

*Warranty conditions can be found on the UNO product page of the website. NOTE: Any changes or modifications not approved by the responsible party could void the user authority to operate the equipment.*

## **FCC REMARKS**



*The equipment has been tested and found to comply with the limits for a Class B digital device, pursuant to Part 15 of the FCC Rules. These limits are designed to provide reasonable protection against harmful interference in a residential installation. This equipment generates, uses and can radiate radio frequency energy and, if not installed and used in accordance with the instructions, may cause harmful interference to radio communications.*

*However, there is no guarantee that interference will not occur in a particular installation. If this equipment does cause harmful interference to radio or television reception, which can be determined by turning the equipment off and on, the user is encouraged to try to correct the interference by one or more of the following measures:*

- *Reorient or relocate the receiving antenna.*
- *Increase the separation between the equipment and receiver.*
- *Connect the equipment into an outlet on a circuit different from that to which the receiver is connected.*
- *Consult the dealer or an experienced radio/TV technician for help.*

---

## Product Manual

### UNO-2.0-2.5 string inverters

1 - Introduction and safety



2 - Installation location



3 - Mounting and wiring



4 - Operations



5 - Troubleshooting



6 - Maintenance



7 - Appendix



# Contents

<b>Introduction and safety</b> .....	<b>7</b>
Warnings in this document .....	7
Equipment safety warnings .....	7
General installation warnings .....	8
Assembly warnings .....	8
Electrical connection warnings .....	8
Safety instructions .....	9
General information .....	9
Thermal and voltage hazards .....	9
Clothing and protective devices .....	9
Location of safety notices and labels .....	10
Appropriate usage .....	10
Conditions of use .....	10
Environmental conditions .....	10
Improper or prohibited use .....	10
Available models .....	11
Product label .....	11
Regulatory nameplate .....	12
<b>Installation location</b> .....	<b>13</b>
Transportation and handling .....	13
Incoming inspection .....	13
Select the installation location .....	15
Environmental check .....	15
Installation position .....	16
<b>Mounting and wiring</b> .....	<b>19</b>
Labeled illustration of UNO inverter .....	19
Wall or pole mounting .....	21
Wiring preparations .....	23
Check the polarity of the strings .....	23
Checking leakage to ground of the PV array .....	24
Open the inverter cover .....	24
Electrical system components .....	25
System grounding .....	26
Protective earth connection (PE) .....	26
Earth (ground) connection .....	26
Grounding configuration of DC inputs .....	27
Additional grounding connection in switchbox (-S version) .....	28
Connection to PV field (DC side) .....	28
DC inputs - standard version (no switchbox) .....	29
DC inputs - S version (switchbox) .....	30
Grid output connection (AC side) .....	31
Grid standard/country setting .....	32
Communication and signal wiring connections .....	33
Serial communication connection (RS-485) .....	34
Daisy chain units for connection to a monitoring system .....	36
Addressing each inverter .....	37

Monitoring system via serial (RS-485).....	37
Monitoring system via RADIOMODULE .....	37
Configurable relay connection (Alarm) .....	39
Remote control connection .....	39
<b>Operations.....</b>	<b>41</b>
Monitoring and data transmission .....	41
Types of data available .....	41
User interface.....	41
Display and keypad .....	42
LED indicators.....	43
Descriptions of symbols and display fields .....	44
Cyclical display of general information.....	45
Statistics menu .....	46
Settings menu .....	47
Information Menu.....	53
Commissioning.....	54
Power ON the inverter .....	54
Dynamic behavior of the display during operation .....	55
Power graph .....	55
<b>Troubleshooting.....</b>	<b>57</b>
Obtaining the service level password.....	57
Display messages and error codes .....	57
Verification of ground leakage .....	69
Behavior of a system without leakage .....	69
Behavior of a system with leakage.....	70
Measuring the insulation resistance (RISO).....	71
Making a service call.....	72
<b>Maintenance.....</b>	<b>73</b>
Power-down procedure .....	73
Routine maintenance .....	74
Other maintenance .....	74
Storage and dismantling .....	75
<b>Appendix.....</b>	<b>77</b>
System description .....	77
Protective devices within the inverter.....	78
Topographic diagram of the equipment .....	78
Efficiency curves .....	80
Automatic power reduction.....	82
Technical data and types .....	84

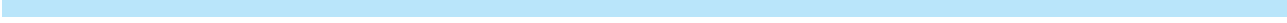

## Introduction and safety

# 1

### Warnings in this document

This is a list of special safety symbols used in this manual that highlight potential safety risks and/or useful information. The symbol usage is described below:

**CAUTION**

The reader should stop, use caution and fully understand the operations explained before proceeding.

**DANGEROUS VOLTAGE**

The product works with high voltages. All work on the UNO inverter must follow the described documentation and must comply with all prevailing codes and regulations associated with high voltages.

**HOT TEMPERATURE**

Some surfaces may become hot; do not touch the product while it is in operation.



UL1741 Standard for Safety for Inverters, Converters, Controllers and Interconnection System Equipment for use with Distributed Energy Resources. CSA-C22.2 No. 107.1-01 - General Use Power Supplies.

### Equipment safety warnings

In addition to the safety and hazard symbols, the following symbols are also used in this installation guide



System earth conductor (equipment ground, protective earth)



Alternating current (AC)



Phase



Direct current (DC)



Grounding (earth)

## General installation warnings

The UNO isolated inverter is designed and tested according to international safety requirements (UL1741/IEEE1547); however, certain safety precautions must be observed when installing and operating this inverter.

All operations regarding transport, installation start up, and maintenance, must be carried out by qualified, trained personnel and in compliance with all prevailing local codes and regulations.

## Assembly warnings

Prior to installation, inspect the unit to ensure absence of any transport or handling damage, which could affect insulation integrity or safety clearances; the failure to do so could result in safety hazards.

Assemble the inverter per the instructions in this manual. Use care when choosing the installation location and adhere to specified cooling requirements. Unauthorized removal of necessary protection features, improper use, incorrect installation or operation may lead to serious safety and shock hazards and/or equipment damage.

## Electrical connection warnings

This grid-tied inverter system operates only when properly connected to the AC utility grid. Before connecting the UNO grid-tied inverter to the AC utility grid, contact the local power distribution company to receive the appropriate approvals. This connection must be made only by qualified technical personnel.



Wiring methods used should be in accordance with the National Electric Code (NEC), ANSI/NFPA 70 and/or any prevailing local codes and regulations.

All photovoltaic source and output circuit conductors **MUST** have disconnects complying with the NEC, Section 690, Part III. The -S models include an integrated DC disconnect switch.



Output circuits must be isolated from the enclosure. System grounding, required by Sections 690.41 - 690.43 of the Nec, ANSI/NFPA 70, is the responsibility of the installer.

Connect only to a dedicated branch circuit provided with the maximum branch Over Current Protection Device (OCPD) in accordance with the CSA document available online and listed on the technical data sheet found in the appendix, section 7.



## Safety instructions

These servicing instructions are for use by qualified personnel only. To reduce the risk of electric shock, do not perform any servicing other than that specified in the operating instructions.

Be sure all flammable materials including construction items are away from the unit. Do not install the inverter in or near potentially explosive areas.

The installer and/or operator must properly protect the installation from access by the public and/or highlight with signs or notices the potential hazards of the equipment, e.g., magnetic fields, hazardous voltages, high temperatures, possibility of discharges, generic hazard, etc..



## General information

The equipment has been manufactured in accordance with the strictest accident-prevention regulations and supplied with safety devices suitable for the protection of components and operators. Inform ABB about non-standard installation conditions.

The instructions given in the manual do not replace the information and warnings on the safety labels mounted on the product. They do not replace the safety regulations enforced in the country of installation.

Do not use the equipment if any operating anomalies are found. All repairs should be carried out using only qualified spare parts, which must be installed in accordance with their intended use and by a licensed contractor. Liabilities arising from commercial components are delegated to their respective manufacturers.

## Thermal and voltage hazards



**HOT TEMPERATURES!** Depending upon ambient temperatures during operation and immediately following shut down, surface temperatures on the cooling fins (heat sink) and some areas of the chassis may be extremely hot to the touch.

Prior to touching any part of the inverter use care to ensure surfaces and equipment are at touch-safe temperatures and voltages before proceeding.

Anytime the inverter has been disconnected from the AC utility grid, use extreme caution as some components can retain charge sufficient to create a shock hazard and may need at least five minutes to dissipate the charge. To minimize occurrence of such conditions, comply with all corresponding safety symbols and markings present on the unit and in this manual.

## Clothing and protective devices

Appropriate Personal Protective Equipment (PPE) must be worn at all times when servicing this equipment under any conditions which may subject personnel to hazardous voltages or temperatures that are not touch-safe. All operations on the equipment should be performed with properly electrically insulated instruments.

## Location of safety notices and labels

Note the location of safety notices on the inverter for notification and protection. Labels must not be hidden with external objects or parts such as rags, boxes, or other such equipment. They should be cleaned periodically and always maintained in view.



## Appropriate usage

The UNO Inverter is a photovoltaic inverter that converts direct current of a connected PV array into alternating current and feeds that power into the AC utility grid.

This inverter is designed for outdoor use, but can be used indoors if installed to specified environmental and mounting parameters stated in this manual, and adherence to the National Electric Code. See environmental conditions below and environmental check in section 2.

## Conditions of use

The DC and AC operating currents **MUST NOT** exceed the limits documented in the technical specifications found in the data table in the appendix, section 7.

The inverter is certified for use only with photovoltaic arrays connected to its input channel(s). Do not connect batteries or other types of power sources.

## Environmental conditions

Adverse environmental conditions can lead to a reduction in performance. The equipment should be installed outdoors, but only in environmental conditions indicated in this manual. Care must be taken to provide adequate ventilation if installed indoors.

## Improper or prohibited use

The following actions are dangerous and not consistent with acceptable practice under the terms of the warranty:

- Installing the equipment in environments with flammable conditions.
- Using the equipment with safety devices not working or disabled.
- Using the equipment or parts of the equipment by connecting it to other machines or equipment, unless otherwise expressed.
- Modifying areas that are operator restricted and/or altering parts of the equipment in order to vary the performance or change its protection.
- Cleaning with corrosive products that may corrode parts of the equipment or with products that might generate electrostatic charges.
- Using or installing the equipment or parts of it without having read and correctly interpreted the contents of this manual.
- Blocking airflow to the cooling fins (e.g., warming or drying rags) on the unit or accessory parts is dangerous and could compromise the inverter operation.

## Available models

The inverters are divided into two models according to their rated output power of 2.0kW or 2.5kW.

2.0 kW	UNO-2.0-I-OUTD-US UNO-2.0-I-OUTD-S-US	<b>Unit Weight -S version:</b> 42.5lb/ 19.3kg <b>No switchbox version:</b> 37.4lb/ 17kg <b>Dimensions (H x W x D) -S version:</b> 30.3 x 14.4 x6.3 in/ 769 x 367 x 161mm) <b>No switchbox version:</b> 20.4 x 14.4 x 6.3 in/ 518 x 367 x 161mm
2.5 kW	UNO-2.5-I-OUTD-US UNO-2.5-I-OUTD-S-US	



For inverters of equal output power the difference between the models is the presence or lack of the switchbox and integrated DC disconnect switch.

UNO-2.0/2.5-I-OUTD-US: No switchbox

UNO-2.0/2.5-I-OUTD-S-US: Wiring box with integrated DC Disconnect Switch

## Product label

The product label shown below is affixed to the inverter and provides the following information:

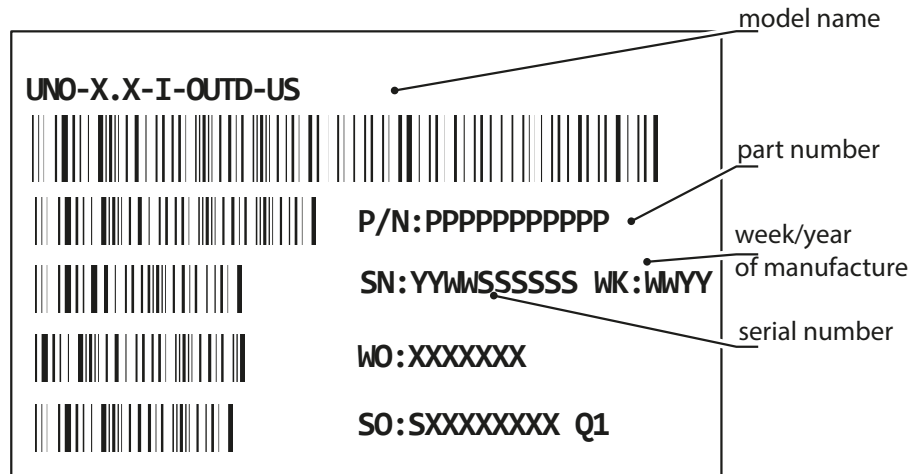

## Regulatory nameplate

Technical data in this manual does not supersede the data on the labels affixed to the equipment. The product nameplate is affixed to the inverter chassis and provides the following information:

- 1) Certification
- 2) Product origin
- 3) Model type and number
- 4) DC input ratings
- 5) AC output ratings

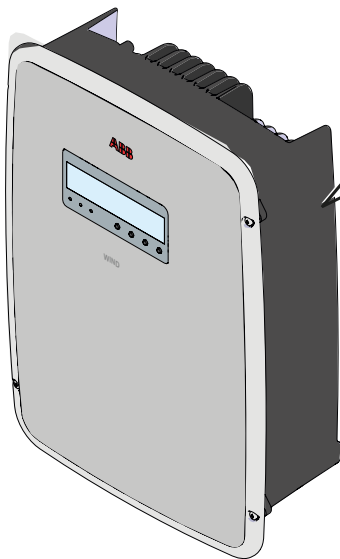

**ABB**

www.abb.com/solar

SOLAR UTILITY INTERACTIVE INVERTER

MODEL: UNO-2.5-I-OUTD-S-US

1



UL 1741  
CSA-C22.2 No. 107.1-01

2

Country of Origin Italy

### DC RATING 4

Nominal Input Operating Voltage	340 V $\text{---}$
Max. Input Voltage	520 V $\text{---}$
Range of Input Operating Voltage	90 - 520 V $\text{---}$
Range of Input Voltage @Full Power	200 - 470 V $\text{---}$
Max. Input Current	12.8 A
Max. Input Short Circuit Current (P.V. Panels)	16 A

### AC RATING 5

Nominal Output Voltage	277 V $\sim$ / 240 V $\sim$ / 208 V $\sim$ 1 $\emptyset$
Operating Voltage Range	244-304 V $\sim$ /211-264 V $\sim$ /183-228 V $\sim$
Nominal Output Frequency	60 Hz (factory preset)
Operating Frequency Range	59.3 (1) - 60.5 (2) Hz
Output Power Factor	>0.995
Max. Output Current (for each phase)	10.5 A / 12 A / 12 A (rms)
Max. Continuous Output Power	2500 W @ 45°C amb.
Max. Output Overcurrent Protection	15 A

Operating Ambient Temperature: -25 to +60 °C (-13 to +140 °F), with Output Power Derating  
Type of Enclosure: NEMA 4X  
DC Ground Fault Detector/Interrupter is Provided

(1): Adjustable from 57.0 Hz to 59.7 H (2): Adjustable from 60.5 Hz to 63.0 Hz  
For more details about product specifications refer to the Instruction Manual

This device complies with Part 15 of the FCC Rules. Operation is subject to the following two conditions: (1) this device may not cause harmful interference, and (2) this device must accept any interference received, including interference that may cause undesired operation.

## Installation location

2

## Transportation and handling

When being transported, the inverter and electronic components must be protected from vibration, mechanical shocks, humidity, etc.



## Incoming inspection

It is the customer's responsibility to examine the condition of the unit. Upon receipt of the inverter check the following:

- Inspect the shipping container for any external damage.
- Inventory the contents against the table below and verify receipt of all items.
- Use care not to discard any equipment, parts, or manuals.
- Call the delivering carrier if damage or shortage is detected.

If inspection reveals damage to the inverter, contact the supplier or authorized distributor for a repair/return determination and instructions regarding the process. The equipment components supplied are inserted into a cardboard box placed within the packaging of the UNO.

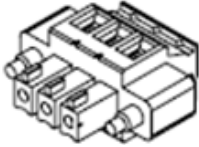
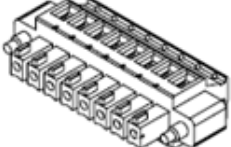
QTY	Description of carton contents
1	UNO Inverter
1	Quick Installation Guide
1	Equipment components (next page)

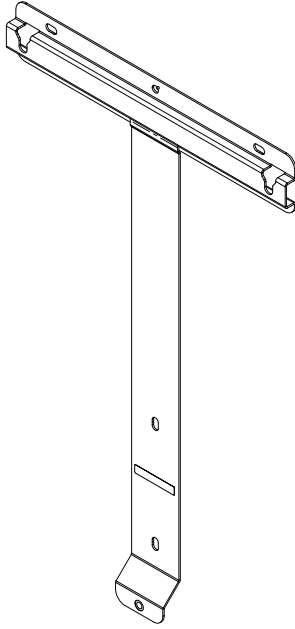
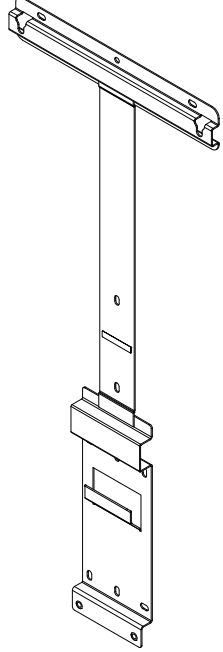
Components for all models	Description	QTY/part#
	3 pin connector for configurable relay	2 82000005907-G
	8 pin connector for communication signals	2 82000005908-G
	L-key tool; TORX WRENCH; 90°	1 81510000077
	<p>1 Wall bracket for mounting</p> <p>5 each anchors and screws 3x70mm; DIN 7981 A2 and</p> <p>2 each locking screw for fastening inverter to bracket pan head; M6x16; stainless steel; A2</p>	Mounting kit for standard version (no switchbox) XAK.V0E02.0
	<p>1 Wall bracket for mounting</p> <p>5 each anchors and screws 3x70mm; DIN 7981 A2</p> <p>2 each locking screw for fastening inverter to bracket pan head; M6x16; stainless steel; A2</p>	Mounting kit for -S version (switchbox) XAK.V0E10.0

## Select the installation location



**WARNING!** The inverter must be installed by qualified installers and/or licensed electricians according to the applicable local code regulations (NEC, CEC, and other).

Once physically mounted, the wiring must be carried out with the equipment disconnected from the grid (power disconnect switch open) and the photovoltaic panels shaded or isolated.

## Environmental check



- See technical data in the appendix, section 7, to check the environmental parameters to be observed (degree of protection, temperature, humidity, altitude, etc.).
- The maximum operational ambient air temperature **MUST** be considered when choosing the inverter installation location.
- Installing the inverter where operating temperatures exceed the specifications will result in power limiting.
- Exposure to direct sunlight will increase the operational temperature of the inverter and may cause output power limiting.
- The use of a sun shade minimizing direct sunlight is recommended when the ambient air temperature around the unit exceeds 104°F/40°C.
- Do not install in small closed spaces where air cannot circulate freely.
- Due to acoustical noise (about 50dBA at 1 m) from the inverter, do not install in rooms where people live or where the prolonged presence of people or animals is expected.
- To avoid overheating, always make sure the flow of air around the inverter is not blocked.
- Do not install in places where gases or flammable substances may be present.

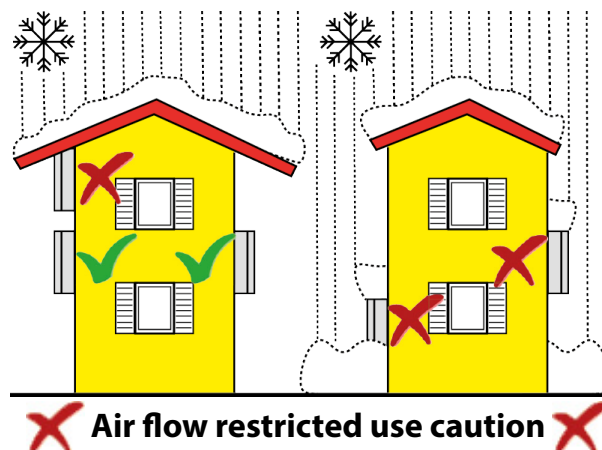
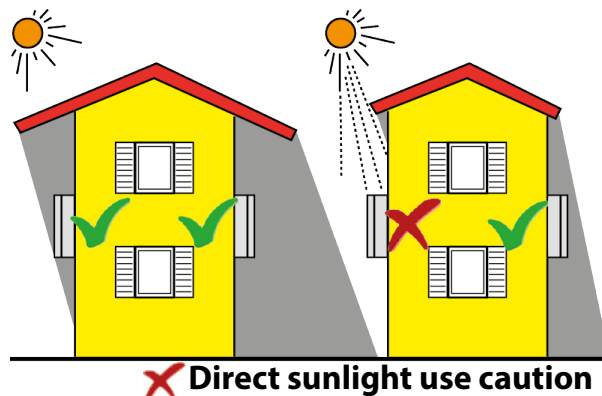

## Installation position

When planning the installation, maintain clearance distances illustrated below to allow normal control functions and easy maintenance operations. When choosing the location and position, comply with the following conditions:

- Install on a wall or strong structure capable of bearing the weight.
- Install vertically with a maximum incline of +/- 5°.
- If the mounted inverter is tilted to an angle greater than the maximum noted, heat dissipation can be inhibited, and may result in less than expected output power.
- Maintain minimum clearances from walls, roofs, ceilings, and other structures.
- To avoid overheating, always make sure the flow of air around the inverter is not blocked by walls, roofs, ceilings, and other objects, including other inverters.
- Install in safe place where all switch handles and controls remain easy to reach and meet height requirements of the applicable electrical code.
- If possible, install at eye level so the display and status LEDs can be easily seen.
- Ensure sufficient working area in front of the inverter to allow removal of the wiring box cover and easy access for servicing the inverter.
- Position multiple inverters side-by-side, maintaining minimum clearances.
- Multiple inverters can also be placed in a staggered arrangement.

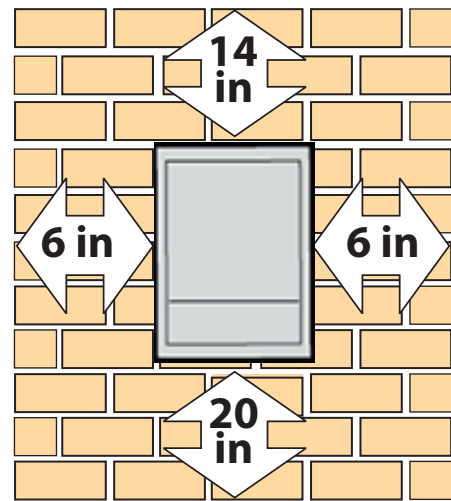
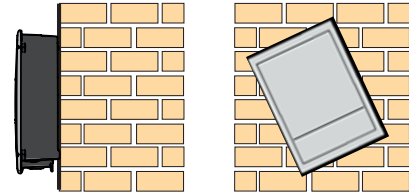
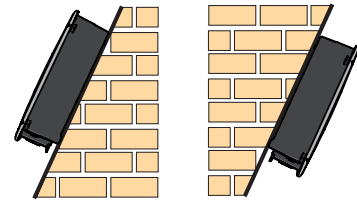

Minimum clearances illustrated for staggered arrangement includes width of inverter plus additional allowances for inverters arranged above or below.

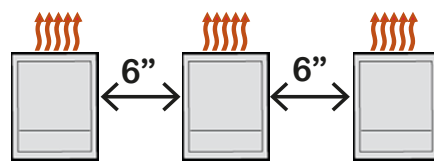

Side-by-side arrangement

This minimizes heat dissipation from lower inverters affecting operation of other inverters.

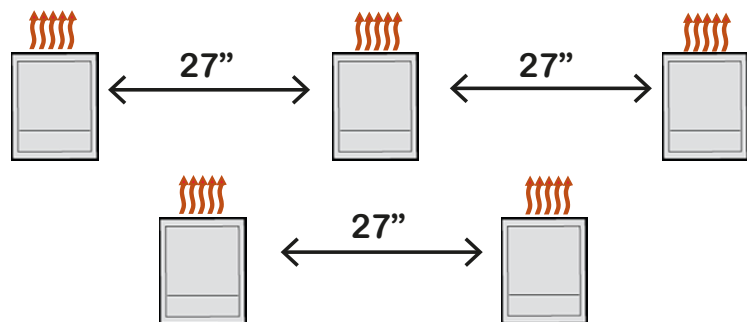

Staggered arrangement



Overall dimensions of the inverter are expressed in millimeters and inches.

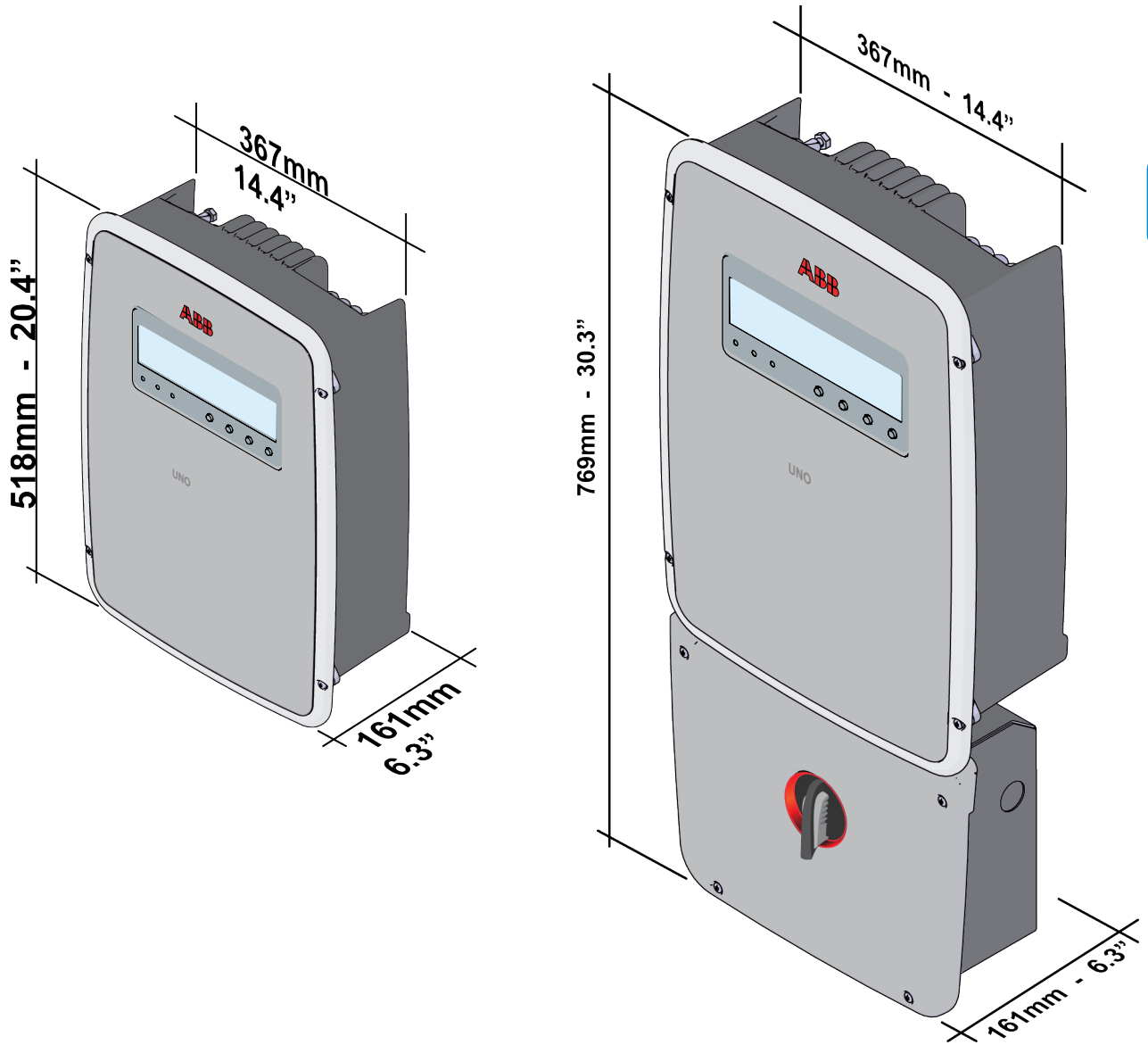



## Mounting and wiring

# 3

### Labeled illustration of UNO inverter

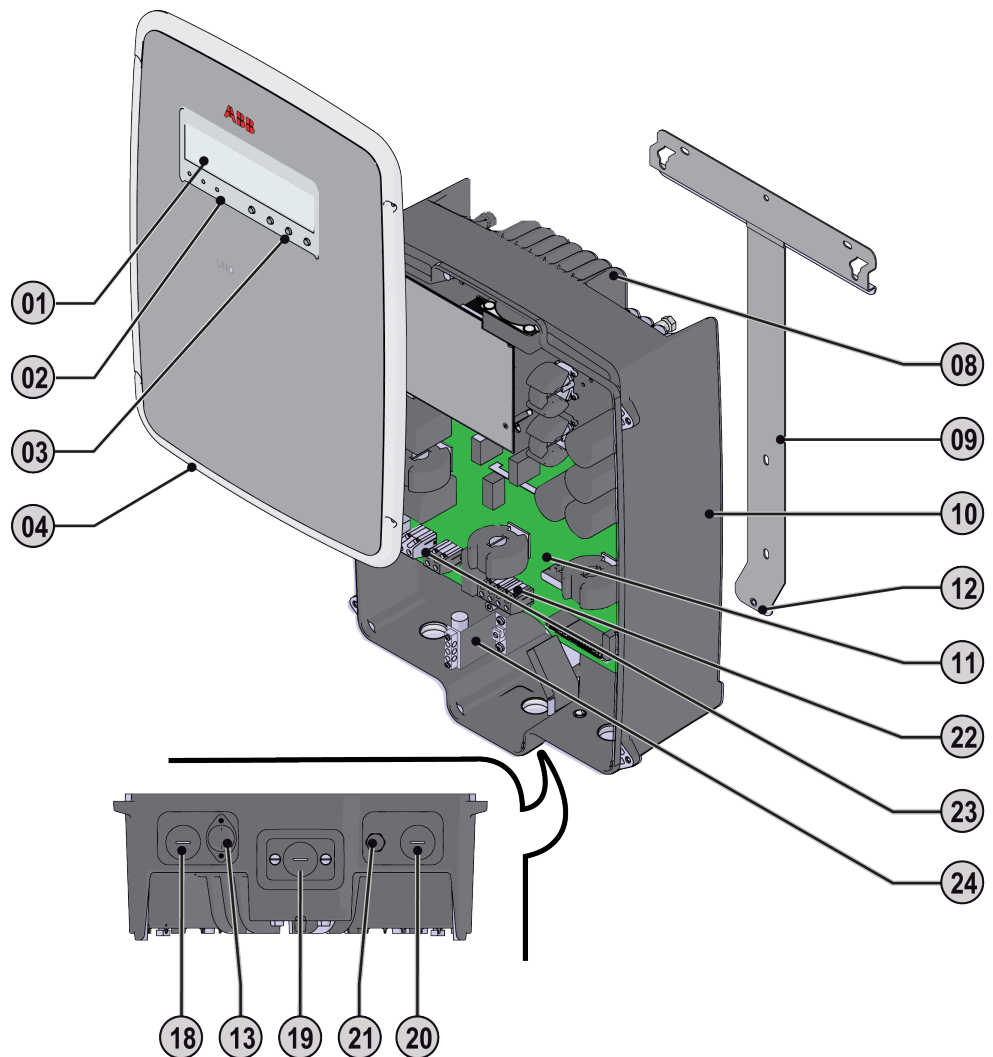

#### Standard version (no switchbox) description of components

01	display	10	inverter chassis	20	signal conduit entry**
02	LED panel	11	main board.	21	anti-condensation valve* DO NOT REMOVE!
03	keypad	12	locking tabs	22	AC output screw terminal block
04	inverter cover	13	fuse holder	23	DC input screw terminal block
08	heat sink	18	DC conduit entry	24	ground terminals
09	mounting bracket	19	AC conduit entry	* eliminates condensation buildup	

**-S version (switchbox) description of components**

01	display	08	heat sink	14	DC input terminal block
02	LED panel	09	mounting bracket	16	AC output terminal block
03	keypad	10	inverter chassis	17	electric duct
04	inverter cover	11	main board.	18	DC conduit entry
06	switchbox cover	12	locking tabs	19	AC conduit entry
07	DC disconnect switch	13	fuse holder	20	signal conduit entry

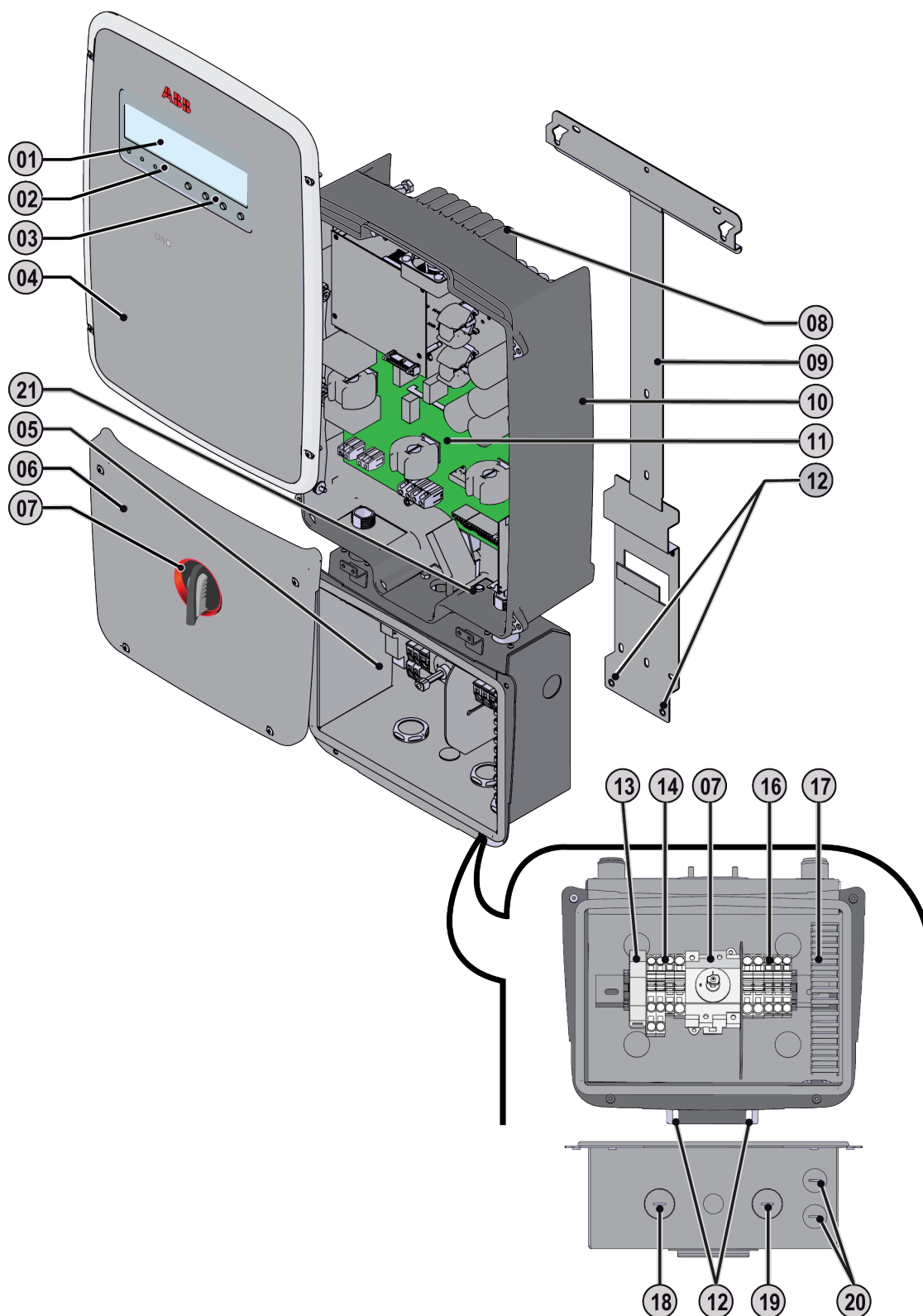

## Wall or pole mounting

### Standard version no switchbox

Note the location of the necessary mounting holes based on the mounting surface:

- Group A holes are used for pole mount.
- Group B holes are used for wall mount.
- Position the bracket in the desired mounting position, ensuring it is level, and mark the holes appropriate to the type of mounting surface.
- Drill the holes required with 10mm/0.39" bit. The holes must be about 70mm/2.75" deep.
- Fix the bracket to the wall/pole with the wall anchors, (supplied) 10mm/0.39" in diameter.
- Hook the inverter to the bracket by inserting the head of the inverter rear screws in the slots as shown.
- Anchor the inverter to the bracket by tightening the locking screw in the tab located on the bottom.

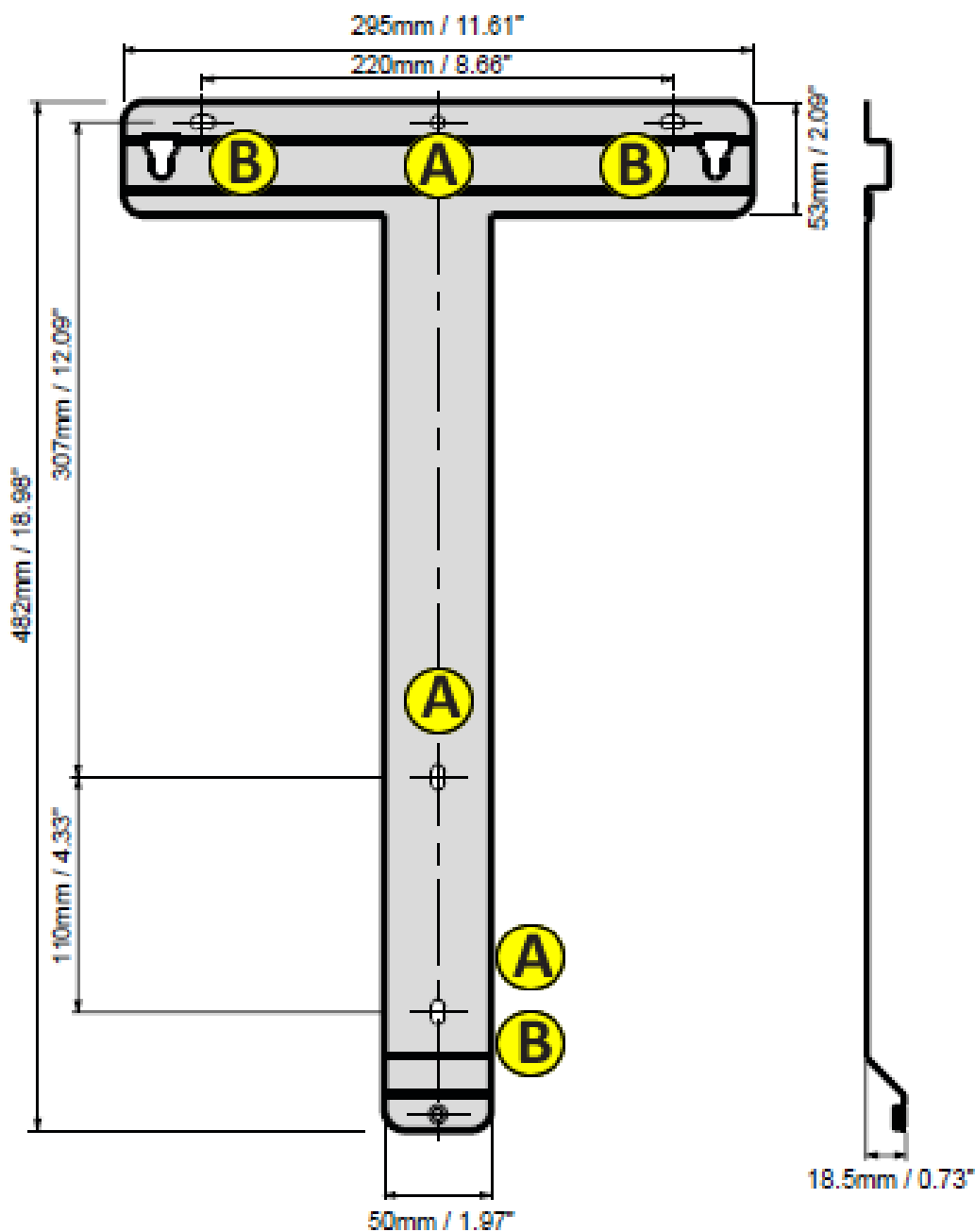

**-S version with switchbox**

Note the location of the necessary mounting holes based on the mounting surface:

- Group A holes are used for pole mount (Figure 3 6)
- Group B holes are used for wall mount
- Position the bracket in the desired mounting position, ensuring it is level, and mark the holes appropriate to the type of mounting surface.
- Drill the holes required using a 10mm/0.39" bit. The holes must be about 70mm/2.75" deep.
- Fix the bracket to the poll/wall with the wall anchors, 10mm/0.39" in diameter, supplied.
- Hook the inverter to the bracket by inserting the head of the inverter rear screws and the anchor point on the wiring box, in the slots of bracket
- Anchor the inverter to the bracket by tightening the locking screw in the tab located on the bottom.

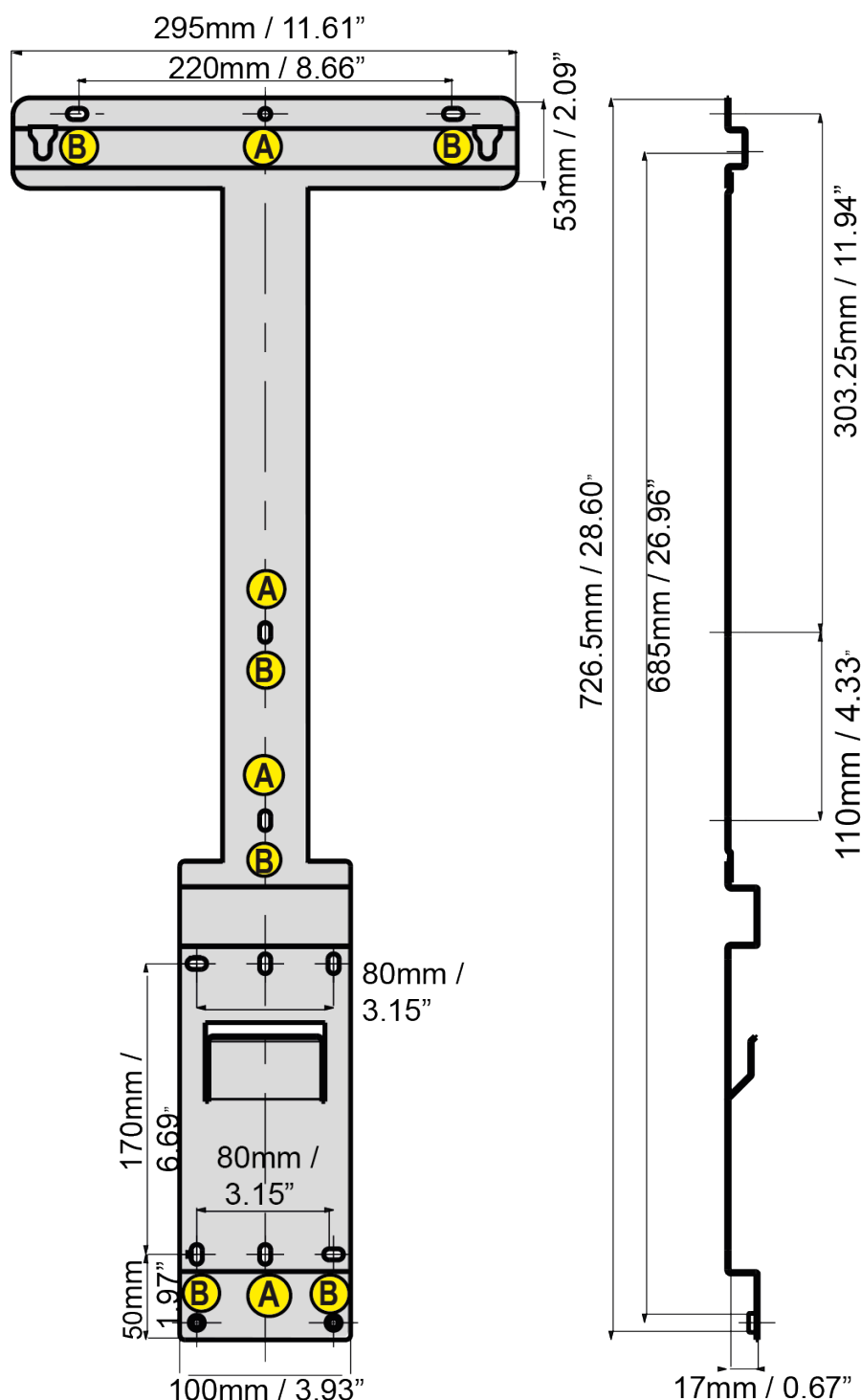

## Wiring preparations

Always respect the nominal ratings of voltage, current, and power defined in the appendix, part 7, when designing your system. Observe the following considerations:



**WARNING!** To reduce the risk of fire, connect only to a circuit provided with 15A maximum branch circuit overcurrent protection in accordance with NEC (ANSI/NFPA 70). See Maximum AC OCPD requirement in technical data table, part 7.

An automatic overcurrent device (e.g. circuit breaker) must be installed between the UNO inverter and the AC utility grid. It is the responsibility of the end user to provide protection for the AC output circuit.

All photovoltaic source and output circuit conductors shall have disconnects complying with the NEC, Section 690, Part III. A DC switch should be inserted when not integrated in the inverter. The -S models have an integrated DC switch.



The -S version of the UNO utilizes pressure type terminal blocks for connection of all conductors. Acceptable wire size range is from 12 AWG to 6 AWG; refer to local codes for appropriate wire size. Use only copper wire rated at least 90° C. Use the following procedure to connect wiring to these blocks.

- Strip  $\frac{1}{2}$ " of insulation from the end of the conductor to be terminated and twist strands.
- Use a small (~1/4" wide) flat blade screwdriver to open the pressure contact.
- Insert the screwdriver in the rectangular tool slot at an angle.
- Lightly press the screwdriver toward the associated wire slot until the clamp opens; hold the clamp open with the screwdriver.
- Insert the wire into the associated round wire slot until seated.
- Release the pressure on the screwdriver and remove it from the slot.
- Check security of the wire in the connector by gently tugging the wire.

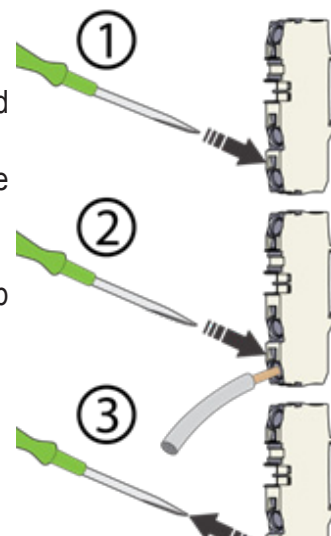

## Check the polarity of the strings



Verify that the DC voltage in the wiring box has the correct polarity and is within the operational range.

Note the ambient temperature and, using a voltmeter, check the voltage of each string and confirm the following:

- Confirm the measured voltage falls within the input voltage specification limit of the inverter (see technical data in the appendix, part 7).
- If the open circuit voltage of any string is close to the maximum accepted inverter voltage, check array design to ensure that voltage will not be outside max allowable range under low-temperature conditions.

## Checking leakage to ground of the PV array

This test must be done with the string/array in an open circuit condition – both leads floating. Prior to connecting the array wiring to the inverter, measure the voltage present between positive and negative pole of each string with respect to ground. If a voltage is measured between an input pole and ground, it may be that there is a low insulation resistance of the photovoltaic array and the installer will have to carry out a check to solve the problem.



**WARNING!** Do not connect the strings if a leakage to ground has been found because this is an unsafe condition. Make sure any leakage condition found is resolved before connecting array to the inverter.

## Open the inverter cover

The inverter cover and switchbox cover **05** must be removed to access the electrical wiring and connections.

**The inverter cover is equipped with fixed hinges and is not intended to be removed from the chassis.**

The wiring box cover **06** must be removed before opening the inverter cover **04**.

Loosen the four captive screws and remove the wiring box front cover **06**.

Loosen the four captive screws on the inverter front cover **04**.

Using light pressure pull out and up on the cover so it rotates in an upward arc to its rest position.

Remove the protective film located on the display **01** of inverter front cover **04**.

When connection operations are complete, close covers and tighten the captive screws with at least 2.0Nm (17.7 in-lbs) torque to maintain waterproof sealing.

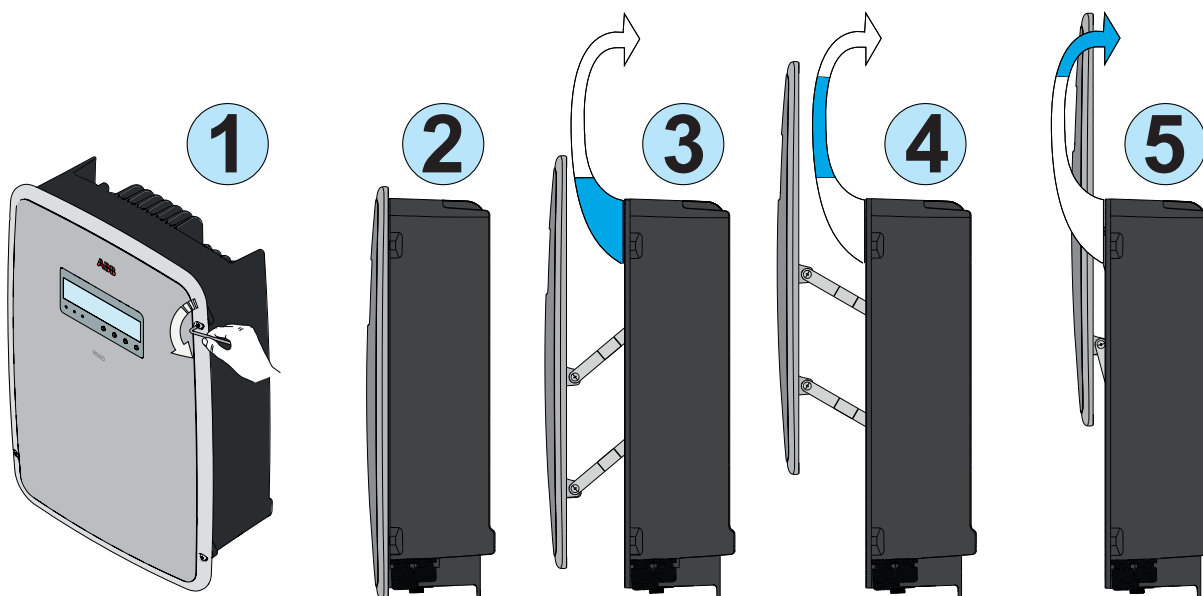



## Electrical system components

Label	Description	Label	Description
07	DC disconnect switch	21	Condensation Relief Valve
11	Main board	22	AC output screw terminal block, note 1
13	Ground fault fuse	23	DC input screw terminal block, note 1
14	DC input terminal blocks	24	Earth (ground) terminal
16	AC output terminal blocks	25	Earth (ground) terminal
17	Signal wiring duct	26	Protective earth terminal
18	DC knockout plug	a02	Ground cable
19	AC knockout plug	a03	Connector for negative grounding of the inputs
20	Signal wiring knockout plug	a04	Connector for positive grounding of the inputs

Note 1: tighten with at least 1.5Nm (13.5 in-lbs) torque to maintain NEMA4X protection

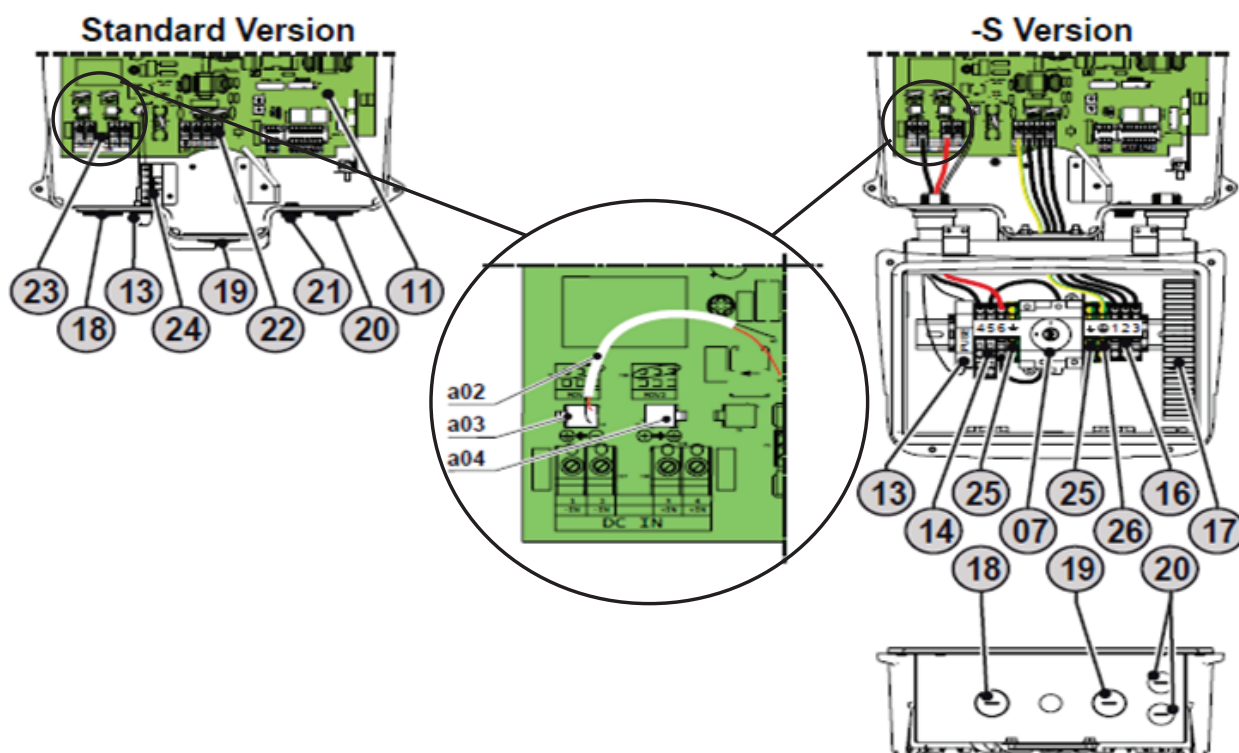

## System grounding



**WARNING!** To prevent electrical hazards, all the connections must be carried out with the disconnect switch downstream of the inverter (grid side) open and locked

### Protective earth connection (PE)



**NOTE!** Both NO switchbox and -S versions of the inverter include a protective earth terminal **22/26** for the external protective conductor identified by the symbol specified at left on the terminal.

PE connection standard version

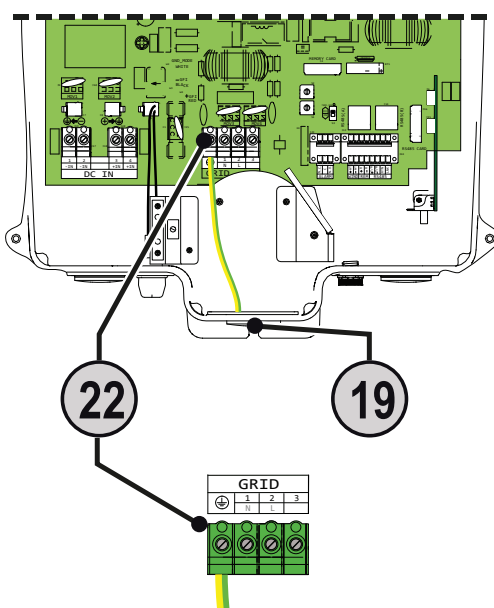

PE connection -S version

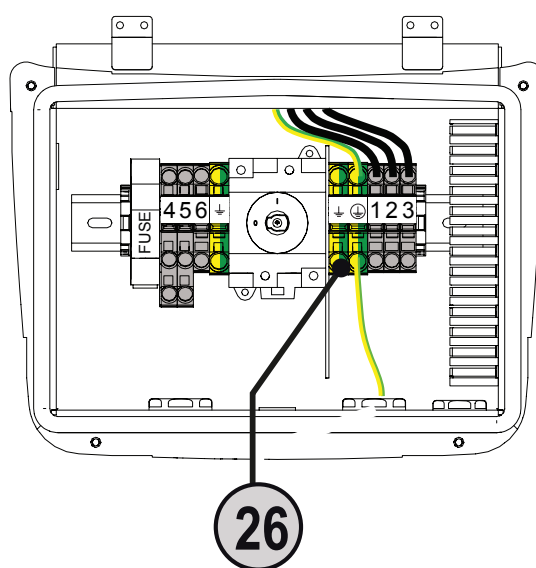

### Earth (ground) connection



**NOTE!** Both NO switchbox and -S versions of inverter include an earth (ground) terminal **24/25** for each wiring system (DC input and AC output circuit) identified by the symbol specified at left on the terminal.

No Switchbox version

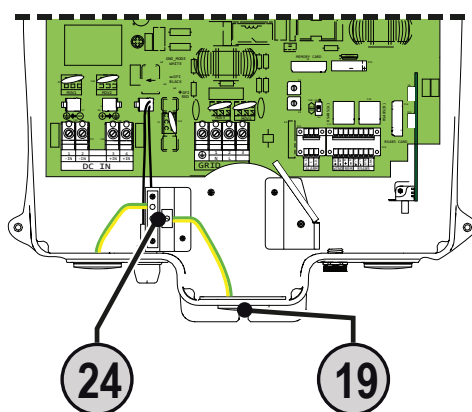

-S Switchbox version

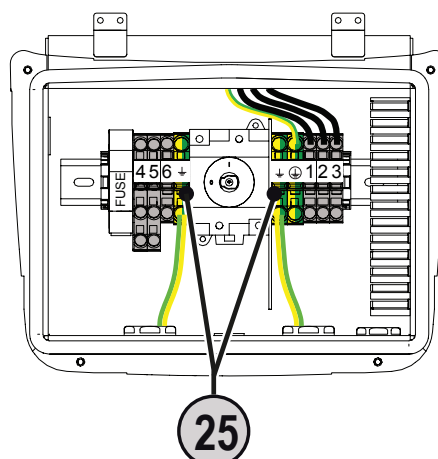

## Grounding configuration of DC inputs



The installer must determine the array ground reference required and configure it appropriately before any connections or testing takes place.

Note that for both the standard version (no switchbox) and -S version (switchbox), the default setting accommodates a negative ground referenced array, and hardware adjustments must be made to accommodate a positive referenced array.

Incorrect configuration may cause damage to the system and photovoltaic panels!

The version of the UNO inverter described by this manual requires one side of the connected PV array to be referenced to ground. The ground reference connection is done internal to the inverter via jumper wiring.

The UNO is provisioned with capability to connect arrays requiring either the POSitive or NEGative reference to ground. The grounding of the inputs is negative configuration by default. As illustrated below, the grounding cable **a02** is connected in position **a03** for negative grounding of the inputs.

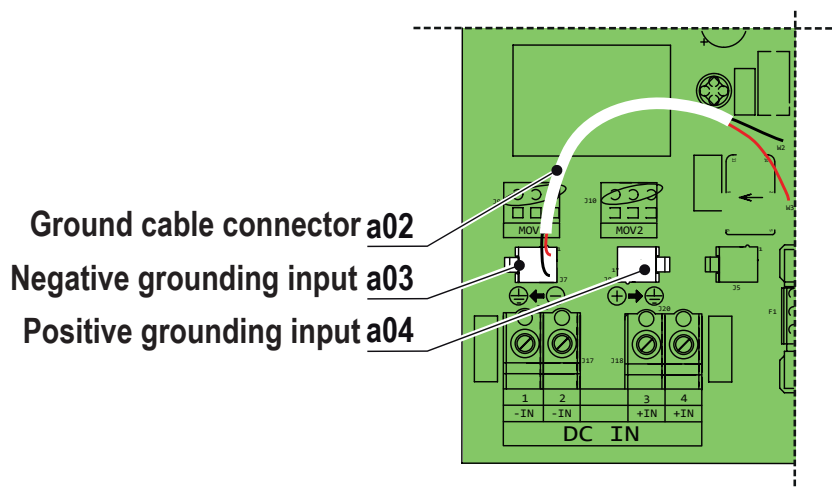

Some photovoltaic panels require a POSitive ground reference and the POSitive side of an array utilizing this type of panel must be referenced to the ground. In the inverter on the main board, move the grounding cable **a02** from the default position **a03** (negative ground) to **a04** (positive ground) for either version, as illustrated below.

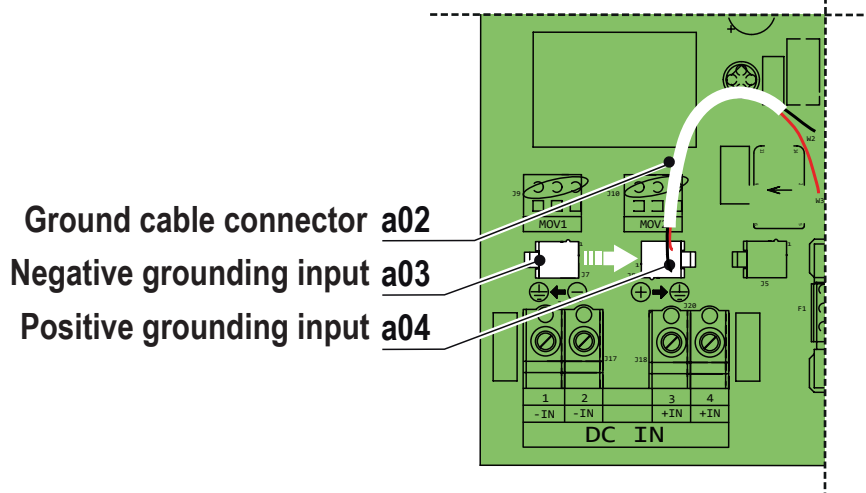

**WARNING!** The PV array wiring must never be referenced to a ground point external to the inverter as this will defeat the GFD control!

## Additional grounding connection in switchbox (-S version)

In addition to moving the ground cable as illustrated above, for the –S version it is necessary to reverse the internal DC connection cables positions 4 and 6, found on the DC terminal block within the switchbox.

-S negative ground (default connection)	-S positive ground connection
<ul style="list-style-type: none"> <li>Position 4: NEGATIVE input poles</li> <li>Position 6: POSITIVE input poles</li> </ul>	<ul style="list-style-type: none"> <li>Position 4: POSITIVE input poles</li> <li>Position 6: NEGATIVE input poles</li> </ul>

NEGATIVE GROUNDING

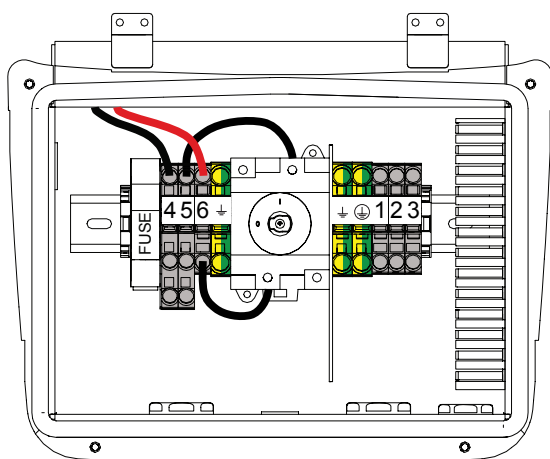

POSITIVE GROUNDING

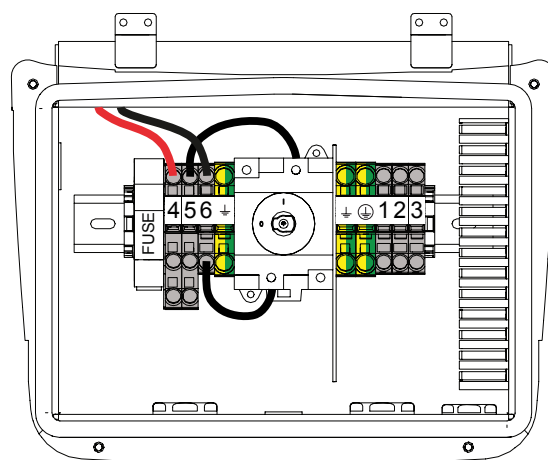

## Connection to PV field (DC side)



**WARNING!** Prior to making any connections to the inverter, to prevent electrical hazards, insure the DC disconnect switch **07** and any external disconnect switch are opened and locked out.

In order to connect the array cables to the inverter, it is necessary to replace the DC plug screw **18** with a 3/4" box connector (thread 14 NPSM) that matches the wiring method chosen (e.g., conduit, flexible conduit, etc.).

The box connector must be "wrench tight" according to NEC requirements.

To maintain the NEMA 4X environmental protection rating, it is recommended that a neoprene gasket be inserted between the box connector and the inverter chassis.

## DC inputs - standard version (no switchbox)

For string connections it is necessary to use the DC input screw terminal block **23**. The maximum wire size range accepted is 6AWG to 12AWG. The two pairs (1+2 and 3+4) of screw terminals are internally connected allowing two strings to be landed and combined into a single input channel.

Where only one feed/string is connected there is no preference as to which terminal, (1 or 2) for negative pole and (3 or 4) for positive pole, is used for the connection.

DC input connections - standard version

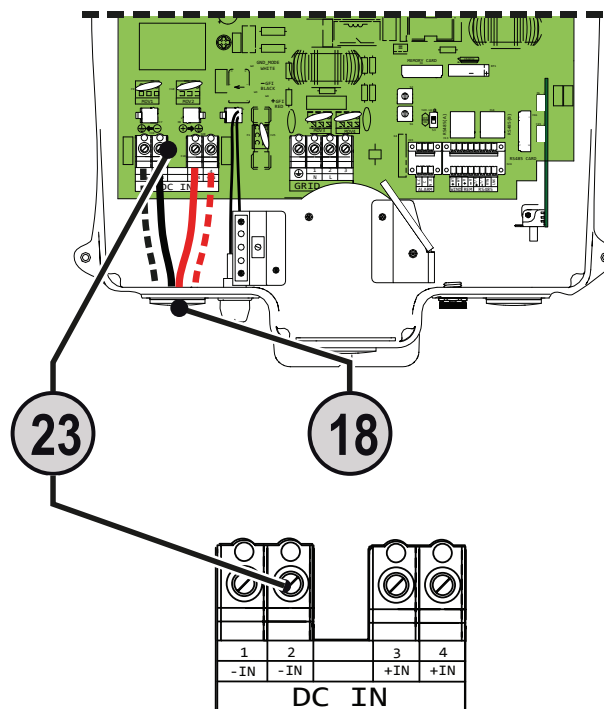

## DC inputs - S version (switchbox)



**NOTE!** For -S versions (switchbox), the DC input connection depends on the grounding configuration.

For the -S model, DC input connections are made after connecting an appropriate raceway to the chassis, pulling the conductors through the raceway and DC cable openings **18**, and connecting them to the DC Terminal Block **14**. Acceptable wire size range is from 12 AWG to 6 AWG.

- Refer to local codes for appropriate wire size.
- Use only copper wire rated at least 90°C.

In the switchbox, connect the DC input cables from the PV string to the DC input terminal block **14** as follows:

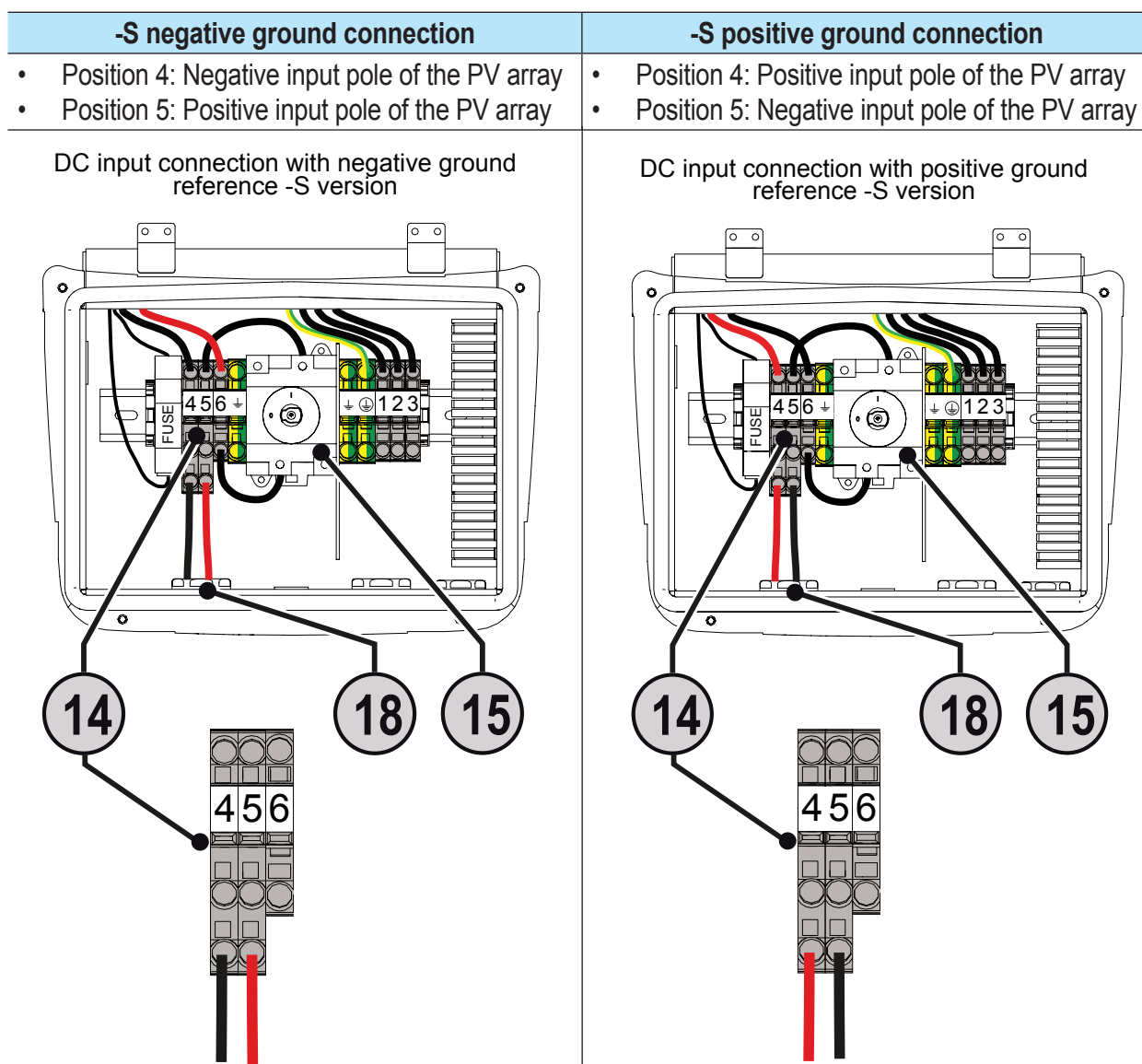

## Grid output connection (AC side)

The cross-section of the AC line conductor must be sized correctly in order to prevent unwanted disconnections of the inverter from the grid due to high impedance of the line that connects the inverter to the power supply point. If the impedance is too high, it causes an increase in the AC voltage that, on reaching the limit set by the country of installation, causes the inverter to switch OFF.

For suitable wire size (AWG), refer to the Canadian Electrical Code, CEC Table 2 and Table 4 for Canada, or NFPA National Electrical Code, Table 310.15(B)(16) (formerly Table 310.16) for US. Use only copper wire rated at least 90° C; range is from 12 AWG to 6 AWG



**WARNING!** The DC disconnect switch **07** disconnects **ONLY** the DC current from the photovoltaic panels when the switch is open in the OFF position. It **DOES NOT** disconnect the AC connection to the grid. To disconnect the inverter from the AC grid, an external, customer supplied AC switch must be used.



Connect the AC wires on the inverter AC terminal block (1, 2, 3) based on the utility voltage configuration table below.

	208V~ 3PH - Δ			240V~ SPLIT-PHASE			277V~ 3PH - Y		
TERMINAL	1	2	3	1	2	3	1	2	3
WIRE	L1	L2	-	L1	L2	N	N	L1	-



**NOTE!** In order to connect the AC grid wiring to the inverter it is necessary to replace the AC plug screw **19** with a 3/4" box connector (thread 14 NPSM) that matches the wiring method chosen (e.g., conduit, flexible conduit, etc.).

The illustrations on the following page show the AC connection for both versions of the inverter. The dotted line indicates where a wire can be connected if chosen.

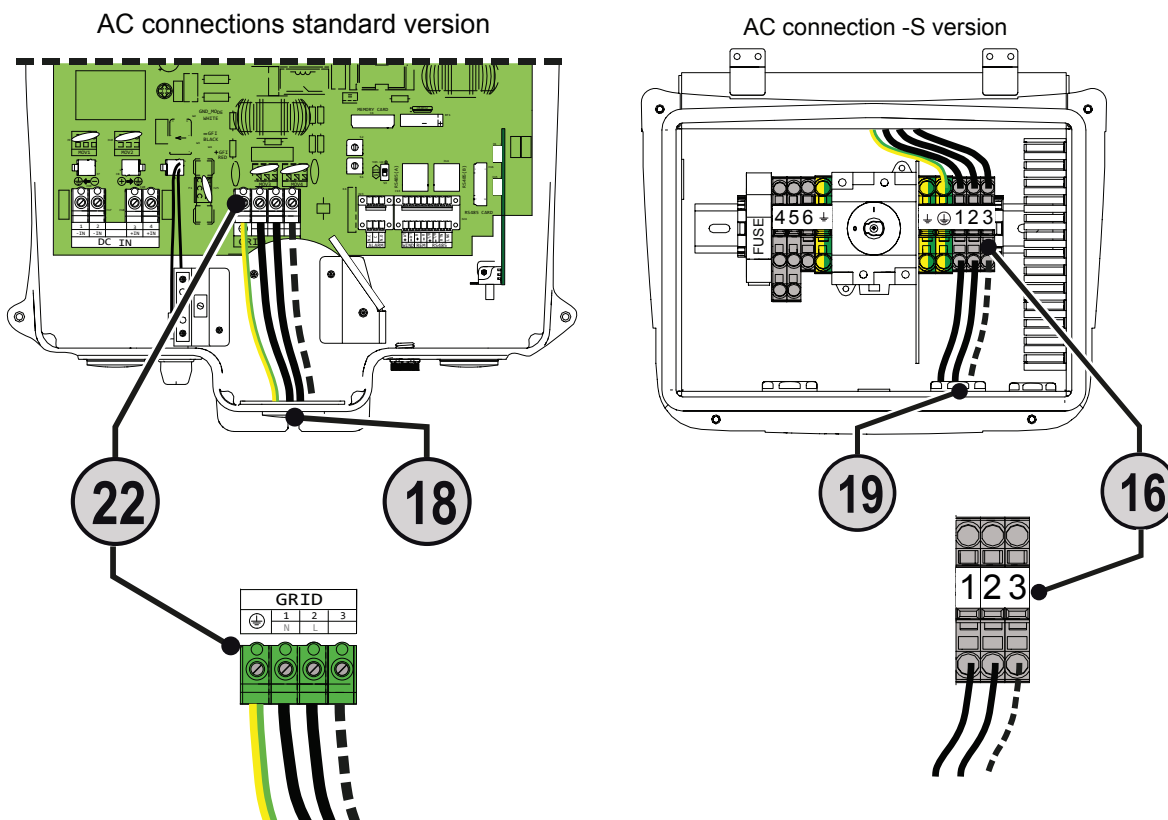

**NOTE!** Before connecting the inverter to the distribution grid, the grid standard for the country of installation must be set following the instructions below. Before turning the rotary switches make sure the inverter is switched OFF!

## Grid standard/country setting

The default setting is 0 / 0 and means no grid standard is selected and the display language is English. (In this case, the “Set Country” message will appear on the display).

- Refer to selections below for the appropriate choice of grid parameters.
- These are programmed into the inverter using the two rotary switches shown.
- The language of the display menu will also be defined by the grid standard chosen.
- Adjust the dials using a small flat head screwdriver and move the dial of the switches to line up with selected positions on the rotary dials.
- If a switch position entered is not assigned to a grid standard, “Invalid Selection” appears on the display.

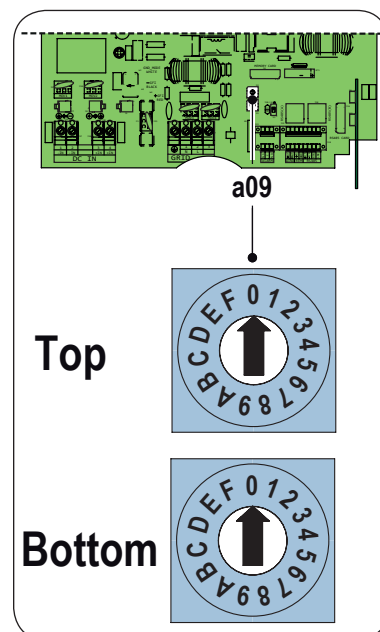

Grid Settings	Top Switch	Bottom Switch	Display Menu Language
UL 1741 @208V Single Phase	0	2	English
UL 1741 @240V Split Phase	0	3	English
UL 1741 @277V Single Phase	0	4	English



## Communication and signal wiring connections

All field wiring connected to signal circuits (ALARM, REM & RS-485) should be routed inside the chassis and secured such that it cannot contact either the AC or DC wiring. It is prudent to use a UL/CSA certified cable (e.g., Belden #3106A), and it is good practice to protect the external run of this cable by means of a suitable raceway.

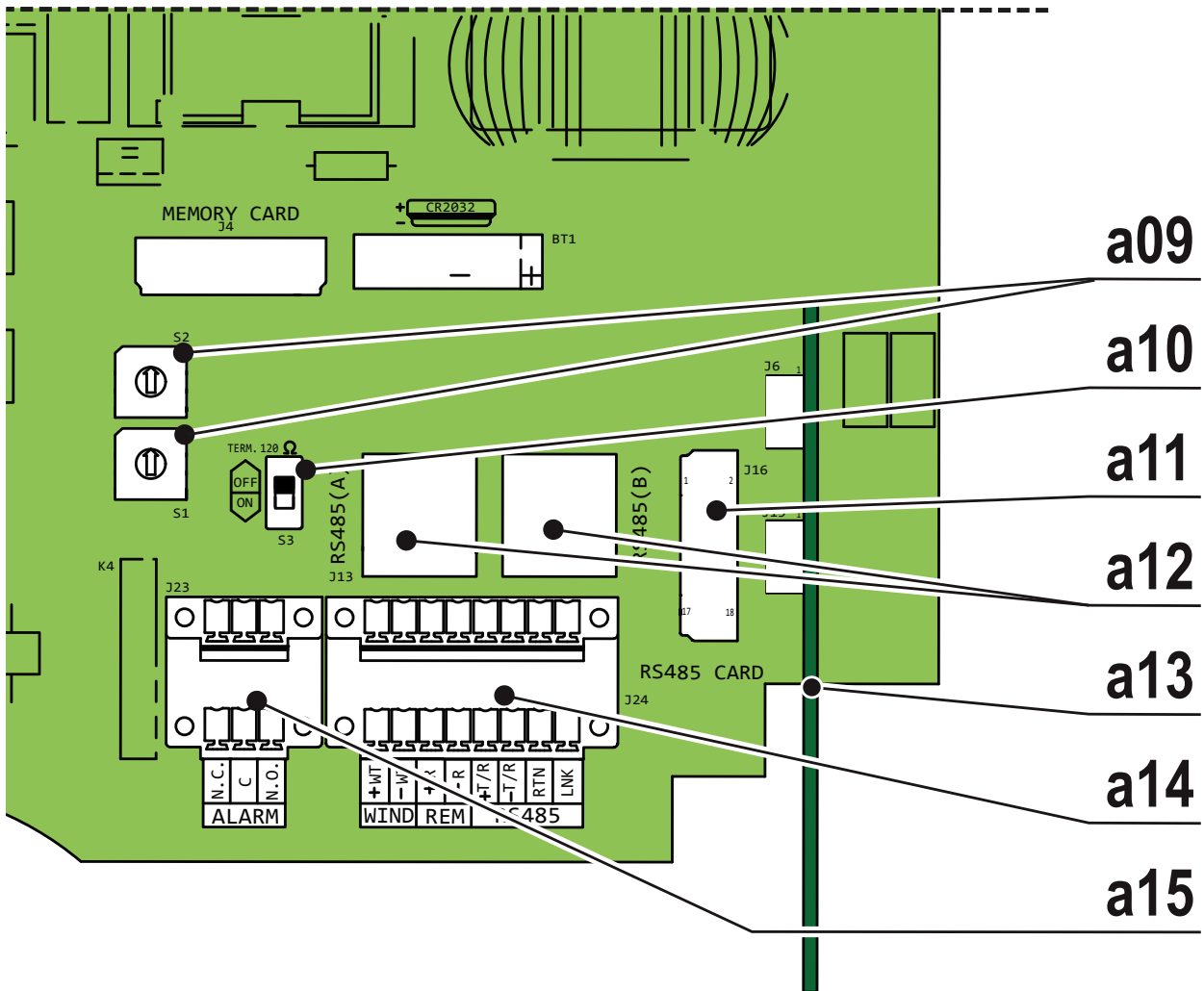

Ref#	Description
a09	Grid standard rotary switches
a10	Termination resistance switch S3
a11	RS-485 communication card housing
a12	Connection of the RS-485 line on RJ45 connector
a13	Radiomodule board slot
a14	Remote control, RS-485 terminal
a15	Multi-function relay terminal

Each cable connected to the communication and control signals must pass through the signal conduit **20** and signal wiring duct **17**. The signal cables are then connected to the main board inside the inverter by means of the terminal connectors supplied.



**NOTE!** In order to connect the communication wiring to the inverter, it is necessary to replace the signal plug screw **20** with a 1/2" box connector (thread 14 NPSM) that matches the wiring method chosen (e.g., conduit, flexible conduit, etc). Tighten to 2.23 in/lbs torque to maintain the NEMA 4X environmental protection rating.

Communication and signal wire routing  
in standard version

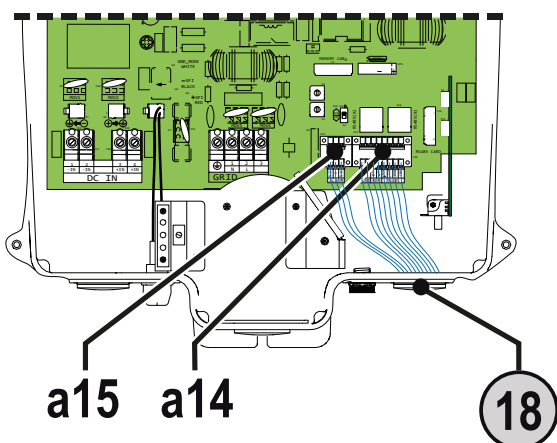

Communication and signal wire routing  
in -S version

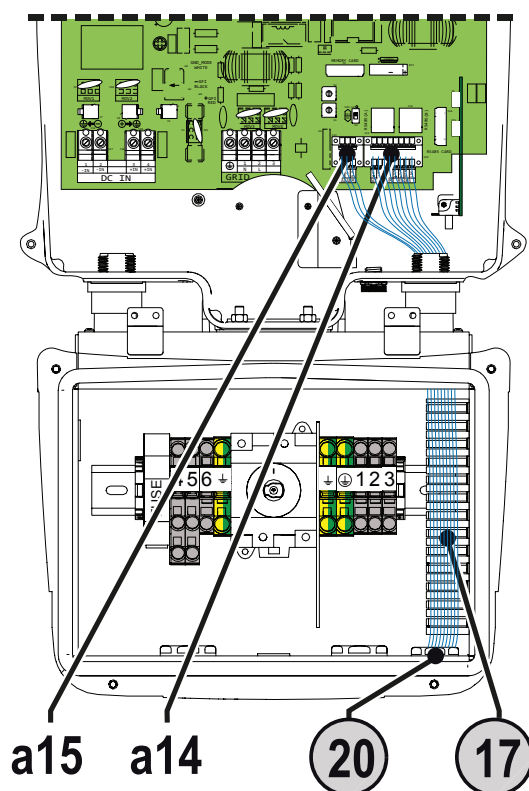

## Serial communication connection (RS-485)

The RS-485 communication line connects the inverter to the monitoring devices and may be "daisy-chained" (in-out) among multiple inverters. The RS-485 connecting cables can use both the terminal connections **a14**, as well as the RJ45 connectors **a12**, to connect to the dedicated port.

To connect the RS-485 cables to the communication card, remove the threaded plastic plugs from the signal cable openings **11** and replace with the appropriate water-tight conduit connector. Whether these cables need to be protected by conduit depends on the applicable wiring code.

If no conduit is used, the cables should be brought into the wiring box via a 1/2" box connector with rubber cable glands to maintain NEMA 4X rating.

If conduit is used, run the appropriate raceway and terminate it to the wiring box chassis using a conduit connector that matches the raceway. The conduit must be terminated at one of the two 1/2" signal openings 11.

If the terminal blocks are used, the signals RTN, +T/R and -T/R (shown below) have to be cabled. If the RJ45 plugs are used, the pin-out is shown at the bottom of the page.

Use a cable designed for use with RS-485 communications, which has a twisted pair for the +/-T/R signals and a third conductor used as a return (RTN). The figure below shows a cable with two twisted pairs where one pair is shorted together to create a RTN line. Another choice such as Belden 3106A, is a data cable wire with one twisted pair, one ground conductor, and a shield with drain wire (equivalent).

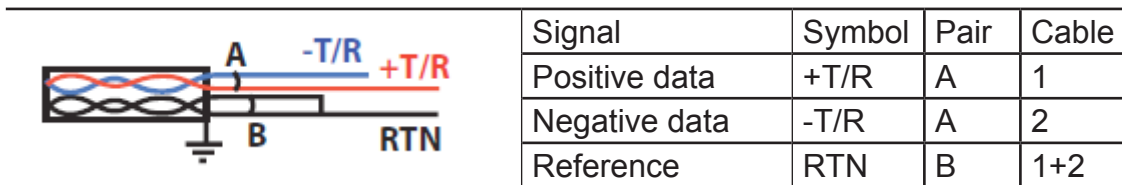

Continuity of the shield in the RS-485 cable is important for low noise on the line, particularly for large plants with multiple inverters. For best results the shield must be tied to ground at only one point on the line, typically at one end or the other.

The shield wiring must be continuous as it passes from one inverter to the next on a daisy chain but must not be tied to ground at these junctions.

- If using standard multi-conductor RS-485 cable, locate the mating connectors (provided) for the terminal block **a14**.
- Connect the three RS-485 leads (-RTN, +T/R, -T/R) to the mating connector corresponding points.
- Attach the mating connector to **a14** terminal block at corresponding points.

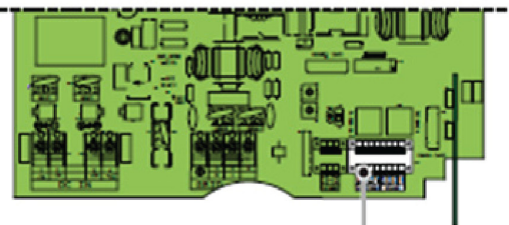

a14

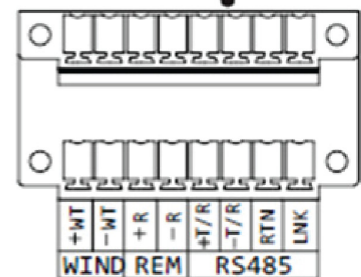

For systems with multiple inverters, two parallel terminal rows are on the terminal block and two mating connectors are included for this purpose.



**CAUTION HAZARDOUS VOLTAGE** – The ±WT (WIND) terminals are not isolated and can have hazardous voltages present. These terminals must not be utilized for any purpose in a PV installation (for use with wind models only).

The RJ45 connectors (A) and (B) available for the RS-485 communication, are equivalent to each other and can be used interchangeably for the input or for the output of the line to create the daisy chain connection of the inverters. If the RJ45 plugs are used, the pin-out is reported below.

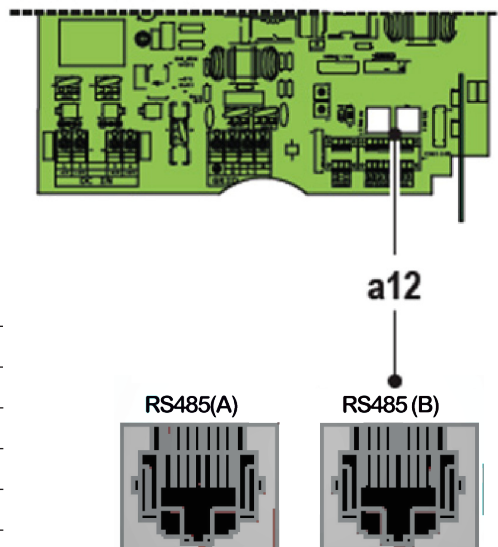

**Pin-out of RJ45 connector plugs**

	Pin #	Function
TOP	1, 2, 6, 8	Not Used
	3	+ Data Line (+TR)
FRONT	4	Remote OFF (+R)
	5	- Data Line (-TR)
	7	Signal Return (RTN)

## Daisy chain units for connection to a monitoring system

The RS-485 terminal block connectors **a14** or RJ45 connectors **a12** can be used to connect a single inverter or implement a multi-unit wiring configuration (daisy chain). The recommended length of total communication cable line for all inverters in the system is 1,000 meters (1094 yards) or less.

Depending on the type of computer used, the cable line adaptor can be RS-485 to RS232 or RS-485 to USB. In order to ensure optimum communication on the RS-485 line, it is recommended to connect the RS-485 converter to a location between the first unit in the daisy chain or multi-unit system configuration and the computer; not in between two inverters in the series.

Using the appropriate cable, daisy chain the inverter units RS-485 lines in a series. On the last inverter in a daisy chain, or on a single inverter, activate the termination resistance for the communication line by moving the S3 switch **a10** down into the ON position. All other inverters in the daisy chain will have the S3 switch **a10** placed up in the OFF position.

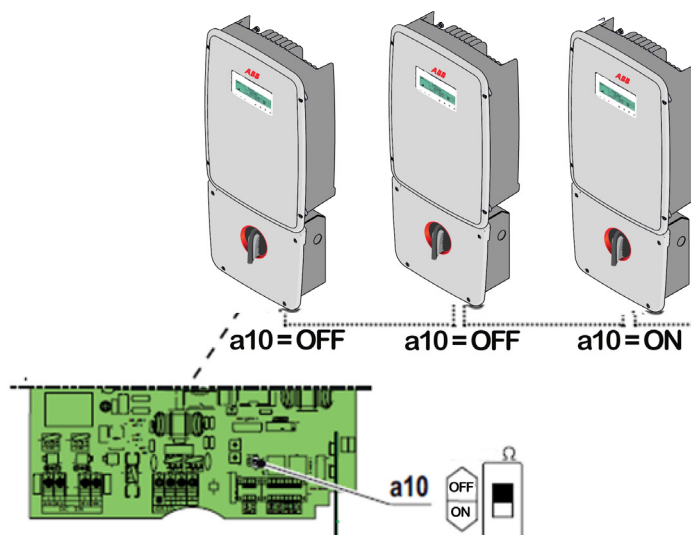

## Addressing each inverter

When multiple inverters are connected on a single RS-485 bus, it is necessary to assign a different RS-485 address to each unit. The address on the inverter is set through the user interface on the display panel (section 4).

Address values are assigned manually using any value in the range 2 to 63. Set a different RS-485 address for each inverter of the chain. The default setting for the RS-485 address is 2, and termination switch S3 (**a10**) in the OFF position.



No more than 63 inverters can be connected on a single RS-485 link. The number may be less depending on the data logger used. Do NOT to exceed a length of 3,300 ft/1000m for the RS-485 communication line.



## Monitoring system via serial (RS-485)

The RS-485 line can be connected to various monitoring devices that can be in local or remote mode:

- Local monitoring from PC with a PVI-USB-RS485\_232 adaptor and Aurora Communicator software.
- Local monitoring from a remote display such as the PVI-DESKTOP device with a PVI-USB-RS485\_232 adaptor.

For local monitoring, a PVI-USB-RS485\_232 brand adaptor is recommended for connection between the first unit of the daisy-chain and the computer.

Equivalent RS-485 to RS-232 adapters found on the market can also be used for the same purpose; however, they have not been specifically tested in order to guarantee correct operation of the connection. These devices may also require external termination impedance, whereas this is not necessary with the PVI-USB-RS485\_232.

## Monitoring system via RADIOMODULE

The PVI-RADIOMODULE Zigbee board is an accessory for the wireless transmission of data via radio waves to a monitoring device.

It is mounted vertically on the main board and connected to the inverter via two connectors anchored to the enclosure using two screws. It is necessary to install the antenna outside the inverter using the signal connector conduit openings **11** as illustrated on the following page.

No Switchbox Version

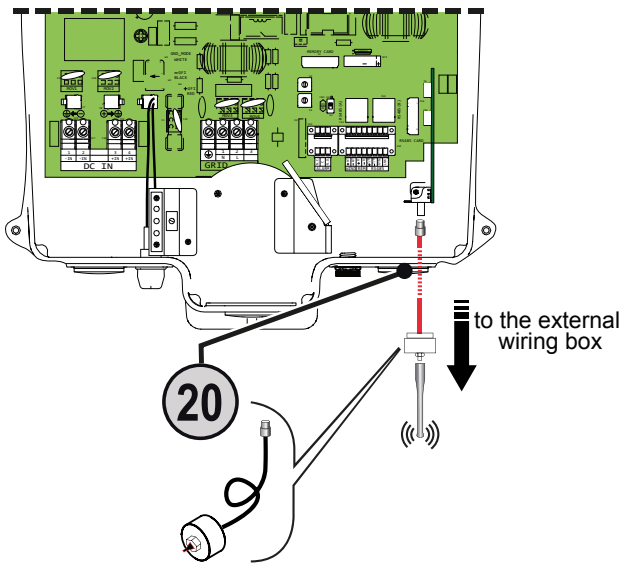

-S Switchbox Version

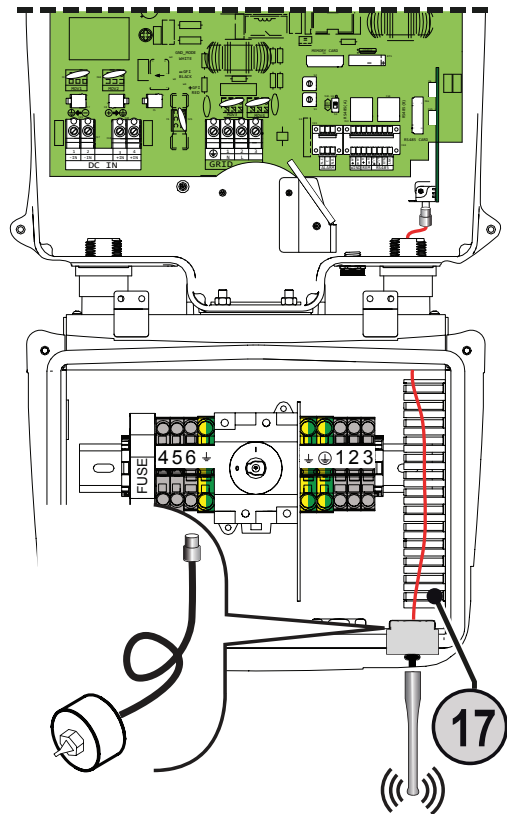

NOTE! With the installation of the RADIOMODULE in the unit, apply the FCC label supplied with the inverter as shown below, underneath the regulatory label. The FCC label contains the FCC mark and FCC ID of the RADIOMODULE.

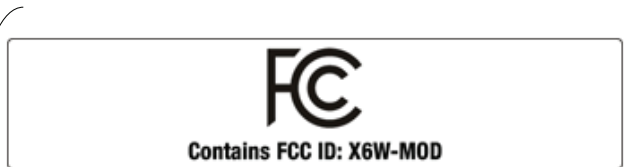
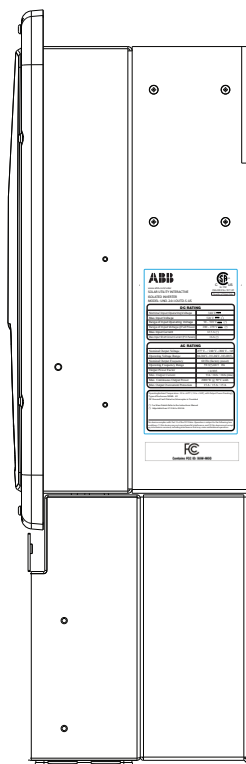

## Configurable relay connection (Alarm)

The inverter has a multi-function relay accessible at terminal block **a15** and it is provisioned with a removable screw-terminal mating connector to simplify connections to the terminal block.

The relay output can be configured to activate a visual and/or audible alarm or be utilized by another control such as a building control system. The signal logic can be controlled by the user by using either the normally open (N/O) contact – or the normally closed (N/C) contact.

The relay can be used in four different operating modes which are set using the associated Settings menu of the inverter display. See section 4 for descriptions and instructions to program the operating mode.

The device to be connected to the relay can be of different types (light, sound, etc.) but must comply with the following requirements:

<b>Alternating current</b>	Max Voltage: 240 Vac	Max Current: 1 A
<b>Direct current</b>	Max Voltage: 30 Vdc	Max Current: 0.8 A

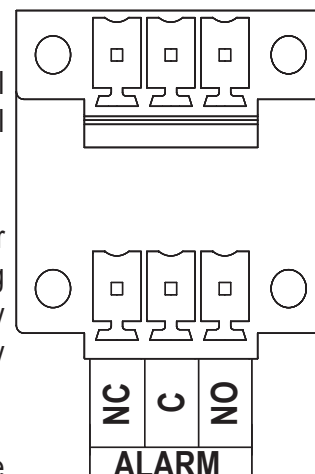

## Remote control connection

The connection and disconnection of the inverter to and from the grid can be controlled remotely through an external control. The function must be enabled in the associated Settings menu (section 4). If the remote control function is disabled, the inverter automatically switches on and off in response to appropriate conditions.

If the remote control function is enabled from the menu, the switching on of the inverter also depends on the state of the R\_ON/OFF terminal compared to the GND terminal present on the connector **a14**.

If the function is enabled as noted above :

- With the +R and -R terminals open (floating) the inverter operates normally.
- With the +R and -R pins shorted together the inverter is disconnected from the grid and a “Remote Control OFF” message is shown on the display.

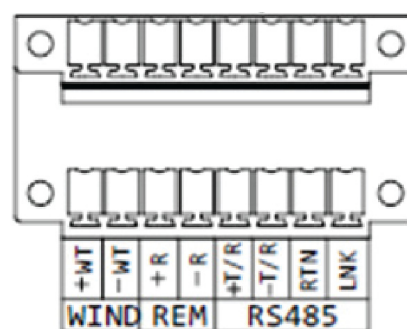

Since this is a low-level digital input, the wiring to the +R, -R terminals is typically small (18AWG to 24 AWG).



**CAUTION HAZARDOUS VOLTAGE** – The  $\pm$ WT (WIND) terminals are not isolated and can have hazardous voltages present. These terminals must not be utilized for any purpose in a PV installation (for use with wind models only).





## Monitoring and data transmission



One of the first rules for preventing damage to the equipment and injury to the operator is to have a thorough knowledge of the user interface operations.

ABB cannot be held responsible for damage to the equipment or the operator if caused by incompetence, insufficient qualifications or lack of training.

Normally, the inverter operates automatically and does not require manual intervention. When there is not enough sunlight to supply power for export to the grid, (e.g. during the night) it disconnects automatically and goes into stand-by mode.

The operating cycle is automatically restored when there is sufficient sunlight. At this point, the lights on the LED panel will indicate this state.

## Types of data available

The inverter provides two types of data which are accessed through the appropriate interface software and/or the LCD.

### Real-time operating data

Real-time operating data can be transmitted on request through the communication lines and are not recorded in the inverter. For data transmission to a computer, download the free Aurora Manager Lite software from the website.

### Internally stored data

The inverter internally stores a set of data that is necessary for processing statistical data which includes an error log with time stamps.

## User interface

The inverter is able to provide operation information through the following:

- Warning lights (LEDs).
- Liquid Crystal Display (LCD) for displaying operating data.
- Data transmission on dedicated RS-485 serial line. The data can be collected by a PC (using the signal converter PVI-USB-RS485\_232) or a data logger equipped with an RS-485 port (PVI-DESKTOP). Contact customer service with any questions regarding the compatibility of the devices.

## Display and keypad

There are three indicators on the LED panel and four buttons on the keypad. LEDs indicate the operating state of the inverter. The keypad is used to review data on the cyclical display area **b10** and access the data logged internally on the UNO, using the menus described in this section.

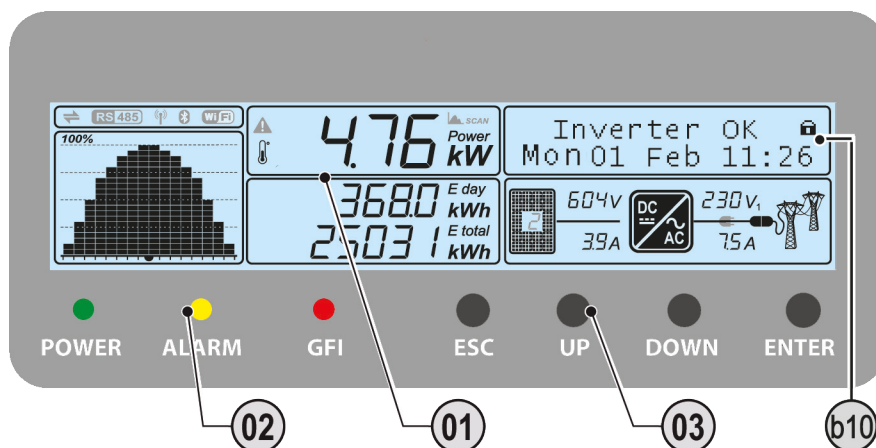

LED	Description
Green POWER LED	Indicates that the inverter is working correctly. This LED flashes while the grid is being checked during start up . If a valid grid voltage is measured, the LED stays on continuously, provided there is sufficient sunlight to activate the unit. If not, the LED continues to flash until there is sufficient sunlight for activation. During this phase the “Waiting for Sun” message is displayed in area b10.
Yellow ALARM LED	Indicates that the inverter has detected an anomaly; the type of problem is shown in the display area b10.
Red GFI LED	The GFI (ground fault indicator) LED indicates that the inverter has detected a ground fault on the DC side of the PV array. When this fault is detected, the inverter immediately disconnects from the grid and the relevant error warning appears in the display area b10.
Keypad button	Description
ESC button	Use the ESC button to access the main menus, exit a mode or go back.
UP button	Use the UP button to read the data on the display by scrolling upwards, or to increase the set value during data entry.
DOWN button	Use the DOWN button to read the data on the display by scrolling downwards, or to decrease the set value during data entry.
ENTER button	Press ENTER to confirm the operation or to enter the set data item.

























During operation, the display cycles through available data points, updating every five seconds. Screens may be scrolled manually by pressing the UP and DOWN buttons on the keypad. Pressing the ESC key gives access to the three main menus: Statistics, Settings, and Information. To return to the preceding menu, press the ESC key.

The three menus can be accessed with just the array connected. Some parameters (e.g., current, voltage, power, partial energy, lifetime energy etc.) are available only after grid connection. Activation of cyclical scrolling will be indicated by two arrows in the top left corner of the two-line display. Scrolling can be blocked by pressing the ENTER key until a padlock symbol appears.

## LED indicators

In their various combinations, the LEDs can indicate conditions that are different from the single one. The table below shows the possible combinations of activation of the LEDs in relation to the operating state of the inverter.

Warning and Error messages referenced below are described in troubleshooting, section 5.

LED BEHAVIOR			
LED off	LED on	LED flashing	any condition
			
LEDs Status	Operational Status	Remarks	
1 green:  yellow:  red: 	Inverter is not operating	Input voltage less than 50Vdc at the input	
2 green:  yellow:  red: 	Inverter is initializing, loading settings and performing grid check	Transition status while operating conditions are checked	
3 green:  yellow:  red: 	Inverter is powering the grid	Normal operation	
4 green:  yellow:  red: 	Inverter is shut down because of a GFI fault	Ground fault has been detected	
5 green:  yellow:  red: 	Inverter detected a fault	The fault can be inside or outside the inverter. See the alarm code appearing on the LCD	
6 green:  yellow:  red: 	Installation phase: inverter is disconnected from grid	During installation it refers to setup of the address for RS-485 communication	
7 green:  yellow:  red: 	Inverter is disconnected from grid	Indicates a missing grid connection	



# Descriptions of symbols and display fields

- b1 - Indicates the transmission and reception of data through the RS485 line.
- b2 - Indicates the presence of the RS485 communication line.
- b3 - Reports the presence of a line of radio communication (Radiomodule card installed)
- b6- Warning symbol indicates presence of power derating, input voltage out-of-range or power limitation.
- b7- Reports a derating of power due to high internal temperature.
- b8- Instaneous power generated for the grid.
- b9- MPPT SCAN function activated
- b10- Lines of test for the cyclical display of inverter parameters, error codes and menu navigation.

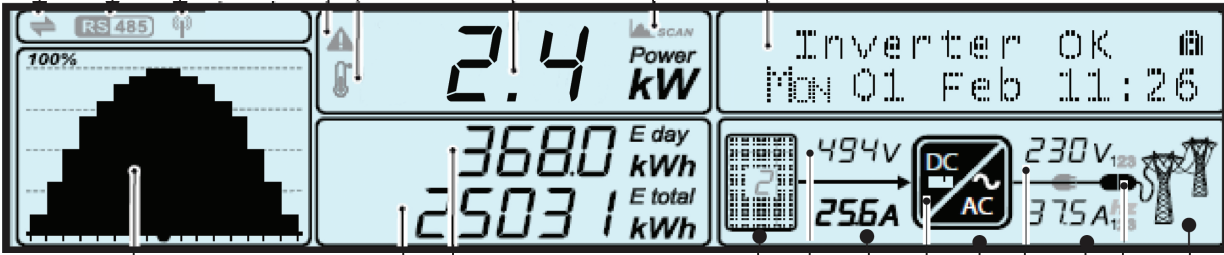

- b11-Graph of the power fed into the grid (from 0to 100%). The time scale is settable to 8/16/24 hours.
- b12- Display the total energy produced since installation of the inverter.
- b13-Displays the energy produced over a day.
- b14-Indicates PV array voltage is higher than the Vstart of the inverter
- b15-Input voltage (DC)
- b16-Input current (DC)
- b17-Indicates DC/DC input current
- b18-Indicates the circuit part for conversion from DC to AC
- b19-Output voltagefrom the highlighted phase
- b20-Output current from the highlighted phase
- b21-Connection to the grid
- b22-AC voltage

## Cyclical display of general information

The graphic display area **b10** consists of 2 lines with 16 characters per line. When moving through the menu using the buttons of the keypad, area **b10** is used to:

- display the operating state of the inverter and the statistical data
- display the service messages for the operator
- display the alarm and fault messages for the operator
- navigate the menus

Pressing the ESC button allows access to the three main menus, STATISTICS, SETTINGS and INFORMATION. ESC is also used to cancel an entry or return to the previous menus.

The UP and DOWN buttons of the keypad are used to move through a menu and change menu settings by increasing or decreasing the settable values.

The ENTER button is used to open the menu choices, make a selection and confirm a change in adjustable values.

During regular operation the display will cycle through the general information shown at right.

Cycling is indicated by two arrows in the top right corner of display area **b10**.

Scrolling can be stopped by pressing the ENTER button until a padlock symbol appears.

When locked, the current information displayed will remain on screen

Press and hold the ENTER button until the arrows are displayed to unlock the screen and cycle through the display.

### GENERAL INFORMATION (cycle view)

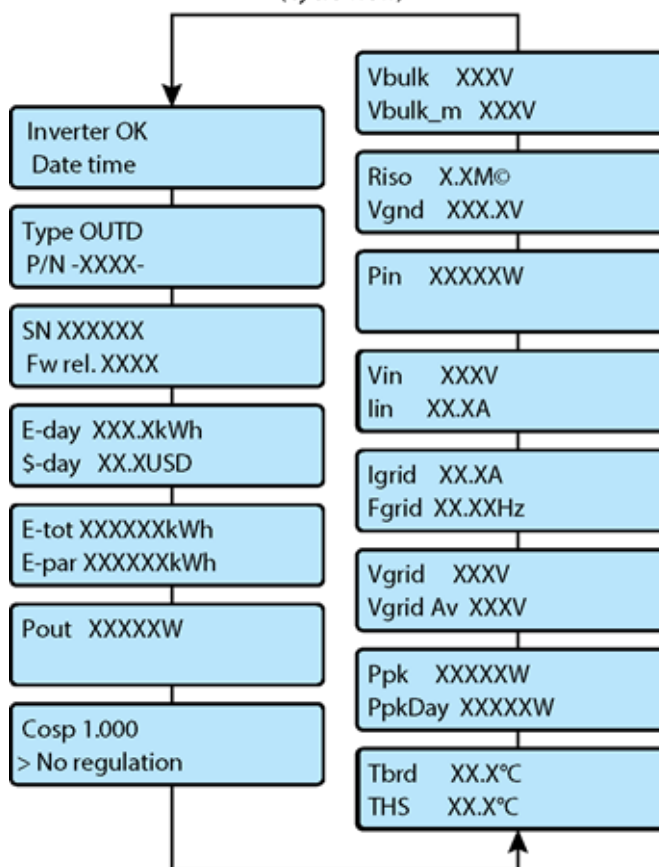

The three main menus that enable monitoring of the inverter's operations are outlined and described on the following pages. Press the ESC button to access the menus from the general information screens. Use the UP and DOWN keys to scroll through the three menus and press ENTER to make a selection.

## Statistics menu

The Statistics menu is a view only display of internally logged inverter data.

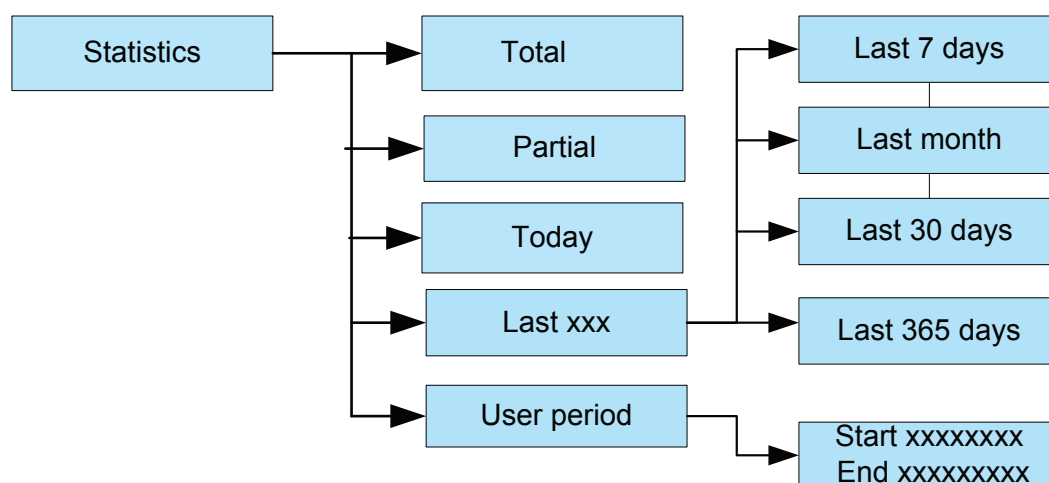

**Total** - Displays the total statistics for lifetime operation:

- Time: Total operating time
- E-tot: Total energy produced
- Val. : Total production value, calculated with the currency and conversion coefficient set in the relevant section of the SETTINGS menu
- CO2: Amount of CO2 saved

**Partial** - Displays partial statistics using a counter that can be reset\*:

- Time: Partial operating time since the counter was activated
- E-par: Partial energy produced since the counter was activated
- PPeak: Peak power value measured since the partial counter was activated
- Val. : Partial production value calculated with the currency and conversion coefficient set in the relevant section of the SETTINGS menu
- CO2 : Amount of CO2 saved daily since the counter was activated

\* To reset all the counters of this submenu, press the ENTER button and hold for 3 seconds until a beep is heard.

**Today** - Displays the daily statistics:

- E-day: Daily energy produced
- PPeak: Daily peak power value
- Val. : Daily production value calculated with the currency and conversion coefficient set in the relevant section of the SETTINGS
- CO2: Amount of CO2 saved today

**Last 7 days - Last month - Last 30 days - Last 365 days -**

Select any one of the above time periods to view the following information:

- E-##: Energy produced over the period selected
- Val. : Economic gain over the period selected
- CO2: Amount of CO2 saved for the period selected

**User period** - Displays the statistics for a period selected by the user. Use the display keys to set the start and end date of the period as follows:

- Scroll to *User Period* and press ENTER to open the *Start/End* date screen.
- Use ENTER to move from one field to the next (from left to right).
- Use ESC to go back to the previous field (from right to left).
- Press ESC repeatedly to go back to the previous menus.

To set the day: Press DOWN to scroll numbers from 31 to 1, UP to scroll from 1 to 31.

To set the month: Press DOWN to scroll months from December to January.; UP to reverse.

Once the start and end dates for the user periods have been selected, the following data is available:

- E-use: Energy produced during the selected period
- Val. : Value of production for the selected period calculated with the currency and conversion coefficient set in the relevant section of the SETTINGS menu
- CO2 : Amount of CO2 saved during the selected period

## Settings menu

The Settings menu requires a password which allows access to configuration and modification of the basic inverter settings.

- Press ESC to open the main menus.
- Scroll DOWN to *Settings* and press ENTER.
- The password screen is populated in the display.
- The default password is 0000; pressing ENTER four times loads four zeroes into the display and opens the submenus outlined below.

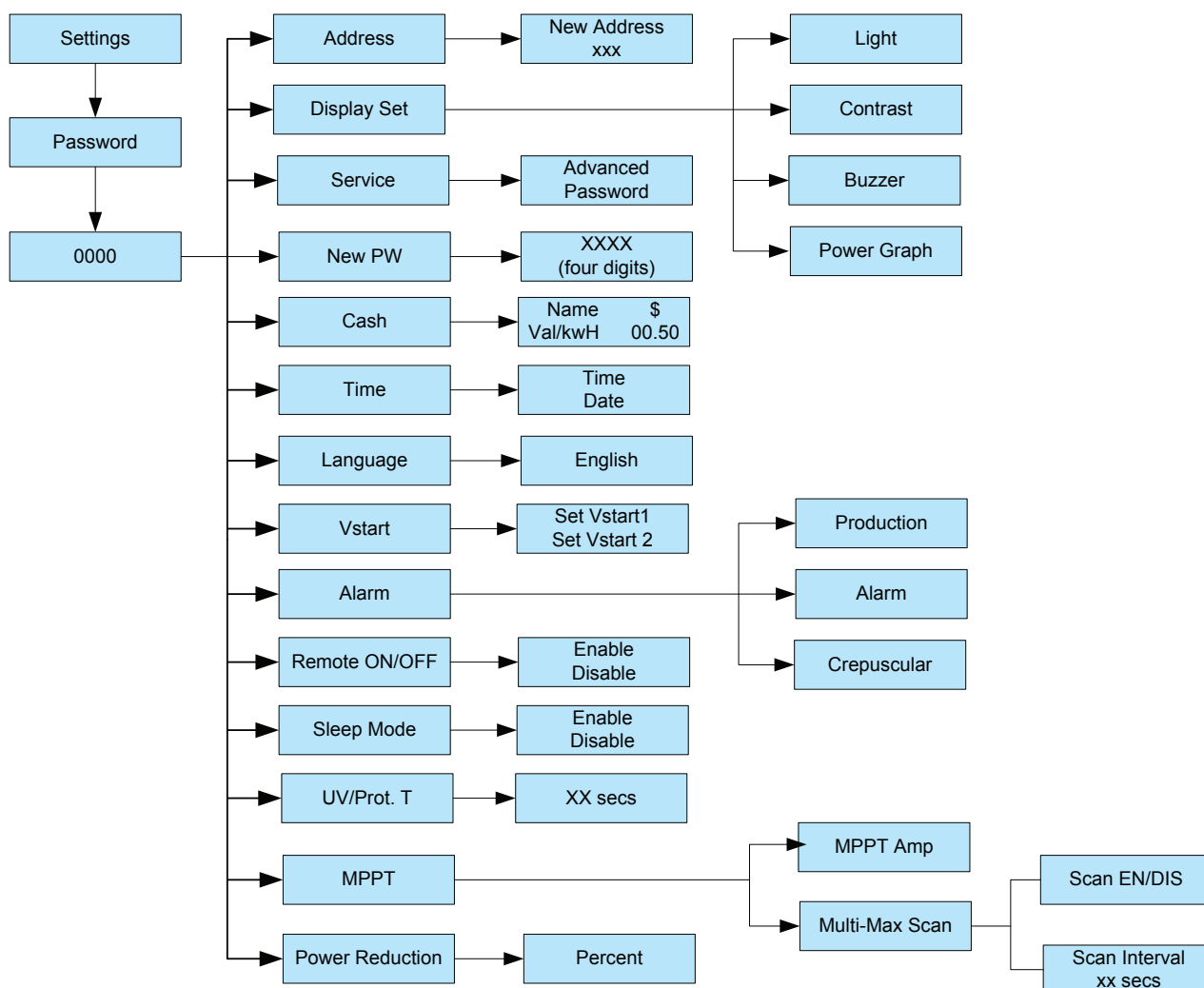

**Address** - Used to set the address for the serial communication of inverters connected to the RS-485 line.

The addresses that can be assigned are 2 to 63. Use the UP and DOWN buttons to scroll the numerical scale. "Auto" address is equivalent to address=1 and can be used on only one of the inverters in a daisy chain connection



No more than 63 inverters can be connected to a single RS-485 link. The number may be less depending on the data logger used.

**Display Settings** - Used to set the characteristics of the display

1. Light: setting of the mode and adjustment of the brightness of the display
  - Mode:
    - ON: Light always on
    - OFF: Light always off
  - Auto: Automatic light control. The light comes on whenever a button is pressed and stays on for 30 sec, after which it gradually goes out.
  - Intensity: adjustment of display brightness (scale from 0 to 9)
2. Contrast: adjustment of display contrast (scale from 0 to 9)
3. Buzzer: button sound setting
  - ON: the sound of the buttons is activated
  - OFF: the sound of the buttons is deactivated
3. Power Graph: Time range: 8 H, 16 H, 24 H

**Service** - This section of the menu is reserved for installers and it is necessary to have a dedicated password. See troubleshooting section 5, for instructions to obtain the service level password.

The Service menu can be used to adjust the voltage and frequency trip limit and trip time parameters according to the grid requirements of the installation locale. This inverter has been factory programmed to automatically disconnect from the utility distribution system in compliance with UL 1741 and IEEE1547 specifications. Default voltage and frequency trip limit and trip time settings to comply with these standards are shown in the table on the following page.

The table lists the default and adjustable parameters available in the *Service* submenu. Using the UP and DOWN keys on the inverter display panel, scroll to select the values for modification.



ABB cannot be held responsible for any negative effects resulting from modifications of inverter set points.

The set points in the table below should only be changed with the written permission of the local utility.

Changes to the voltage and frequency trip limit and trip time parameters **MUST** be done by a qualified contractor or authorized personnel.

Improper values entered could cause bodily harm and cause the inverter to shut down.



Display	Description
Set U>>	Max grid voltage. Grid overvoltage (OV) threshold (extended range).
Set U<<	Min grid voltage. Grid undervoltage (UV) threshold (extended range).
Set F>>	Max grid frequency. Grid over-frequency (OF) threshold (extended range).
Set F<<	Min grid frequency. Grid under-frequency (UF) threshold (extended range).
Set U>	Max grid voltage. Grid overvoltage (OV) threshold.
Set U> (10 min)	Overvoltage (OV) protection of the average grid voltage value.
Set U<	Min grid voltage. Grid undervoltage (UV) threshold.
Set F>	Max grid frequency. Grid over-frequency (OF) threshold.
Set F<	Min grid frequency. Grid under-frequency (UF) threshold.
Set Uconn>	Max grid voltage for connection. Maximum voltage threshold for the grid connection.
Set Uconn<	Min grid voltage for connection. Minimum voltage threshold for the grid connection.
Set Fconn>	Max grid frequency for connection. Maximum frequency threshold for the grid connection.
Set Fconn<	Min grid frequency for connection. Minimum frequency threshold for the grid connection.
Set Time U>>	Grid overvoltage (OV) threshold (extended range) protection trip time.
Set Time U<<	Grid undervoltage (UV) threshold (extended range) protection trip time.
Set Time F>>	Grid over-frequency (OF) threshold (extended range) protection trip time.
Set Time F<<	Grid under-frequency (UF) threshold (extended range) protection trip time.
Set Time U>	Grid overvoltage (OV) threshold protection trip time.
Set Time U<	Grid undervoltage (UV) threshold protection trip time.
Set Time F>	Grid over-frequency (OF) threshold protection trip time.
Set Time F<	Grid under-frequency (UF) threshold protection trip time.
Set Time Conn 1	Grid checking time before connection after generic fault. Grid check interval before the connection or after a generic fault.
Set Time Conn 2	Grid checking time before connection after grid fault. Grid check interval before the connection after a grid fault.
Disable U>>	Enable/disable Grid overvoltage (OV) threshold (extended range).
Disable U<<	Enable/disable Grid undervoltage (UV) threshold (extended range).
Disable F>>	Enable/disable Grid over-frequency (OF) threshold (extended range).
Disable F<<	Enable/disable Grid under-frequency (UF) threshold (extended range).
Disable U>	Enable/disable Grid overvoltage (OV) threshold.
Dis. U> (10 min)	Enable/disable the overvoltage (OV) protection of the average grid voltage value.
Disable U<	Enable/disable Grid undervoltage (UV) threshold.
Disable F>	Enable/disable Grid over-frequency (OF) threshold.

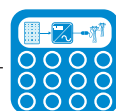

Display	Description
Disable F<	Enable/disable Grid under-frequency (UF) threshold
U>(10 min) Der.	Enable/disable the U> (10Min) protection threshold.
Slow ramp	Enable/disable the gradual feeding of power after the grid connection.
OF Derating	Enable/disable the power derating mode in the event of grid over-frequency.
OF Der. Rest. T	Set time of restart for power derating in the event of grid over frequency.
Reset country S	Resetting the “grid standard” selection time.

**New PW** - Used to change the password for accessing the SETTINGS menu. The default password is 0000 and can be changed using the display keyboard.

- Use ENTER to scroll the digits (from left to right)
- Use ESC to return to the previous digit (from right to left)
- Press ESC several times to return to the previous menus
- Use DOWN to progressively scroll the numerical scale downwards (from 9 to 0)

Be careful to memorize the new password. For security purposes there is no reset function. If the password is misplaced it will not be possible to access the inverter.

**Cash** - Used to set the name of the currency and the value given to 1 kWh of energy produced. The correct setting of these parameters displays the actual earning/saving given by the system.

- Name: the chosen value is set (default is \$, USD).
- Val/KWh: indicates the cost/incentive of 1 kWh expressed in the chosen currency (default is 0.16).

**Time** – Used to set the current date and time (daylight saving time not included).

**Language** – Used to set the menu language.

**Vstart** – Used to set the Vstart voltage (separately for both channels if they are configured in independent mode). Change the activation voltage only if necessary. A configuration program that can help to correctly size the photovoltaic system is available on the website.

**Alarm** - This section of the menu allows programming of the alarm relay function (available as a normally open contact – N/O, and also as a normally closed contact – N/C). This contact can be used, for example, to activate a siren or a visual alarm, control the disconnect device of an external transformer, or control an external device. Maximum ratings of the alarm contact: 240Vac/1A and 30Vdc/0.8A.

The switching of the relay can be set in four different modes:

- PRODUCTION: the relay switches when the inverter connects to the grid.
- ALARM: the relay switches when there is an alarm (code E).
- ALARM (configurable): the relay switches if there are alarms (code E) or warnings (code W) chosen by the user from a list (Note - the list may show choices that are not available for the specific model).
- CREPUSCULAR: the relay switches only when the input voltage exceeds the input voltage set for connection to the grid.

The operating modes are described in further detail below:

**Production:** the relay switches when a connection to (or disconnection from) the grid occurs. When N/O (or N/C) contact is chosen, it will stay open (or closed) until the inverter is connected to the grid. Once the inverter starts to export power, the relay changes state and closes (or opens).

When the inverter disconnects from the grid, the relay contact returns to its position of rest, open (or closed).

**Alarm:** the relay switches when there is an alarm (Error) on the inverter. No switching occurs when there is a Warning. When N/O (or N/C) contact is chosen, it will stay open (or closed) until the inverter reports an error; once an error is reported, the relay switches state and closes (or opens). The contact remains switched from its rest condition until normal operation is restored.

**Alarm (configurable):** the relay switches when there is an alarm (Error or Warning), which has been selected by the user through the programming menu. If N/O (or N/C) contact is chosen, it will stay open (or closed) until the inverter reports an error or a warning out of those selected from the menu. At that point the relay switches state and closes (or opens) the contact. The relay remains switched from its rest condition until the alarm or warning has disappeared.



**Crepuscular:** (like twilight, dim) the relay usually switches when the voltage from the PV array exceeds/falls below the threshold set for grid connection. If N/O (or N/C) contact is chosen, it will stay open (or closed) until the inverter has an input voltage higher than the one selected for grid connection. The contact remains switched from its rest condition for as long as the inverter is switched ON (even if it is not connected to the grid).

**Remote ON/OFF** - Selecting this function accesses the remote ON/OFF function used to disable the inverter operation by an external switch or an external controller. Set as follows:

- **Disable:** disables the ON/OFF function, so that inverter operation will operate normally, depending only on grid access and external solar radiation, (default).
- **Enable:** Activates the ON/OFF function, requiring an external contact closure to activate the inverter.

Hardware access to the ON/OFF function is via terminals +R and -R, described in section 3. When the function is active:

- Turn OFF the inverter terminals by shorting terminals +R and -R.
- Turn ON the inverter by removing the short between terminals +R and -R.
- With the function enabled, the ON/OFF input status is indicated on the inverter display; when set to OFF, the display will cycle through two screens, *Remote OFF* and *Waiting Rem. ON to restart*.

**Sleep Mode** - This functionality turns OFF the inverter completely and the power absorption is reduced to a minimum (0.6W). In this mode, the inverter allows display of the information available even in the absence of input voltage and therefore in the absence of sufficient sunlight of the PV panels.

The display can be “awakened” by pressing any button on the display with the exception of the ESC button. After 30 seconds of inactivity the display will once again switch OFF automatically.

- Enable (DEFAULT)
- Disable

**UV Prot. T** - This section of the menu allows programming of a time interval for which the inverter stays connected to the grid in a situation where the input voltage has dropped below the undervoltage limit (set at 70% of Vstart).

The default time is set at 60 sec. The user can set it from 1 to 3600 sec. Example: with the UV Prot.time set at 60 seconds, if the VIN drops below 70% of Vstart at 9:00, the inverter stays connected to the grid (taking power from it) until 9:01.

**MPPT** - This section of the menu allows setting the parameters of the maximum power point tracking (MPPT) function. This function is useful when there are shaded areas on the PV array that can create several maximum power points in the work curve.

- MPPT amplitude: the amplitude of the interference introduced in DC is chosen through the setting of this parameter to establish the optimal working point. There are three settings to choose from (LOW, MEDIUM, and HIGH). The default setting is MEDIUM.
- Multi-max scan: by setting this parameter, the user can enable/disable the scan, decide the frequency with which the scan is carried out, and override it manually.
  - a. Enable/Disable: Enables/Disables the scan for identifying the maximum power point of the system.
  - b. Scan Interval: this allows setting the interval of time between scans. The shorter the interval between scans, the greater will be the loss of production due to the fact that, during the scan, energy is transferred to the grid but not at the maximum power point. Each scan takes 2 seconds.

**Power Reduction** – This section of the menu may be used to adjust the limits on active power which the inverter can input to the grid by setting the percentage of rated power at which the limit should be tripped. It can be set from 0% to 100% in 1% steps.



## Information Menu

The INFO menu provides information about the inverter and access to modify the country standard for grid connection.

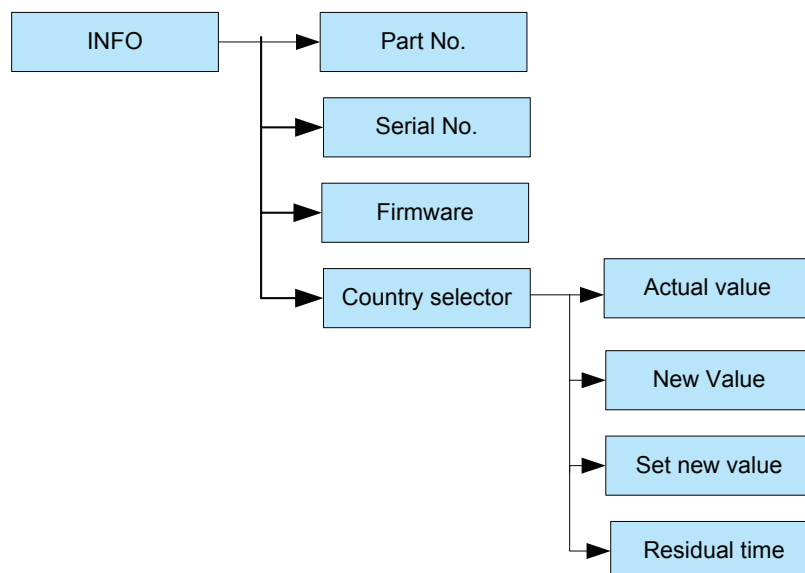

**Part No.** - Displays the UNO part number.

**Serial No.** - Displays the UNO serial number, the week (from 1 to 52) and year of manufacture.

**Firmware** - Displays the revision of the firmware installed in the equipment.

**Country selector** - Displays information regarding the grid standard set with the rotary selectors.

- *Actual value*: Displays the set grid standard.
- *New value*: If the position of the rotary switches is changed (a new grid standard is therefore selected) during operation, the new standard selected will be displayed but will be made effective only after the equipment has been switched off and then on again and only if the time remaining for carrying out this operation has not expired (24 hours of operation).
- *Set new value*: Allows confirm/set of the new grid standard set in the “New value” section of the previous menu. When this function is used, there will be no correspondence between the standard selected on the display and the position of the rotary selectors.
- *Residual time*: Displays the time remaining in which it is still possible to set a new grid standard. When the time expires, *Locked* will be displayed, which indicates it is not possible to change the grid standard again. Call customer service if it is necessary to change the grid standard after the 24 hour period

## Commissioning



**WARNING!** Do not place any items on the inverter during operation.

Do not touch the heat sink when the inverter is operating, as some parts may be hot and cause burns.

### Power ON the inverter

1. Turn the DC disconnect switch in the ON position. If there are two separate external disconnect switches (one for DC and the other for AC), first close the AC disconnect switch and then the DC disconnect switch.

2. Once the inverter is powered, icon **b14** comes on to indicate that the voltage from the photovoltaic array has reached the  $V_{start}$  threshold (voltage necessary for connecting the inverter to the grid).

For input voltages lower than  $V_{start}$ , the icon **b14** remains off, the *Waiting Sun* message is shown on the display and the voltage and current values are present (icons **b15** and **b16**).

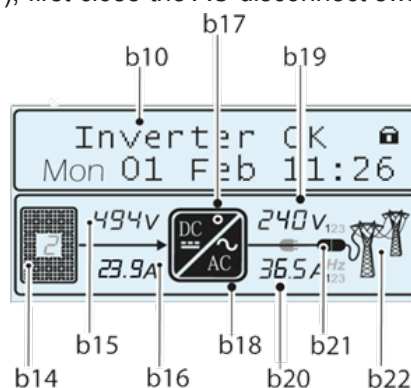

4. If there are no irregularities after checking the grid voltage and frequency parameters, the grid connection sequence starts. Once all the checks are finished, and all grid parameters are observed, icon **b22** comes on. During these checks, icon **b22** is flashing. This check can take several minutes depending on grid conditions and grid standard settings.

5. At this point icon **b17** flashes to indicate the start-up phase. This icon will remain permanently switched ON when the DC-DC is operating at steady state.



At the same time as icon **b17** comes on (steady), icon **b18** will come on to indicate that the inverter circuit has begun working (DC-AC).

6. The grid connection will start immediately. During this phase the icon **b21** will be displayed in steps until the connection of the inverter is complete. After the inverter is connected, the icon **b21** will stay plugged in as shown below.



*Icon b21 – inverter connected to network  
(plugged in)*



*Icon b21 - inverter not connected to network  
(unplugged)*



Once the connection sequence is complete, the inverter starts to operate and indicates correct operation by the green LED lighting steady on the LED panel. This means there is sufficient sunlight to feed power into the grid.

If there is not sufficient sunlight, the unit will repeat the procedure until all the parameters controlling connection to the grid (grid voltage and frequency, confirmation of no ground fault) are within the range. During this procedure, the green LED flashes ON and OFF.

## Dynamic behavior of the display during operation

If the MPPT scan function is enabled, icon **b9** will be shown on the display and flash during scanning.



During operation, the following values are displayed in rotation:

1. Voltage **b15** and current **b16** from the PV field.



Depending on the configuration or model of the inverter, the voltages and currents of one or both channels (or of the single strings) will be displayed.

The input channel measured is indicated by the value displayed in **b14**.

2. Voltage **b19** and current **b20** of the AC grid.

Depending on the model of inverter, the voltages and currents of 1 or 3 phases will be displayed. The phase measured is shown on the right side of the voltage and current values.

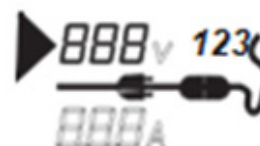

At the end of the display cycle described above, the grid frequency will be indicated in **b20** and the line voltage will be indicated in **b19**. At the same time, the main readings made by the inverter will be displayed in rotation on the two-line graphic display **b10**.

## Power graph

Power graph **b11** is a histogram that includes 16 horizontal units and 20 vertical units. The period of time is represented by the horizontal axis of the graph and can be set by the user to 8, 16 or 24 hours; each horizontal unit can represent 30, 60 or 120 minutes.

The vertical axis represents the maximum power reduction (2.2kW for the UNO-2.0-I-OUTD and 2.75kW for the UNO-2.5-I-OUTD). 100% corresponds to the outgoing exported power value.

The power value expressed by each column of the graph represents the average value of the power during the period relating to the time unit.

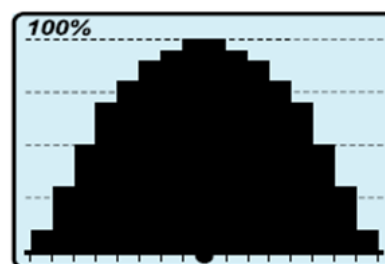





### Obtaining the service level password

An advanced password can be provided to authorized installers to allow access to the service menu upon completion of required documentation. Contact customer service at 877-261-1374 to request this password. The password obtained is valid for a period of 15 days.



**NOTE:** Because the service level password is date sensitive, it is necessary to have the correct date and time set on the inverter display to successfully use the password. Use the *Settings* menu described in section 4 to set the date and time.

The password to access the *Service* menu is based on data associated with a specific serial number and is different for every inverter.

Locate the following information, which is necessary to generate the password, from the product label of the inverter as shown at left.

- Serial number - SN
- Week of manufacture -WK

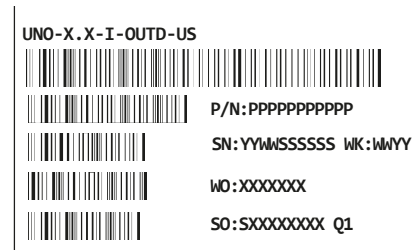

The data can also be found on the *INFO* menu on the inverter display.

### Display messages and error codes

The inverter indicates errors/warnings on the display only if the input voltage is higher than the  $V_{dmin}$  voltage (POWER LED flashing or on; see operations section 4). Next to each state of the inverter, (indicated through the steady or intermittent lighting of the relevant LED), a message that identifies the operation it is carrying out or the detected fault/anomaly, is also indicated in the two-line display. Messages identify the current status of the inverter and do not relate to a fault.

When a (W) with a number after it appears in the display, it indicates a Warning that is usually cleared through an orderly shutdown/re-set or a self-corrective action performed by the inverter. Alarms or (E) codes identify a possible equipment failure, fault, or incorrect inverter setting or configuration. Some of the (E) codes may require technical support to assist in correcting a fault. Any and all attempts to correct or clear a fault must be performed by qualified personnel. Typically, the (E) code can be cleared once the cause or fault is removed. Some of the (E) codes may indicate a fatal error and require technical support for diagnostics and/or a product replacement.

When the red LED comes ON, try to reset the warning using the multi-function ESC button on the panel. If the inverter reconnects to the grid, the fault was due to temporary phenomena.



**WARNING!** In the event of malfunction, it is extremely dangerous to try to eliminate the fault. Follow the instructions given below or contact a specialized technician if you do not have the experience and necessary qualifications to work safely!

Display Message	Causes	Solution
Ground Fault Red LED	The alarm is generated when ground leakage current is detected in the DC section of the system. The alarm is accompanied by the lighting up of the red LED on the front of the inverter.	If possible, measure the insulation resistance using a megohmmeter positioned between the photovoltaic field (positive terminal short-circuited to the negative pole) and ground. If the measured value is less than 1 megohm, the photovoltaic array must be checked by a technician/ installer to identify and eliminate the problem. If the measured value is greater than 1 megohm and the error warning continues to be present, contact customer service.
<b>E001</b> Input OC  Input Overcurrent	The alarm appears when the inverter input current exceeds the set overcurrent threshold.	Check whether the composition of the PV array allows an input current that exceeds the maximum threshold allowed by the inverter and that the configuration of the (independent or parallel) inputs is carried out correctly. If the configuration of the PV array and the setting of the input channels are suitable, contact customer service.
<b>E002</b> Input OV  Input Overvoltage	This alarm is indicated when the inverter input voltage (coming from the PV array) exceeds the operating threshold. The alarm is triggered before reaching the absolute threshold beyond which the inverter will be damaged. When the inverter input voltage exceeds the Over Voltage threshold, the inverter will generate the alarm and not start.	Measure the input voltage in the inverter with a voltmeter. If it is higher than the maximum voltage of the operating interval, the alarm is real. Check the configuration of the PV array. If it is lower than the maximum voltage of the operating interval, the alarm is caused by an internal malfunction; contact customer service.
<b>E003</b> No Parameters  Internal Parameters Error	The main microcontroller is unable to correctly initialize the two DSPs (boost stage and inverter stage). This is usually due to communication problems on the internal bus of the inverter.	This is an error inside the inverter that cannot be checked externally. If the problem persists (after switching the inverter off and then on again), contact customer service.

Display Message	Causes	Solution
<b>E004</b> Bulk OV  Bulk Overvoltage	Error inside the inverter. The alarm is raised when the voltage at the ends of the bulk capacitors exceeds the Over Voltage threshold.	The alarm can be triggered by causes external to the inverter: an excessive inverter input voltage can be detected as a bulk overvoltage condition. In this case, it is advisable to check the inverter input voltage and, if this value is near the input OV threshold, re-examine the configuration of the photovoltaic array. The alarm can be triggered by causes internal to the inverter; If input voltage is O.K. and alarm is still present contact customer service.
<b>E005</b> Comm.Error Internal Communication Error	The alarm occurs when there are communication problems between the control devices inside the inverter.	Error inside the inverter that cannot be checked externally. If the problem persists (after switching the inverter off and then on again), contact customer service.
<b>E006</b> Output OC  Output Overcurrent	The alarm appears when the inverter output current exceeds the output overcurrent threshold of the inverter.	Error inside the inverter that cannot be checked externally. If the problem persists (after switching the inverter off and then on again), contact customer service.
<b>E007</b> IGBT Sat IGBT Saturation	The alarm appears when one of the active devices of the inverter is in saturation state.	Once the error appears, the inverter attempts to resume normal operation. If the error occurs sporadically, it may be caused by a sharp transition of the grid voltage or the input voltage but is not attributable to inverter malfunctioning. If the error is associated with an internal fault, it will continue to appear; contact customer service.
<b>E009</b> Internal error	Error inside the inverter	Error inside the inverter that cannot be checked externally. If the problem persists (after switching the inverter off and then on again), contact customer service.
<b>E010</b> Bulk Low Low Bulk Voltage	Voltage at a specific part of inverter input circuit is not sufficient for grid connection.  The alarm can be triggered by causes external to the inverter: a low inverter input voltage (just above the activation voltage) that is not accompanied by sufficient availability of power from the photovoltaic array (typical condition of periods of insufficient sunlight).	If the error warning appears sporadically, it can be attributed to causes external to the inverter (insufficient sunlight, and therefore little power available from the PV array).  If the problem appears systematically even in conditions of high sunlight and with input voltage significantly higher than the activation voltage, contact customer service.



Display Message	Causes	Solution
<b>E011</b> Ramp Fail Bulk ramp timeout	Error inside the inverter regarding the time for starting steady state operation of the DC-DC circuit part (Boost). It can be caused by an external string voltage too low or due to reduced power from PV arrays (typically in the morning).	If the alarm is present early in the morning it could be useful to increase the starting voltage to allow the grid connection of the inverter when more power is available from the PV array. If the problem persists (after switching the inverter off and then on again), contact customer service.
<b>E012</b> DcDc Fail Boost module error	Error inside the inverter regarding the operation of the DC-DC circuit part (Boost).	Error inside the inverter that cannot be checked externally. If the problem persists (after switching the inverter off and then on again), contact customer service.
<b>E013</b> Wrong Mode Wrong Input Mode (parallel instead of independent)	The alarm is generated only when the inverter is configured with parallel inputs. In this particular configuration, the inverter carries out the input voltage check of each of the two channels, and the alarm is raised if the two voltages differ by more than 20Vdc.	Make sure the setting of the "IN MODE" switch has been intentionally positioned on "PAR" and that the jumpers have been inserted between the two input channels. If the configuration of the inverter is correct, check that the input strings have the same number of panels in series, of the same make and with the same inclination/orientation. If both the configuration of the inverter and the characteristics of the PV array comply with the specifications, contact customer service.
<b>E014</b> Over Temp. Over-temperature	Internal inverter temperature above maximum temperature allowed. Lack of adequate ventilation in location where inverter is installed can be the cause. If ambient temperature is within the allowed range for inverter operation, the error could be due to a problem in the temperature sensors inside the inverter.	Wait for the temperatures to which the inverter is exposed to return within operating range and for the inverter to cool down. If the problem persists (once the ambient temperature has returned within the range), contact customer service. Remember to wait for the time necessary to allow the inverter to cool down.
<b>E015</b> Bulk Cap Fail  Bulk capacitor failure	Error inside the inverter regarding a problem in the bulk capacitors.	Error inside the inverter that cannot be checked externally. If the problem persists (after switching the inverter off and then on again), contact customer service.
<b>E016</b> Inverter Fail  Inverter module error revealed by Boost	The alarm is generated when a problem is detected in the inverter circuit part (DC/AC).	Error inside the inverter that cannot be checked externally. If the problem persists (after switching the inverter off and then on again), contact customer service.



Display Message	Causes	Solution
<b>E017</b> Start Timeout Inverter module start-up timeout	Error inside the inverter regarding the time for starting steady state operation of the DC-AC circuit part (Inverter). It can be caused by an external string voltage too low or due to reduced power from PV arrays (typically in the morning).	If the alarm is present early in the morning it could be useful to increase the starting voltage to allow the grid connection of the inverter when more power is available from the PV array. Error inside the inverter that cannot be checked externally. If the problem persists (after switching the inverter off and then on again), contact customer service.
<b>E018</b> Ground Fault Leakage current fail	The alarm is generated when, during normal operation of the inverter, a ground leakage current is detected in the DC section of the system. The alarm is accompanied by the lighting up of the red LED on the front of the inverter. The inverter may even also generate the E018 alarm message for AC leakage currents associated with the capacitive nature of the photovoltaic array compared to ground.	If possible, measure the insulation resistance using a megohmmeter positioned between the photovoltaic field (positive terminal short-circuited to the negative pole) and ground. If the measured value is less than 1 megohm, the PV array must be checked by a technician/installer to identify and eliminate the problem. If the measured value is greater than 1 megohm and the error warning continues to be present, contact customer service.
<b>E019</b> Self-Test Error 3 Leakage current sensor self- test fail	Before connecting to the grid, the inverter carries out an autotest that tests the leakage current sensor. The test is carried out by "forcing" a current of known value in the leakage current sensor: the microprocessor compares the read value with the known value. The error is generated if the comparison between the read value and the known value during the test is not within the allowed tolerance.	This is an error inside the inverter that cannot be checked externally. If the problem persists (after switching the inverter off and then on again), contact customer service. By its nature, the alarm appears only before connection to the grid.
<b>E020</b> Self-Test Error 1 Booster relay self- test fail	Before connecting to the grid, the inverter carries out some internal tests. One of these tests regards the correct operation of the boost relay. The test is carried out by "forcing" the switching of the relay and checking its functionality. The error is generated if a problem is found with the operation of the relay.	This is an error inside the inverter that cannot be checked externally. If the problem persists (after switching the inverter off and then on again), contact customer service. By its nature, the alarm appears only before connection to the grid.



Display Message	Causes	Solution
<b>E021</b> Self-Test Error 2  Inverter relay self-test fail	Before connecting to the grid, the inverter carries out a test that regards the operation of the inverter relay. The test is carried out by “forcing” the switching of the relay and checking its functionality. The error is generated if a problem is found with the operation of the relay.	This is an error inside the inverter that cannot be checked externally. If the problem persists (after switching the inverter off and then on again), contact customer service. By its nature, the alarm appears only before connection to the grid.
<b>E022</b> Self-Test Error 4 Relay self- test timeout	Time taken to execute the autotest carried out on the relays of the DC_ AC circuit part (inverter) is too long. This may indicate a problem associated with the aforesaid relays.	Error inside the inverter that cannot be checked externally. If the problem persists (after switching the inverter off and then on again), contact customer service.
<b>E023</b> DC inj error Dc-Injection out of range	The error is generated if the direct component of the current supplied to the grid exceeds the threshold of 0.5% of the rated operating current. The error does not stop the inverter, instead tries to connect to the grid again. Sporadic repetition of the error is a sign of large grid distortions or sudden changes in sunlight, whereas systematic repetition of the error warning will be a sign of an inverter fault.	If the grid voltage is strongly distorted, report this anomaly to the utility company for the resolution of the problem. If there is an inverter fault, contact customer service.
<b>E024</b> Internal error	Error inside the inverter	Error inside the inverter that cannot be checked externally. If the problem persists (after switching the inverter off and then on again), contact customer service.





Display Message	Causes	Solution
<b>E025</b> Riso Low Low insulation resistance	<p>Before connecting to the grid, the inverter measures the insulation resistance of the PV array compared to ground. If the insulation resistance measured by the inverter is less than 1 MOhm, the inverter does not connect to the grid and shows the “Riso Low” error. The causes may be:</p> <ul style="list-style-type: none"> <li>- Damaged PV panel(s).</li> <li>- Junction box(es) not properly sealed, allowing water and /or damp seepage ;</li> <li>- Loose connections between panels allowing humidity leakage;</li> <li>- Poor quality cable junctions;</li> <li>- Presence of unsuitable (trigger voltage lower than the characteristics of the PV array strings) or damaged overvoltage surge arresters outside the inverter in the DC section.</li> <li>- Presence of damp inside the field panel, if there is one.</li> </ul>	<p>If possible, measure the insulation resistance using a megohmmeter positioned between the photovoltaic field (positive terminal short-circuited to the negative pole) and ground (as described in the relevant section: “checking the ground insulation of the PV array”). If the measured value is less than 1 mega ohm, the photovoltaic array must be checked by a technician/installer to identify and eliminate the problem. If the measured value is greater than 1 mega ohm and the error warning continues to be present, contact customer service.</p> <p>(Damp increases leakage and can therefore be the cause of a reduction in insulation resistance).</p>
<b>E026</b> Vref Error Bad internal reference voltage	Wrong measurement of the reference voltage inside the equipment.	Internal error that cannot be checked externally. If the problem persists (even after switching the inverter off and then on again), contact customer service.
<b>E027</b> Error Meas V VGrid Measures Fault	Error in the internal measurement of the grid voltage (imposed by regulations) to have a measurement redundancy (2 measurements on the same parameter carried out by two different circuits).	This is an error inside the inverter that cannot be checked externally. If the problem is persistent (even after switching the inverter off and then on again), contact customer service.
<b>E028</b> Error Meas F FGrid Measures Fault	Error in the internal measurement of the grid frequency (imposed by regulations) to have a measurement redundancy (2 measurements on the same parameter carried out by two different circuits).	This is an error inside the inverter that cannot be checked externally. If the problem is persistent (even after switching the inverter off and then on again), contact customer service.
<b>E029</b> Error Meas Z ZGrid Measures Fault	Error in the internal measurement of the insulation resistance of the PV array compared to ground (imposed by regulations) to have a measurement redundancy (2 measurements on the same parameter carried out by two different circuits).	Error inside the inverter that cannot be checked externally. The error occurs if the internal measurement is carried out before connection to the grid) If the problem is persistent (even after switching the inverter off and then on again), contact customer service.

Display Message	Causes	Solution
<b>E030</b> Error Meas ILeak ILeak Measures Fault	Error in the internal measurement (carried out when the inverter is connected to the grid) of the leakage current of the DC side (PV array) compared to ground (imposed by regulations) to have a measurement redundancy (2 measurements on the same parameter carried out by two different circuits).	This is an error inside the inverter that cannot be checked externally. If the problem is persistent (even after switching the inverter off and then on again), contact customer service.
<b>E031</b> Error Read V Wrong V Measure	Measurement of the internal voltage at the ends of the output relay out of range. There is too great a difference in voltage between the input and the output of the output relay that can be caused by grid voltage instability.	Check the grid conditions for instabilities caused by switch of heavy loads or reactive loads (like motors, welding machines etc.). If the problem appears repeatedly, contact customer service.
<b>E032</b> Error Read I Wrong I Measure	Measurement of the output voltage unbalance (carried out between the three phases) out of range (only in three-phase models).	This is an error inside the inverter that cannot be checked externally. If the problem appears repeatedly contact customer service.
<b>E033</b> UTH Under Temperature	Alarm is triggered when internal temperature is below low temperature threshold. Depending where the inverter is located, ambient temperature can reach values below UT limits. In case in which ambient temperature is above that UTH limits, a failure of the temp sensing circuitry is occurred.	Wait for the temperatures to which the inverter is exposed to return within operating range. If the problem persists, contact customer service. Remember to wait for the time necessary to allow the inverter to warm up.
<b>E034</b> Interlock fail IGBT not ready	Error inside the inverter	Error inside the inverter that cannot be checked externally. If the problem persists (after switching the inverter off and then on again), contact customer service.
<b>E035</b> Remote Off Waiting remote ON	The inverter has been switched off remotely (remote OFF) and remains in waiting state for the signal that will switch it on again (remote ON).	Switch on the inverter remotely. If the unit does not switch on, disable the remote on/off function and switch the equipment off completely and then switch it on again. If the problem persists (after re-enabling the Remote ON/ OFF function from the display), contact customer service.





Display Message	Causes	Solution
<b>E036</b> Vout Avg error  Average Vout out of range	The average grid voltage value (every 10 minutes) does not fall within the allowed ranges. The grid voltage at the point connected to the inverter is too high. This may be caused by grid impedance that is too high. Towards the end of the timeout, the inverter limits the power to check whether the grid voltage stabilizes within the normal parameters. If this does not happen, the inverter disconnects from the grid.	Check the grid voltage at the inverter connection point. If the grid voltage diverges from the range because of grid conditions, ask the grid company to adjust the grid voltage. If the grid company authorizes a change to the inverter parameters, arrange the new limits with customer service.
<b>E037</b> Riso Low  Low insulation resistance (amorphous mode only)	This error can appear only if the "Amorphous" mode is enabled. This function is enabled only in inverters equipped with grounding kit and is used to monitor the voltage at the ends of the grounding resistor. The error appears when the voltage at the ends of the resistor connected between ground and pole of the photovoltaic array exceeds 30V for more than 30 minutes or 120V for more than one second.	Check for the presence and correct contacting of the two terminals of the grounding resistor installed inside the inverter. If possible, measure the insulation resistance using a megohmmeter positioned between the PV field (positive terminal short-circuited to the negative pole) and ground (as described in the operation chapter). If the measured value is less than 1 mega ohm, the photovoltaic array must be checked by a technician/ installer to identify and eliminate the problem. If the measured value is greater than 1 mega ohm and the error warning continues to be present, contact customer service.
Mid Bulk OV <b>E038</b> Mid bulk OV	NA	NA
<b>E050</b> Arc Fault (-A version ONLY) DC Arc detected	An electrical arc has been detected on DC cables. This error latches the inverter in a disconnected state	Check DC cables and connections to identify the source of possible arcing. Press ESC as indicated in the display in order to unlatch the inverter.
<b>E053</b> AF Self-Test (-A version ONLY) Arc fault detector (AFD) sensor Self-test failed	Self-Test performed by AFD board failed. The board will try another self-test after user turns inverter off and on.	Press ESC as indicated in the display in order to unlatch the inverter. If the problem persists (after switching the inverter off and on), contact customer service.



Display Message	Causes	Solution
<b>E056</b> Over Temp. (from external box)	Excessive temperature measured inside the inverter's wiring box: High internal temperature. This error relates to the temperature measured on external boxes.	Check that the inverter is not exposed to direct sunlight. Wait for the temperatures to which the inverter is exposed to return to the operating range and for the inverter to cool down. If the problem persists (once the ambient temperature has returned to the range), contact customer service.
<b>E057</b> Vbulk reading error	Input voltage ( $V_{in}$ ) higher than booster voltage ( $V_{bulk}$ ): The error occurs if the input voltage exceeds the Bulk voltage (voltage on the DC-DC circuit inside the inverter)	Measure the input voltage inside the inverter with a voltmeter. If it is higher than the maximum voltage of the operating range, it is necessary to check the configuration of the PV array. If the voltage has also exceeded the maximum input threshold the inverter could be damaged. If it is lower than the maximum voltage of the operating range, the alarm is caused by an internal malfunction and it is necessary to contact customer service.
<b>E058</b> Pin vs. Pout check error	The error occurs if the difference between the measured value of input power and that of output power is greater than the limit imposed internally to the inverter.	Error inside the inverter that cannot be checked externally. If the problem persists (after switching the inverter off and then on again), contact customer service.
<b>W001</b> Sun Low (Low input voltage during switch-on of the inverters)	Insufficient sunlight. Wrong configuration of the PV array or a configuration "at the limit" as regards the minimum input voltage of the inverter.	Check the inverter input voltage. If it does not exceed the $V_{start}$ , check that there is sufficient sunlight and that the composition of the system is correct. If it exceeds the $V_{start}$ , contact customer service.
<b>W002</b> Input UV (Low input voltage during switch-off)	Insufficient sunlight Wrong configuration of the photovoltaic array or a configuration "at the limit" as regards the minimum input voltage of the inverter.	Check the inverter input voltage. If it does not exceed the $V_{start}$ , check that there is sufficient sunlight and that the composition of the system is correct. If it exceeds the $V_{start}$ , contact customer service.



Display Message	Causes	Solution
<b>W003</b> Grid Fail  Grid Fail (grid voltage parameters outside the limits)	This error warning appears during normal operation of the inverter when the grid parameters fall outside the limits set by the grid company. No grid voltage (after the warning, the inverter goes on "No Vac") Unstable grid voltage (downwards and upwards) Unstable grid frequency.	Check the grid voltage on the inverter. If absent, check for the absence of grid voltage on the supply. If the voltage tends to rise (when the inverter is connected), it means there are high line or grid impedances. Check the grid voltage on the supply as well; if it is high, it means there is high grid impedance. In this case, ask the grid company to adjust the grid voltage. If the grid company authorizes a change to the inverter parameters, arrange the new limits with the customer service. If the voltage at the supply point is much lower than that measured on the inverter, the line must be adjusted (inverter- counter). If the grid voltage and frequency fall within the limits (even when the inverter is connected to the grid), contact customer service.
<b>W009</b> Table fail	NA	NA
<b>W010</b> Fan Fail (Alarm not shown on the display; there is only a flashing yellow LED)	This error appears when there is malfunctioning of the fan(s) inside the inverter. In this condition, the yellow LED on the front panel flashes.	Error inside the inverter that cannot be resolved with external operations. If the alarm is persistently repeated, contact customer service.
<b>W011</b> Bulk UV	Reading of the internal voltage on the bulk capacitors carried out when the inverter is connected to the grid.	
<b>W012</b> Battery low  Low internal clock battery voltage	Internal battery for maintenance of the date/time settings is discharged or damaged.	Replace the battery with the inverter completely switched off (disconnect AC side and DC side) and be sure to observe the correct polarity.
<b>W013</b> Clk fail  Internal clock failure	The alarm appears when the time shown on the display differs by more than 1 minute from the internal time of the microprocessors and indicates clock circuit malfunctioning.	This is an error inside the inverter that cannot be resolved with external operations. If the alarm is persistently repeated, contact customer service.



Display Message	Causes	Solution
<b>W017</b> Jbox fail  Fuse-control board fail (DC string fail)	Fuse(s) on the fuse boards is/are damaged.	Using a multimeter, check the condition of the fuses (situated on the fuse boards). Replace any open fuses and check that the input current on the string(s) does not exceed the rating of the fuses (if string parallels have been made outside the inverter). If there are no damaged string fuses and the inverter continues to display the alarm message, check whether the settings to be made through the Aurora Manager software are correct (presence or absence of one or more input strings).
<b>W018</b> SPD DC protection open	Overvoltage surge arresters situated on the DC side are damaged.	Look at the inspection window present on each surge arrester (DC side). If it is red, the surge arrester is damaged and the cartridge must be replaced. If the alarm status continues to be present even though all the surge arresters have a green inspection window, contact customer service.
<b>W019</b> SPD AC protection open	Overvoltage surge arresters situated on the AC side are damaged.	Look at the inspection window present on each surge arrester (AC side). If it is red, the surge arrester is damaged and the cartridge must be replaced. If the alarm status continues to be present even though all the surge arresters have a green inspection window, contact customer service.
<b>W022</b> Reactive power mode changed notification only	Variation in the means of managing reactive power; this change is made through the display or advanced configuration software.	Notification of change that is saved in the historical log of inverter events.
<b>W023</b> Date/time changed notification only	Variation of the inverter's date and time; this change is made through the display or advanced configuration software.	Notification of change that is saved in the historical log of inverter events.
<b>W024</b> Energy data reset notification only	Zeroing of the statistical energy data stored in the EEPROM: Reset of the energy data saved in the inverter; this operation can be handled through the display or advanced configuration software.	Notification of change that is saved in the historical log of inverter events.  The notice may also occur on substitution of the Memory Card where the statistical production data is saved.



## Verification of ground leakage

If the inverter has reported a ground fault, there may be a ground leakage from the PV array (DC side). To check this, measure the voltage between the positive pole and ground and between the negative pole (of the PV array) and ground using a voltmeter whose input accepts a voltage of at least 1000 Volts.

### Behavior of a system without leakage

Due to the capacitive effect of the PV array, during the first moments that the voltmeter is connected between one of the two poles and ground, it will measure a voltage of about  $V_{oc}/2$ , which will tend to stabilize to around 0V if there is no ground leakage, as shown in the graph below:

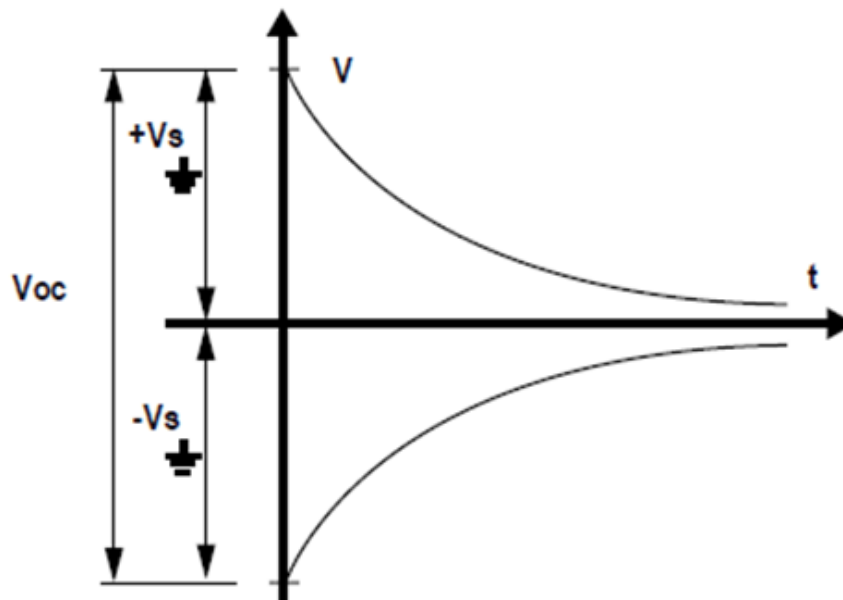

The internal resistance of the voltmeter tends to zero the voltage present on the PV array due to the capacitive effect. Refer to the figure below to make the measurement.

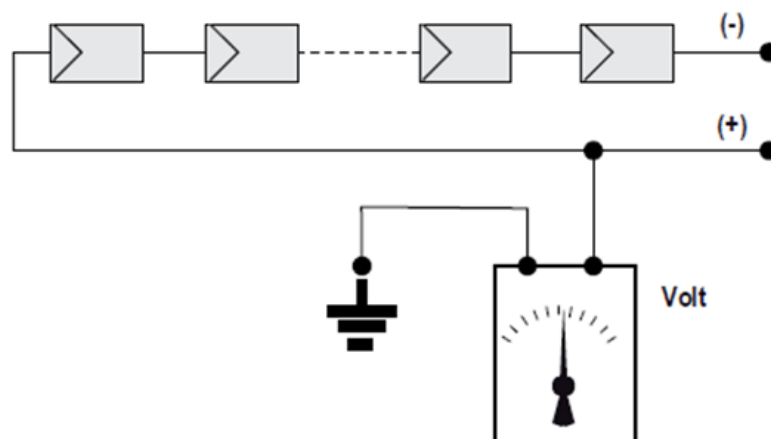

# Behavior of a system with leakage

If the voltage measured between one of the two poles and ground does not tend to 0V and stabilizes on a value, there is a ground leakage from the photovoltaic array.

Example: When the measurement is made between positive pole and ground, a voltage of 200V is measured.

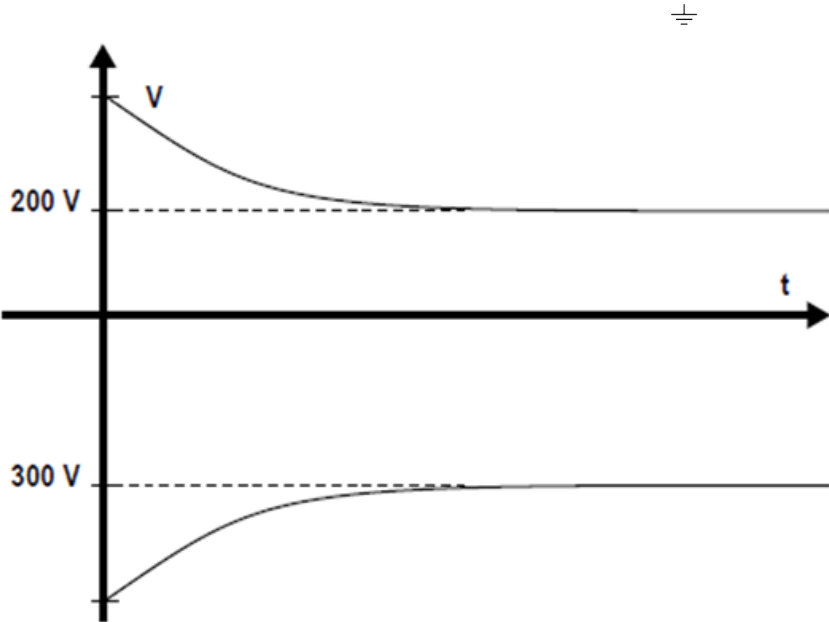

This means that if the system is made up of 10 modules in series and each one supplies 50V, the leakage can be located between the 4th and 5th photovoltaic module.

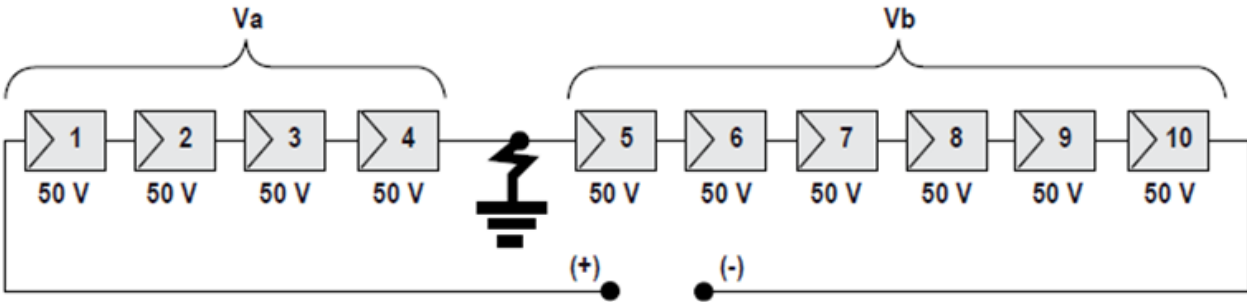

$V_a$  = voltage measured between + pole and = 200V  
 $V_b$  = voltage measured between - pole and = 300V  
 In all the measurements with , the ground of the inverter is indicated.



## Measuring the insulation resistance (RISO)



NOTE! The RISO is affected by the environmental conditions the PV array (e.g. PV modules wet from damp or rain), and therefore the measurement must be made immediately after the inverter gives the RISO LOW warning.

To measure the insulation resistance of the PV array compared to ground ( ), the two poles of the PV array must be shorted (using a suitably sized switch).

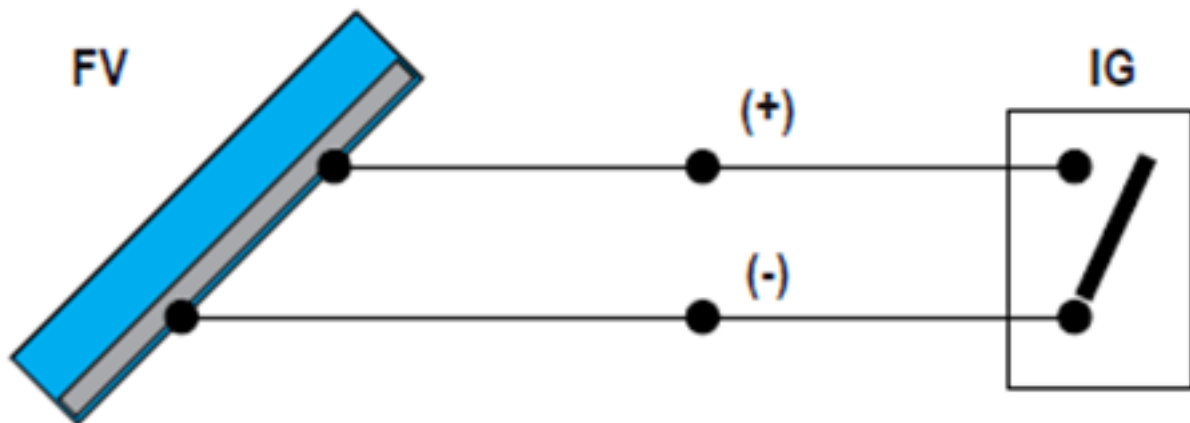

Once the short-circuit has been made, measure the insulation resistance (RISO) using a megohmmeter positioned between the two shorted poles and ground (of the inverter). If the RISO is less than 1 MOhm, the inverter does not connect to the grid because of low insulation of the photovoltaic array to ground, as illustrated below.

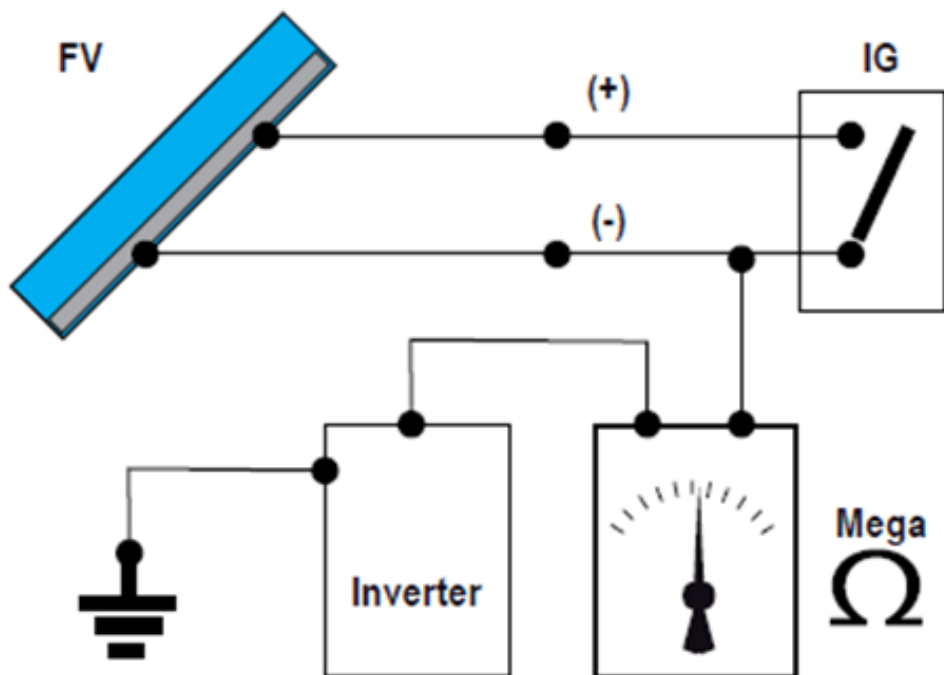

## Making a service call

The following information is necessary to initiate a call with technical support at 877-261-1374. The model number, serial number, and week of production can be found on the INFORMATION menu of the inverter display and also on the product label.

Model number  
Serial number  
Week of production

State of LED:

- Status of light(s)
- Steady or flashing
- Error message or code

### Identify the System structure:

- Information on the Photovoltaic Field
- Brand and model of photovoltaic panels
- Maximum array voltage and current values
- Number of strings in the array
- Number of panels for each string

### Provide a description of the conditions:

- Can the fault be reproduced? If so, how?
- Is the fault cyclical in nature? If so, how often?
- Was the fault apparent at the time of installation? If so, has it worsened?
- Describe the atmospheric conditions at the time the fault appears/appeared.





## Maintenance

# 6



Maintenance operations must be carried out with the equipment disconnected from the grid unless otherwise indicated.

Maintenance operations must be carried out by specialized staff assigned to perform this work. DO NOT allow the equipment to be used if problems of any kind are found.

For cleaning, DO NOT use rags made of filamentary material or corrosive products that may damage parts of the equipment or materials which may generate electrostatic charges. Avoid temporary repairs. All repairs should be carried out using only genuine spare parts. The maintenance technician is under an obligation to promptly report any anomalies.

Always use the personal protective equipment provided by the employer and comply with the safety conditions in Part 1 of this manual. ABB accepts no liability if the periodic checks and maintenance cycles indicated in this manual and in the attached documentation are not complied with correctly, or if maintenance is entrusted to unqualified staff.

## Power-down procedure

Once the inverter is wired and connected to the grid use the following procedures to disconnect for maintenance.



THE FOLLOWING OPERATIONS MUST ALWAYS BE PERFORMED before accessing the power input of the switchbox in order to avoid injury to personnel and/or damage to equipment. After shutdown, wait at least 10 minutes before removing guards or covers in order to allow devices inside the unit to cool and allow any electrostatic charges and parasitic voltages to dissipate.





Disconnect from the AC Grid by one of the following methods:

- Turn-OFF the external AC switch
- Turn-OFF the Over Current Protection Device (circuit breaker)

Disconnect the inverter from the PV array by turning OFF the external DC disconnect switch. **NOTE: When possible, turn off the AC switch first; however, there is no specific order for turning off the two switches.**

## Routine maintenance

Checking and maintenance operations must be carried out by specialized staff assigned to carry out this work. DO NOT allow the equipment to be used if problems of any kind are found, and restore the normal conditions correctly or make sure this is done.

	Clean the equipment at least annually; in particular, the lower grill on the wiring box through which the air for cooling the heatsink passes and the heatsink itself. If possible, use an extractor or suitable pipe cleaners.
	Clean the photovoltaic panels every six months, at the change of season or as necessary. The performance of the system depends on the condition of the PV panels. To clean, follow the specifications of the PV panel supplier.
	Once a year or in the event of malfunction, check that the environmental conditions have not changed drastically (exposure to weather conditions); also check that the inverter or PV panels have not been shaded or isolated by foreign bodies.
	Once a year or in the event of malfunction, check the tightness of the cable openings, the fitting of the connectors, and front covers. Loose fittings can allow water seepage into the cabinet which may result in short circuits due to high humidity.

## Other maintenance

INTERVAL	INVERTER MAINTENANCE ITEM
6 months	Check the cooling air path and heatsink for blockages
Annually	Check internal cooling fan operation (monitor start-up for warning)
Annually	Check DC pressure connectors*
Annually	Check AC pressure connectors*
Annually	Re torque chassis access covers to insure NEMA4X compatibility*
Annually	Check all connections terminals for discoloration or signs of high temp/current*
3 years	Remove and replace the memory back-up battery, see instructions below

\* Check initially after first six months of operation, then annually. In case of malfunctions between maintenance points, recheck all items after repairs are completed.



## CR2032 battery replacement

The CR2032 battery housing **a08** is located on the inverter connection board and is visible after opening the inverter cover. When this battery is at end-of-life, a message is displayed informing that the battery needs to be replaced.

- Insert the new battery into its holder, sliding in at a 30° angle.
- The battery should seat into the correct position within the holder.
- Close the front cover and tighten the cover screws with at least 2.0Nm (17.7 in-lbs) torque to maintain NEMA4X compliance when complete.

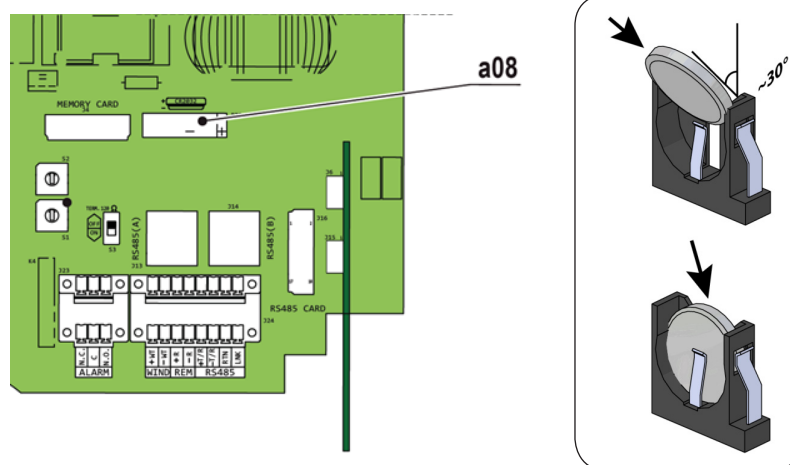

## Storage and dismantling



If the equipment is not used immediately or is stored for long periods, check that it is packaged correctly and contact customer service for storage instructions. The equipment must be stored in well-ventilated indoor areas in a noncorrosive environment. Restarting after a long period requires the removal of oxidation and dust that may have settled inside the equipment if not suitably protected.

ABB CANNOT be held responsible for disposal of the equipment, displays, cables, batteries, etc. The customer must dispose of these substances, which are potentially harmful to the environment, in accordance with the regulations in force in the country of installation.

If the equipment is dismantled, follow the regulations in force in the country of destination and avoid causing any kind of pollution upon disposal. Use dumps suitable for disposal of the various types of materials listed below.

COMPONENT	MATERIAL OF CONSTRUCTION
Frame, brackets, supports	Carbon steel or stainless steel
Casing or covers	Aluminum
Paint	Epoxy based powder coat
Plugs and seals	Rubber / (Neoprene and/or Butadiene) / Polyimide PA6
Electrical cables	Copper / PVC jacket
Cable trays	Polyethylene / Nylon
Backup battery	Nickel / Lithium
Component parts	May contain small amounts of lead; product uses lead free solder.



## System description

UNO grid-tied inverters provide the capability to supply the utility grid with energy obtained from photovoltaic panels. To use the DC generated by a photovoltaic field efficiently, it must be transformed into alternating current (AC) via a conversion process known as DC-AC inversion.

This process is the basis of all grid-tied inverters and is achieved very efficiently by the inverter without the use of rotating elements. When the inverter output is connected in parallel to the utility power grid, the alternating current output from the inverter flows directly into the distribution circuit, and is connected in turn to the public distribution utility grid. The photovoltaic energy system can thus feed all the connected user electrical loads:

- If the energy supply from the photovoltaic system is lower than the user's load requirement, the quantity of energy necessary to guarantee normal functioning of the connected appliances is taken from the public distribution network.
- If the energy supply from the photovoltaic system is greater than the user's load requirement (i.e. an excess of energy is produced) it is sent directly into the public network, becoming available to other users.

Depending on prevailing codes and regulations of the installation area, the energy produced can be sold to the utility or credited against future consumption, producing energy savings.

### **STRINGS AND ARRAYS**

A photovoltaic panel consists of many photovoltaic cells mounted on the same support. A string consists of a certain number of panels connected in series. An array consists of two or more strings connected in parallel. Large photovoltaic systems can be made up of several arrays, connected to one or more inverters. By maximizing the number of panels inserted into each string, the string output voltage is increased, which reduces the cost and complexity of the photovoltaic system. The current of each array must fall within the limits of the inverter.

### **Connection of several inverters together**

If the photovoltaic system exceeds the capacity of a single inverter, it is possible to make a multiple connection of inverters to the system, with each one connected to a suitable section of the photovoltaic field, on the DC side, and connected to the grid on the AC side. Each inverter with multiple strings will work independently of the others and will supply the grid with the maximum power available from its section of photovoltaic panels.

### **Notes on the sizing of the system**

Decisions about how to structure a photovoltaic system depend on a certain number of factors and considerations to make, such as for example, the type of panels, the availability of space, the future location of the system,

energy production goals over the long term, etc. A configuration program that can help to correctly size the photovoltaic system is available on the website.

## Protective devices within the inverter

### **Anti-Islanding**

In accordance with required national standards and laws, in the event of a local grid outage by the utility, or when the grid equipment is switched OFF for maintenance operations, the inverter must be physically and safely disconnected, to ensure protection of personnel working on the grid. To prevent possible islanding, the inverter has an automatic protective disconnection system called “Anti-Islanding”.

### **Ground fault in the photovoltaic panels**

An advanced ground fault protection circuit continuously monitors the ground connection and disconnects the inverter when a ground fault occurs, indicating this condition by means of the red GFI on the LED panel.

### **Further protective devices**

The inverter is equipped with additional protective devices to guarantee safe operation in any circumstance. These protective devices include:

- Continuous monitoring of the grid voltage to ensure the voltage and frequency values stay within operating limits.
- Control of internal temperatures to automatically limit the power if necessary to ensure the unit does not overheat (derating).

## Topographic diagram of the equipment



The block diagram on the following page summarizes the operation of the inverter. The main blocks are the DC-DC input converter (called “booster”) and the DC-AC output inverter. Both work at a high switch-over frequency and are small and relatively light.

This inverter is equipped with a high-frequency transformer with galvanic isolation of the primary (DC side) from the secondary (AC side), while maintaining very high performance in terms of output and energy export. This type of circuit allows for the grounding of the inputs, both positive and negative, where required by the solar panel type used or by the rules of the country of installation.

The inverter is equipped with a single input converter with Maximum Power Point Tracking (MPPT) to which it is possible to connect two strings of photovoltaic panels. Due to the high efficiency and the large heat dissipation system, a maximum power operation is guaranteed in a wide range of the ambient temperatures without the use of external cooling fans. The inverter is controlled by two independent DSPs (Digital Signal Processors) and a central microprocessor.

The connection to the power grid is kept under control by two independent monitors, in full compliance with the electric field norms both for power supply to the systems as well as security. The inverter is already equipped with all the protections necessary for safe operation and compliance with the norms. The operating system performs the operation of communicating with the relevant components to carry out data analysis.

All this guarantees optimal operation of the entire unit and high efficiency in all insulation and load conditions, always in full compliance with the relevant directives, standards and provisions.

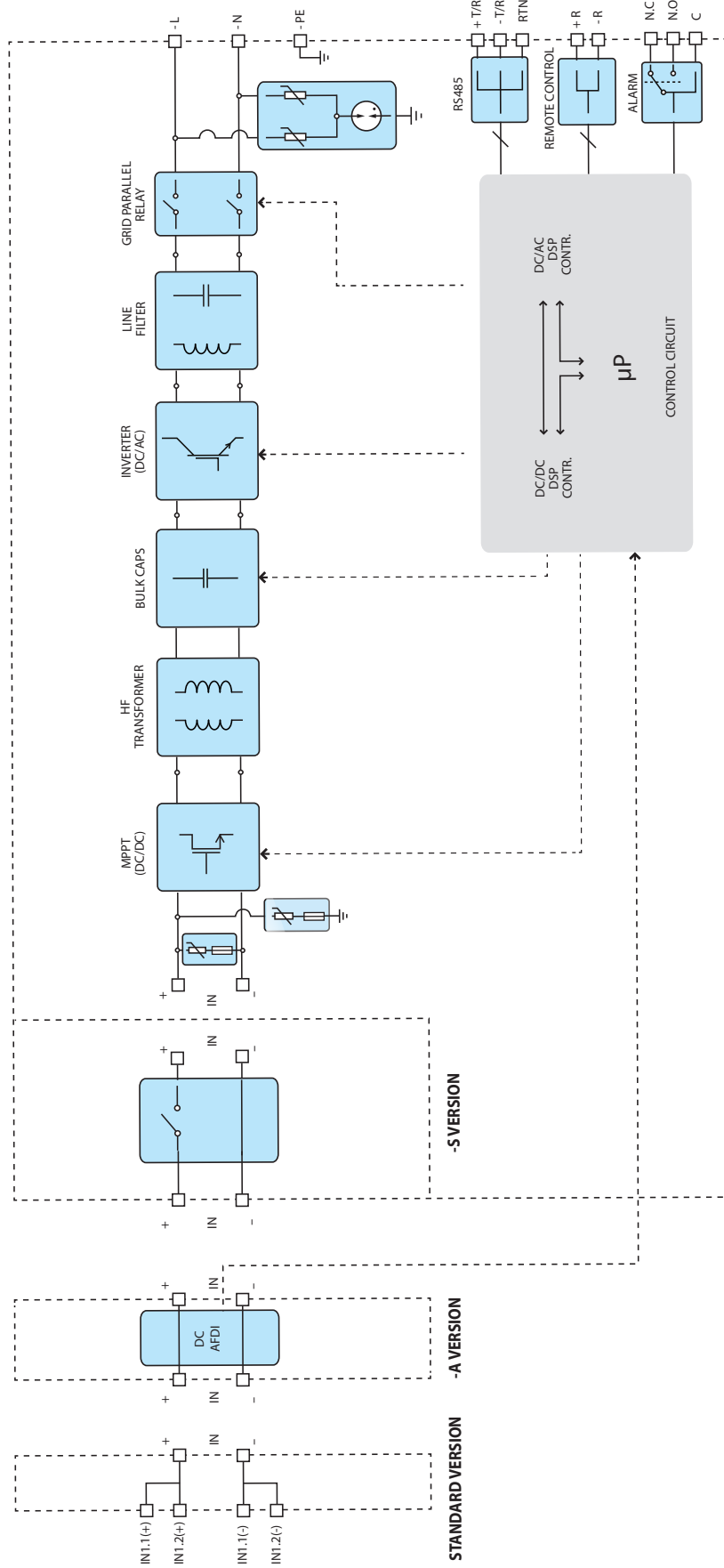

## Efficiency curves

The equipment was designed in compliance with energy conservation standards to avoid waste and unnecessary leakage. Graphs of the efficiency curves of the inverters are shown below. The efficiency curves are affected by technical parameters that are continually being developed and improved and should be considered approximate.

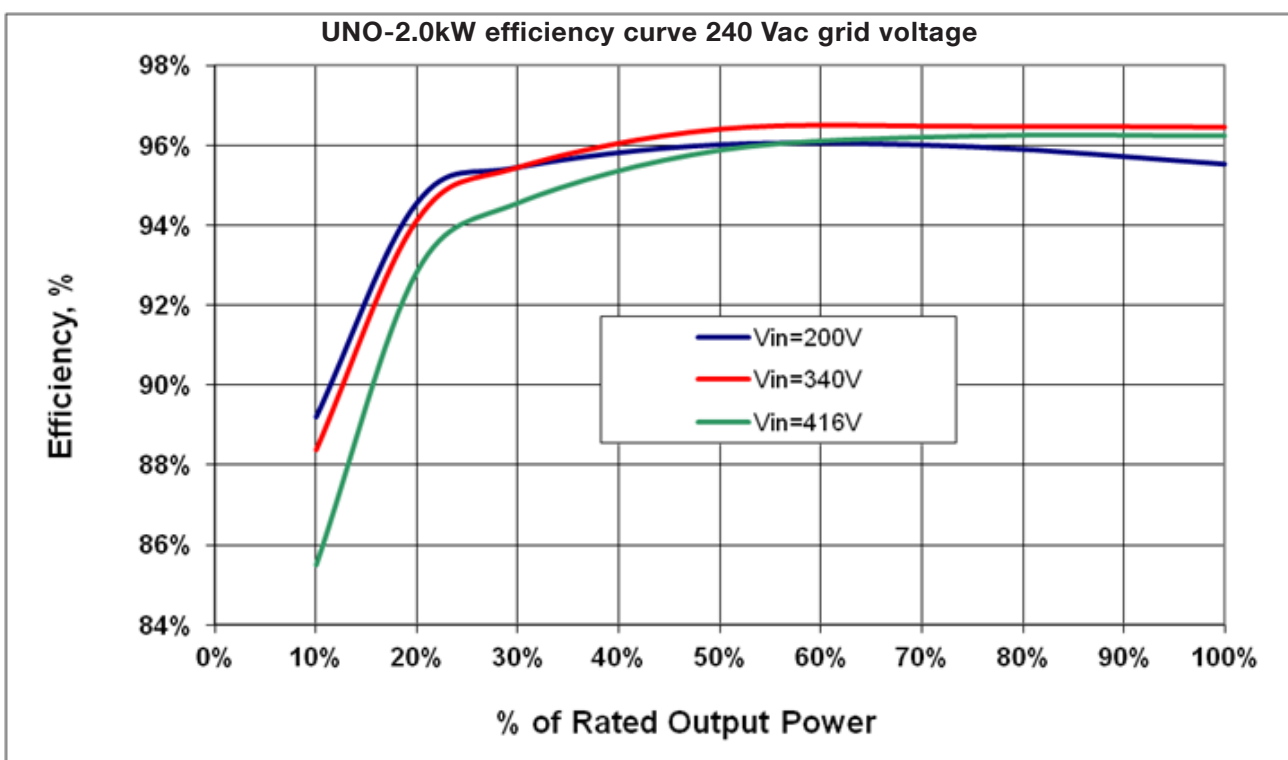
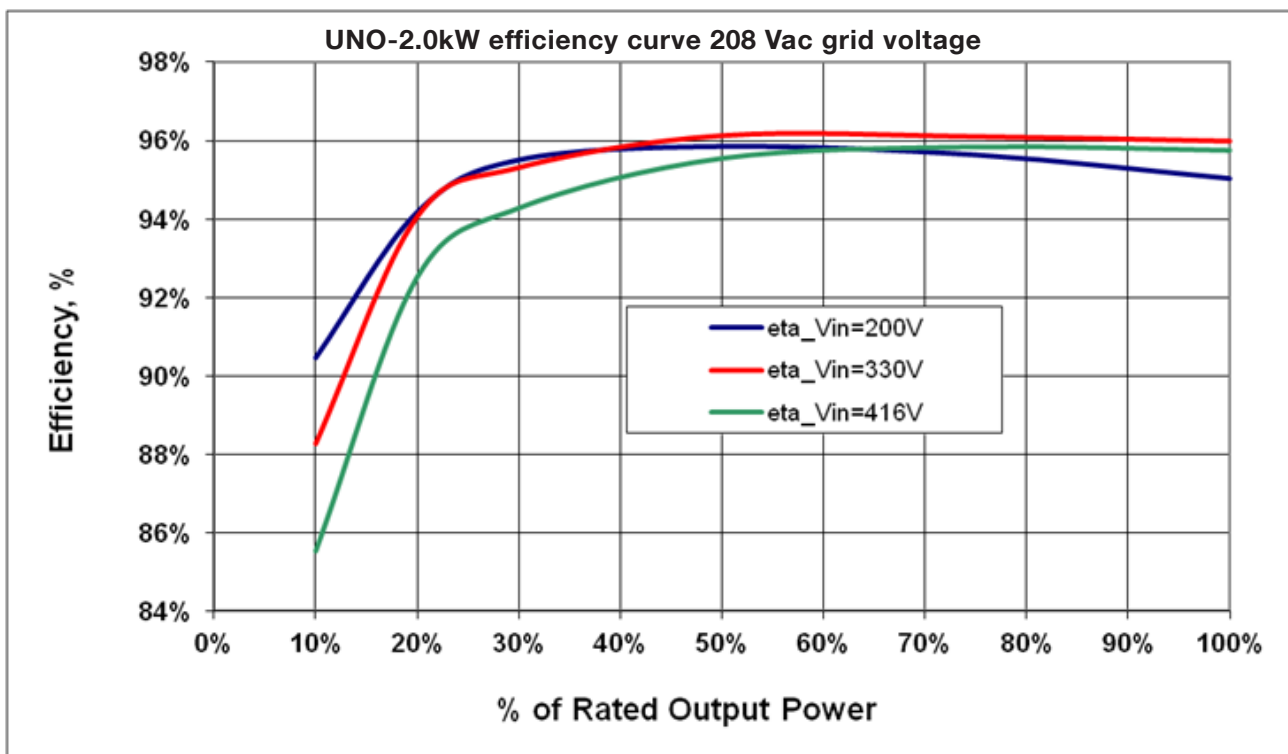



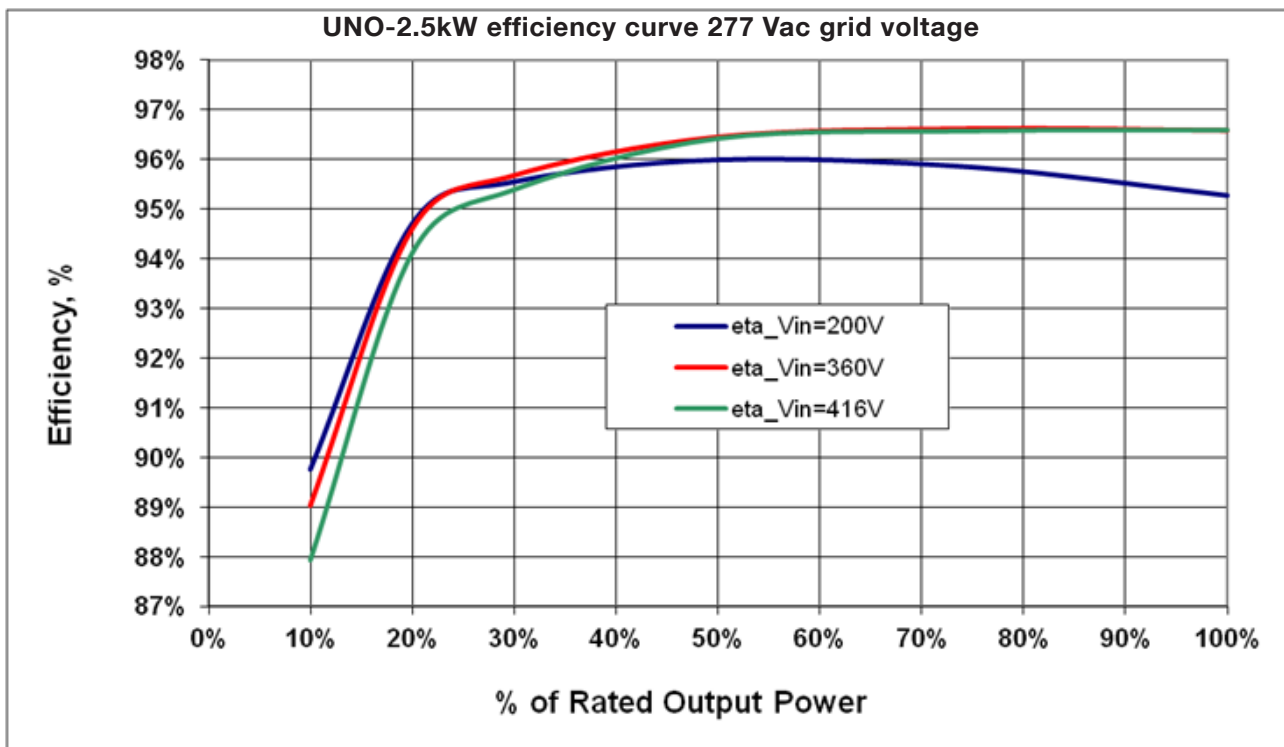
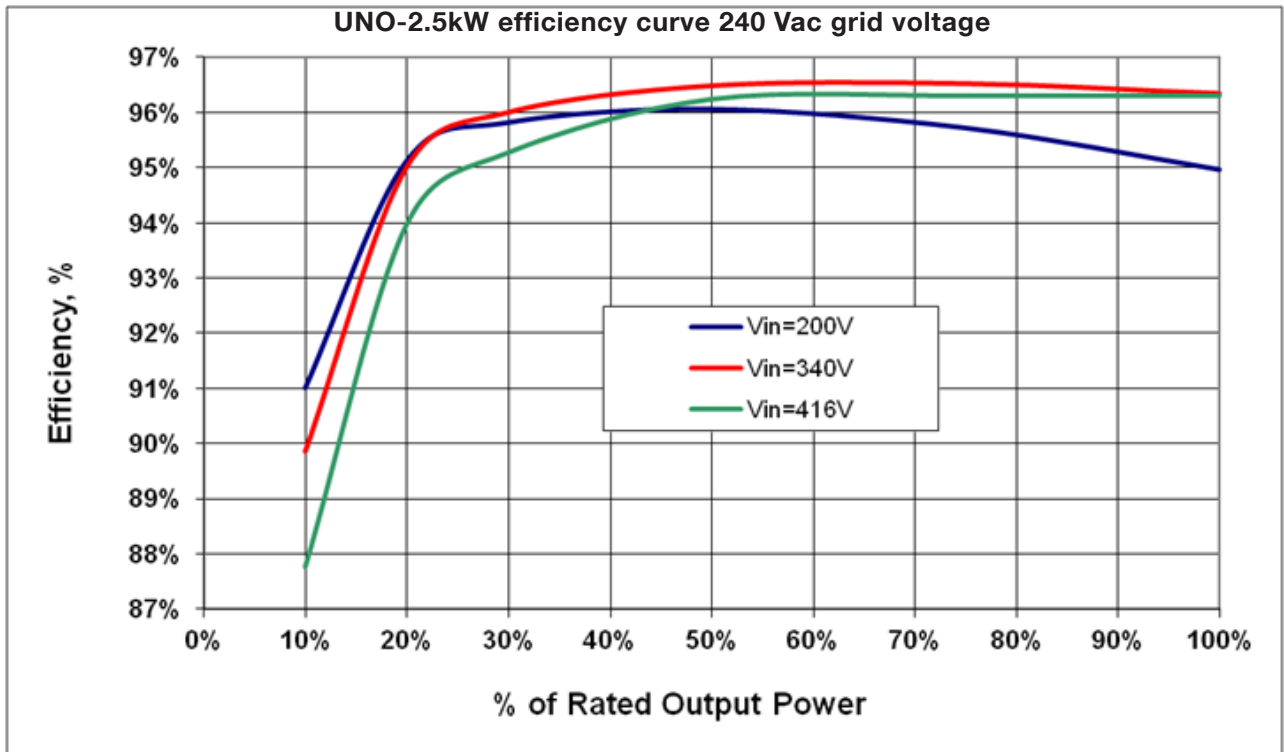

# Automatic power reduction

In order to maintain safe inverter operation under adverse environmental conditions or due to improper input voltages, the unit automatically reduces the amount of power it feeds to the grid. The conditions for power reduction due to environmental conditions and input voltage can occur at the same time, but the power reduction will always be determined by the more severe factor.

## Power reduction due to temperature

Power reduction due to ambient or inverter temperature depends on many operating parameters, such as input voltage, grid voltage and power available from the photovoltaic arrays. The inverter may reduce its output power during the day according to the value of these parameters. The following graphs show the automatic reduction in output power in relation to ambient temperature.

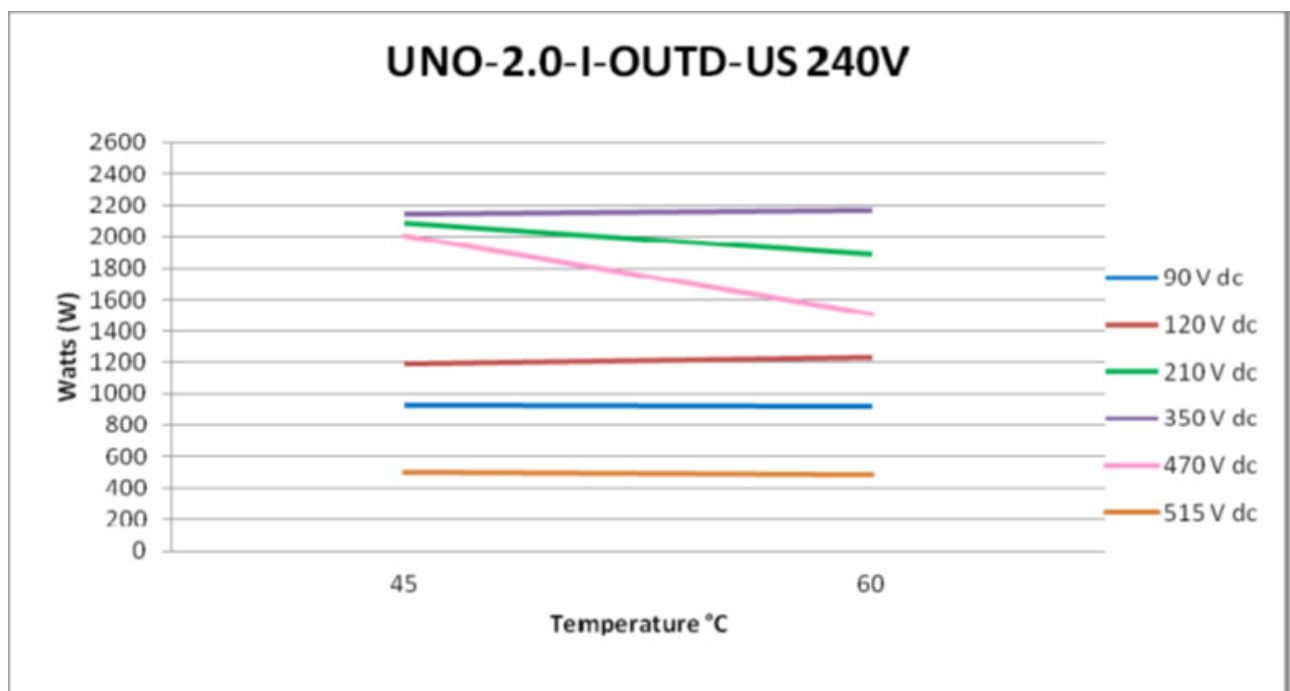
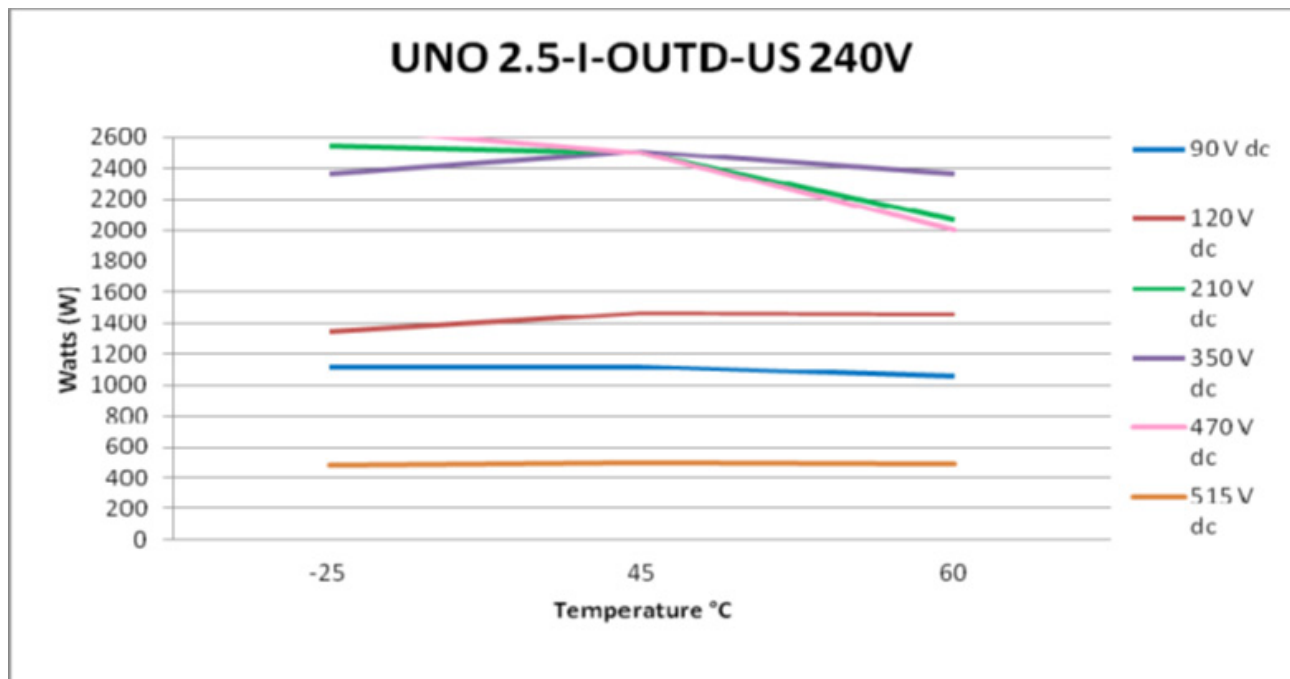

**Power reduction due to input voltage**

The following graphs show the automatic reduction in output power when the input voltage is too high or too low.

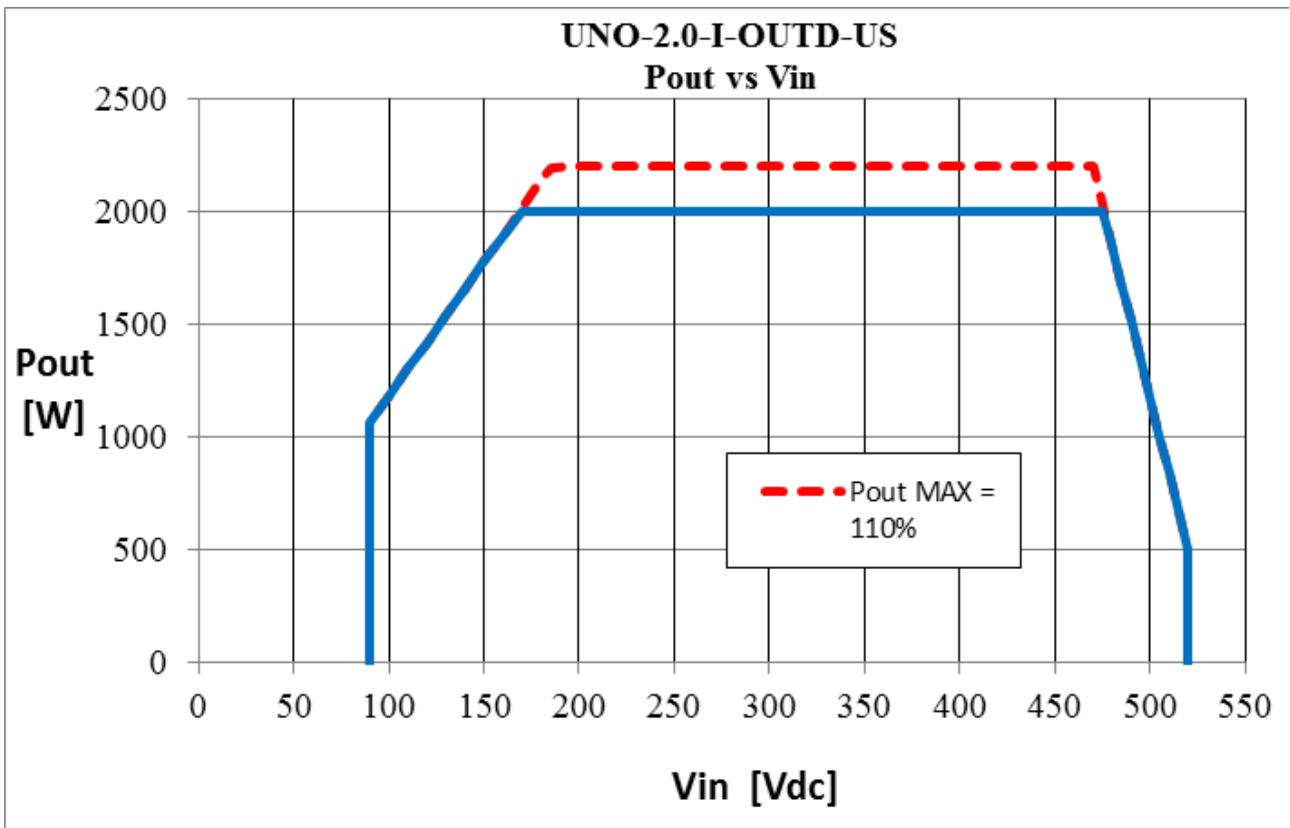
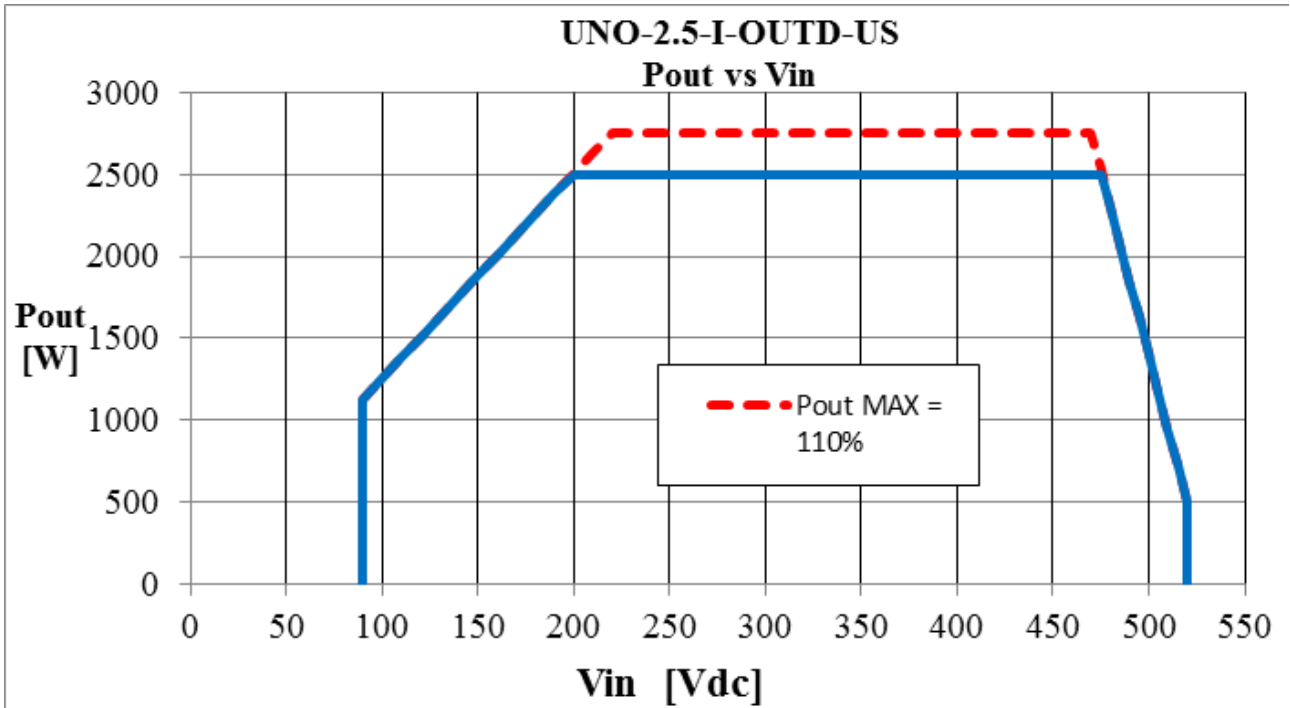

# Technical data and types

Type code	UNO-2.0-I-OUTD-S-US			UNO-2.5-I-OUTD-S-US		
Nominal output power	2000W			2500W		
Maximum output power	2200W <sup>1</sup>			2750W <sup>1</sup>		
Rated grid AC voltage	208V	240V	277V	208V	240V	277V
<b>Input side (DC)</b>						
Number of independent MPPT channels	1					
Maximum usable power for each channel	2300W					
Absolute maximum voltage (Vmax)	520V					
Start-up voltage (Vstart)	200V (adj. 120-350V)					
Full power MPPT voltage range	170-470V			205-470V		
Operating MPPT voltage range	0.7xVstart-520					
Maximum usable current per channel	12.5A			12.8A		
Maximum short circuit current limit per channel	15A					
Number of wire landing terminals per channel	2 pairs					
Array wiring termination	Terminal block, pressure clamp, 20AWG-6AWG					
<b>Output side (AC)</b>						
Grid connection type	1Ø/2W	Split-Ø/3W	1Ø/2W	1Ø/2W	Split-Ø/3W	1Ø/2W
Adjustable voltage range	183V-228V	211V-264V	244V-304V	183V-228V	211V-264V	244V-304V
Grid frequency	60Hz					
Adjustable grid frequency range	57Hz-60.5Hz					
Maximum current	10A			12A		
Power Factor	>0.990			>0.990		
Total harmonic distortion (@ rated output power)	<2%					
Grid wiring termination type	Terminal block, pressure clamp AWG20-AWG6					
<b>Input protection devices</b>						
Reverse polarity protection	Yes					
Over-voltage protection type	Varistor, 2					
PV array ground fault detection	Meets UL1741 / NEC 690.5 requirements					
PV array isolation control	GFDI (for use with either positive or negative grounded arrays)					
<b>Output protection devices</b>						
Anti-islanding protection	Meets UL 1741/IEEE 1547 requirements					
Over-Voltage protection type	Varistor, 2 (L <sub>1</sub> - L <sub>2</sub> / L <sub>1</sub> - G)					
Maximum AC OCPD Rating	15A					
<b>Efficiency</b>						
Maximum efficiency	96.6%					
CEC efficiency	95.5%	95.5%	95.5%	95.5%	96%	96%
<b>Operating performance</b>						
Night time consumption	<0.6W <sub>RMS</sub>					
Stand by consumption	< 8W <sub>RMS</sub>					
<b>Communication</b>						
User-interface	5.5" x 1.25" graphic display					
Remote monitoring (1xRS485 incl.)	VSN700 Data Logger (opt.)					
<b>Environmental</b>						
Ambient air operating temperature range	-13°F to 140°F (-25°C to +°C) with derating above 122°F (50°C)					
Ambient air storage temperature range	-40°F to 176°F (-40°C to +80°C)					
Relative humidity	0-100% condensing					
Acoustic noise emission level	<50 db (A) @ 1m					
Maximum operating altitude without derating	6560 ft (2000m)					
<b>Mechanical specifications</b>						
Enclosure rating	NEMA 4X					
Cooling	Natural convection					
Dimensions (H x W x D)	30.3 x 14.4 x 6.3in (769 x 367 x 161mm)					
Weight	<42.5lb (19.3 kg)					
Mounting system	Wall bracket					
Conduit connections <sup>2</sup>	Bottom: (2) 3/4" KO, (3) 1/2" KO / Left and right side: (1) 3/4" KO / Back: (4) 3/4" KO					
DC switch rating (per contact) (A/V)	16A / 6000Vdc					
<b>Safety</b>						
Isolation level	High-frequency transformer					
Safety and EMC standard	UL 1741, IEE1547, IEE1547.1, CSA-C22.2N. 107.1-01, UL1998 UL 1699B, FCC Part 15 Class B					
Safety Approval	cCSA <sub>us</sub>					
<b>Warranty</b>						
Standard warranty	10 years					
Extended warranty	15 & 20 years					
<b>Available models</b>						
Standard	UNO-2.0-I-OUTD-US			UNO-2.5-I-OUTD-US		
With DC switch and wiring box	UNO-2.0-I-OUTD-S-US			UNO-2.5-I-OUTD-S-US		
With DC switch, wiring box and Arc Fault detector and interruptor	UNO-2.0-OUTD-S-US-A			UNO-2.5-OUTD-S-US-A		

1. Capability enabled at nominal AC voltage and with sufficient DC power available

2. When equipped with optional DC switch and wiring box

All data is subject to change without notice

## Further information

For more information on ABB products and services for solar applications, navigate to [www.abb.com/solarinverters](http://www.abb.com/solarinverters)

# Contact us

[www.abb.com/solarinverters](http://www.abb.com/solarinverters)

UNO-2.0-2.5-I-OUTD-(X)-US product manual  
BCM.V0E02.1\_AA Rev 1.0  
© Copyright 2014 ABB. All Rights Reserved.