

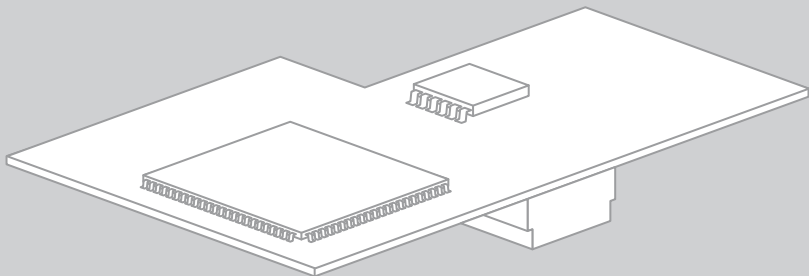

Communication Interface for SMA Inverters

SMA SPEEDWIRE/WEBCONNECT Piggy-Back

Installation Manual



Legal Provisions

Copyright © 2013 SMA America, LLC. All rights reserved.

No part of this document may be reproduced, stored in a retrieval system, or transmitted, in any form or by any means, be it electronic, mechanical, photographic, magnetic or otherwise, without the prior written permission of SMA America, LLC.

Neither SMA America, LLC nor SMA Solar Technology Canada Inc. makes representations, express or implied, with respect to this documentation or any of the equipment and/or software it may describe, including (with no limitation) any implied warranties of utility, merchantability, or fitness for any particular purpose. All such warranties are expressly disclaimed. Neither SMA America, LLC nor its distributors or dealers nor SMA Solar Technology Canada Inc. nor its distributors or dealers shall be liable for any indirect, incidental, or consequential damages under any circumstances.

(The exclusion of implied warranties may not apply in all cases under some statutes, and thus the above exclusion may not apply.)

Specifications are subject to change without notice. Every attempt has been made to make this document complete, accurate and up-to-date. Readers are cautioned, however, that SMA America, LLC and SMA Solar Technology Canada Inc. reserve the right to make changes without notice and shall not be responsible for any damages, including indirect, incidental or consequential damages, caused by reliance on the material presented, including, but not limited to, omissions, typographical errors, arithmetical errors or listing errors in the content material.

All trademarks are recognized even if these are not marked separately. Missing designations do not mean that a product or brand is not a registered trademark.

The *Bluetooth*[®] word mark and logos are registered trademarks owned by Bluetooth SIG, Inc. and any use of such marks by SMA America, LLC and SMA Solar Technology Canada Inc. is under license.

SMA America, LLC

3801 N. Havana Street
Denver, CO 80239 U.S.A.

SMA Solar Technology Canada Inc.

2425 Matheson Blvd. E
7th Floor
Mississauga, ON L4W 5K4
Canada

Important Safety Instructions

SAVE THESE INSTRUCTIONS

This manual contains important instructions for the following products:



- SMA Speedwire/Webconnect Piggy-Back

This manual must be followed during installation and maintenance.

The product is designed and tested in accordance with international safety requirements, but as with all electrical and electronic equipment, certain precautions must be observed when installing and/or operating the product. To reduce the risk of personal injury and to ensure the safe installation and operation of the product, you must carefully read and follow all instructions, cautions and warnings in this manual.





Warnings in this Document

A warning describes a hazard to equipment or personnel. It calls attention to a procedure or practice, which, if not correctly performed or adhered to, could result in damage to or destruction of part or all of the SMA equipment and/or other equipment connected to the SMA equipment or personal injury.

Symbol	Description
 DANGER	DANGER indicates a hazardous situation which, if not avoided, will result in death or serious injury.
 WARNING	WARNING indicates a hazardous situation which, if not avoided, could result in death or serious injury.
 CAUTION	CAUTION indicates a hazardous situation which, if not avoided, could result in minor or moderate injury.
NOTICE	NOTICE is used to address practices not related to personal injury.

Warnings on this Product

The following symbols are used as product markings with the following meanings.

Symbol	Description
	<p>Warning regarding dangerous voltage</p> <p>The product works with high voltages. All work on the product must only be performed as described in the documentation of the product.</p>
	<p>Electric arc hazards</p> <p>The product has large electrical potential differences between its conductors. Arc flashes can occur through air when high-voltage current flows. Do not work on the product during operation.</p>
	<p>Risk of fire</p> <p>Improper installation of the product may cause a fire.</p>
	<p>Beware of hot surface</p> <p>The product can become hot during operation. Do not touch the product during operation.</p>
	<p>Observe the operating instructions</p> <p>Read the documentation of the product before working on it. Follow all safety precautions and instructions as described in the documentation.</p>

General Warnings

WARNING

All electrical installations must be made in accordance with the local and *National Electrical Code*® ANSI/NFPA 70 or the *Canadian Electrical Code*® CSA C22.1. This document does not and is not intended to replace any local, state, provincial, federal or national laws, regulations or codes applicable to the installation and use of the product, including without limitation applicable electrical safety codes. All installations must conform with the laws, regulations, codes and standards applicable in the jurisdiction of installation. SMA assumes no responsibility for the compliance or non-compliance with such laws or codes in connection with the installation of the product.

The product contains no user-serviceable parts.

For all repair and maintenance, always return the unit to an authorized SMA Service Center.

Before installing or using the product, read all of the instructions, cautions, and warnings in this manual.

Before connecting the product to the electrical utility grid, contact the local utility company. This connection must be made only by qualified personnel.

Wiring of the product must be made by qualified personnel only.

Table of Contents

1	Information on this Document	9
2	Safety	11
2.1	Intended Use	11
2.2	Skills of Qualified Persons	12
2.3	Safety Precautions	12
2.4	Operating Instructions	13
2.5	Supported Products	13
3	Scope of Delivery	15
4	Product Description	16
4.1	SMA Speedwire/Webconnect Piggy-Back	16
4.2	Type Label	20
4.3	Cable Gland	21
5	Connection	22
5.1	Inverter Connection Area	22
5.2	Cable Requirements and Information on Routing	25
5.3	Connecting the Cable to the Communication Terminal	26
5.4	Installing the Piggy-Back	30
6	Commissioning	31
6.1	Commissioning a Large-Scale PV Power Plant with Cluster Controller	31
6.2	Commissioning a Small-Scale PV Plant	31
6.3	Managing Small-Scale PV Plants with Sunny Explorer	32
6.3.1	Functions and Parameter Settings in Sunny Explorer	32
6.3.2	Creating a Small-Scale PV Plant in Sunny Explorer	32
6.4	Plant Registration in Sunny Portal	33
6.4.1	Registering a Large-Scale PV Power Plant with Cluster Controller in Sunny Portal	33
6.4.2	Registering the Small-scale PV Plant in Sunny Portal	33

- 7 Decommissioning 35**
 - 7.1 Removing the Piggy-Back 35
 - 7.2 Packaging the Piggy-Back for Shipping 36
 - 7.3 Disposing of the Piggy-Back 36
- 8 Troubleshooting 37**
 - 8.1 General Errors 37
 - 8.2 Performing a Piggy-Back Update 38
- 9 Technical Data 39**
- 10 Compliance Information 40**
- 11 Contact 41**

1 Information on this Document





Validity

This document is valid for device type "SWPB-10.BG1" (SMA Speedwire/Webconnect Piggy-Back) from hardware version A and firmware version 1.00.00.R.

Target Group

This document is for qualified persons. Only persons with the appropriate skills are allowed to perform the tasks described in this document (see Section 2.2 "Skills of Qualified Persons", page 12).

Symbols

Symbol	Explanation
 DANGER	Indicates a hazardous situation which, if not avoided, will result in death or serious injury
 WARNING	Indicates a hazardous situation which, if not avoided, can result in death or serious injury
 CAUTION	Indicates a hazardous situation which, if not avoided, can result in minor or moderate injury
NOTICE	Indicates a situation which, if not avoided, could result in property damage
	Information that is important for a specific topic or goal, but is not safety-relevant
<input type="checkbox"/>	Indicates a requirement for meeting a specific goal
<input checked="" type="checkbox"/>	Desired result
x	A problem that could occur

Typographies

Typography	Explanation	Example
bold	<ul style="list-style-type: none"> • Display texts • Elements on a user interface • Terminals • Elements to be selected • Elements to be entered 	<ul style="list-style-type: none"> • The value can be found in the Energy field. • Select Settings. • Enter the value 10 in the Minutes field.
>	<ul style="list-style-type: none"> • Connects several elements to be selected 	<ul style="list-style-type: none"> • Select Settings > Date.
[Button/Key]	<ul style="list-style-type: none"> • Button or key to be selected or pressed 	<ul style="list-style-type: none"> • Select [Next].

Nomenclature

Complete designation	Designation in this document
Photovoltaics	PV
SMA America Production, LLC	SMA
SMA Solar Technology Canada Inc.	SMA
SMA Speedwire	Speedwire
SMA Cluster Controller	Cluster Controller
SMA Speedwire/Webconnect Piggy-Back	Piggy-Back
SMA Webconnect function	Webconnect function
SMA inverter	Inverter

Abbreviations

Abbreviation	Designation	Explanation
AC	Alternating Current	-
DC	Direct Current	-
DHCP	Dynamic Host Configuration Protocol	Protocol for the dynamic assignment of IP configurations
IP	Internet Protocol	-
MAC	Media Access Control	-
PIC	Product Identification Code	Identification key for registration in Sunny Portal
RID	Registration Identifier	Registration key for registration in Sunny Portal
UMTS	Universal Mobile Telecommunications	System succeeding GSM

2 Safety

2.1 Intended Use

The Speedwire/Webconnect Piggy-Back is a Speedwire communication interface with Webconnect function for inverters.

Speedwire is a wire-based type of communication based on the Ethernet standard and the communication protocol SMA Data2+. This enables inverter-optimized 10/100 Mbit data transmission between Speedwire devices in PV plants.

The Webconnect function enables direct data transmission between the inverters of a small-scale plant and the Internet portal Sunny Portal without any additional communication device and for a maximum of four inverters per Sunny Portal plant. For this, a Speedwire/Webconnect Piggy-Back must be installed in each of the inverters. You can access your Sunny Portal plant from any computer with an Internet connection.

The Speedwire/Webconnect Piggy-Back fulfills the following tasks:

- Set-up of a Speedwire network in small-scale and large-scale PV power plants
- Data exchange with the Internet portal Sunny Portal:
 - In small-scale PV plants via a router with Internet connection
 - In large-scale PV power plants via the Cluster Controller
- Data exchange with Sunny Explorer from software version 1.06

The Speedwire/Webconnect Piggy-Back is available as a retrofit kit.

The Speedwire/Webconnect Piggy-Back must only be operated with supported products (see Section 2.5, page 13).

For safety reasons, it is forbidden to modify the product or install components that are not explicitly recommended or distributed by SMA.

The type label must be permanently attached to the product.

Use the Speedwire/Webconnect Piggy-Back only in accordance with the enclosed documentation and with the local standards and directives. Any other use may cause injury to persons or property damage.

The enclosed documentation is an integral part of this product.

- Read and observe the documentation.
- Keep the documentation in a convenient place for future reference.

2.2 Skills of Qualified Persons

The tasks described in this document may only be performed by qualified persons. Qualified persons must have the following skills:

- Training in the installation and commissioning of electrical devices and plants
- Knowledge of how to deal with the dangers and risks associated with installation and operation of electrical devices and plants
- Knowledge of all applicable standards and directives
- Knowledge of how an inverter works and its operation
- Knowledge of and adherence to this document and all safety precautions

2.3 Safety Precautions

⚠ DANGER

Danger to life due to electric shock when opening the inverter

High voltages are present in the conductive components of the inverter.

- Prior to performing any work on the inverter, always disconnect the inverter from all voltage sources on the AC and DC sides (see inverter installation manual). Observe the waiting time to allow the capacitors to discharge.

⚠ CAUTION

Risk of burns due to hot inverter enclosure parts

Some parts of the inverter enclosure may get hot during operation. Touching these enclosure parts can result in burn injuries.

- Do not touch any parts other than the lower enclosure lid of the inverter during operation.

NOTICE

Damage to the inverter or the Speedwire/Webconnect Piggy-Back due to electrostatic discharge

The internal electronic components of the inverter or on the Speedwire/Webconnect Piggy-Back can be irreparably damaged by electrostatic discharge.

- Ground yourself before touching any electronic component.

2.4 Operating Instructions

NOTICE

High costs possible due to inappropriate Internet rates

When using the Webconnect function, a constant Internet connection is required.

Depending on the quality of the Internet connection, the data transfer volume for an inverter is between 150 MB and 550 MB per month. When using the plant overview in Sunny Portal with live data display, there is an additional data volume of 600 kB per hour.

- Since there is a constant Internet connection to Sunny Portal, time-based billing systems should be avoided. High costs could be incurred. SMA recommends using an Internet flat rate.

i If UMTS is used, VoIP is required

If UMTS is used, then use of the Webconnect function requires VoIP (Voice over IP).

- Ensure that the UMTS provider also provides the VoIP service.

2.5 Supported Products

SMA Inverters

The Speedwire/Webconnect Piggy-Back can only be used in the following inverters with at least the specified firmware version:

Sunny Boy	from firmware version
SB 5000US, SB 6000US, SB 7000US, SB 8000US	1.12
SB 6000TLUS-10, SB 7000TLUS-10, SB 8000TLUS-10, SB 9000TLUS-10, SB 10000TLUS-10	1.12
SB 5000US-11, SB 6000US-11, SB 7000US-11, SB 8000US-11	1.22
SB 3000US-12, SB 3800US-12, SB 4000US-12	3.04
SB 5000US-12, SB 6000US-12, SB 7000US-12, SB 8000US-12	2.00
SB 6000TLUS-12, SB 7000TLUS-12, SB 8000TLUS-12, SB 9000TLUS-12, SB 10000TLUS-12, SB 11000TLUS-12	1.93

If the firmware version of the inverter is lower than specified in the table above, you must perform a firmware update to the firmware version specified or higher for this inverter. Firmware updates on the inverters can only be carried out by SMA Service. If a firmware update is required, please contact the SMA Service Line (see Section 11, page 41).

Additional SMA Products

The Speedwire/Webconnect Piggy-Back can be configured with the following communication products:

- SMA Cluster Controller from firmware version 1.0
- Sunny Explorer from software version 1.06
- SMA Connection Assist from software version 1.00.8.R

Sunny Explorer and SMA Connection Assist are available free of charge at www.SMA-Solar.com.

3 Scope of Delivery

Check the scope of delivery for completeness and any externally visible damage. Contact your distributor if the scope of delivery is incomplete or if there is any damage.

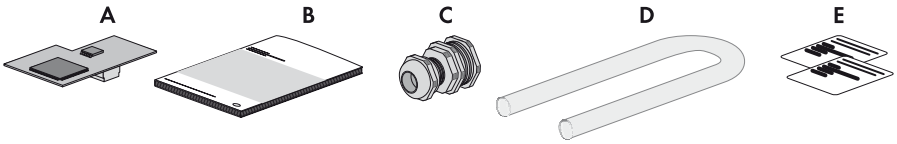

Figure 1: Components included in the scope of delivery

Item	Number	Designation
A	1	SMA Speedwire/Webconnect Piggy-Back (SWPB-10.BG1)
B	1	Installation manual
C	1	Cable gland
D	1	Insulating hose
E	2	Label with PIC and RID for registration in Sunny Portal

4 Product Description

4.1 SMA Speedwire/Webconnect Piggy-Back

The Speedwire/Webconnect Piggy-Back is a Speedwire communication interface with Webconnect function for inverters.

Speedwire is a wire-based type of communication based on the Ethernet standard and the communication protocol SMA Data2+. This enables inverter-optimized 10/100 Mbit data transmission between Speedwire devices in PV plants.

The Webconnect function enables direct data transmission between the inverters of a small-scale PV plant and the Internet portal Sunny Portal without any additional communication device and for a maximum of four inverters per Sunny Portal plant. For this, a Speedwire/Webconnect Piggy-Back must be installed in each of the inverters. You can access your Sunny Portal plant from any computer with an Internet connection.

The Speedwire/Webconnect Piggy-Back fulfills the following tasks:

- Set-up of a Speedwire network in small-scale and large-scale PV power plants
- Data exchange with the Internet portal Sunny Portal:
 - In small-scale PV plants via a router with Internet connection
 - In large-scale PV power plants via the Cluster Controller
- Data exchange with Sunny Explorer from software version 1.06

The Speedwire/Webconnect Piggy-Back is available as a retrofit kit.

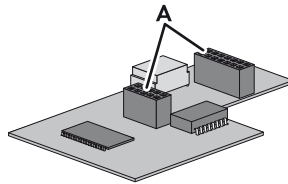

Figure 2: Design of the SMA Speedwire/Webconnect Piggy-Back

Item	Designation
A	Female connector

Label with PIC and RID for Registration of a Small-Scale PV Plant in Sunny Portal

To activate the Piggy-Back in Sunny Portal, you will need the PIC and RID numbers printed on the supplied label. After installation of the Piggy-Back, a label should be affixed on the exterior of the inverter in the vicinity of the type label. Keep the other label in a safe place for future reference.

Use in Small-Scale PV Plants with a Maximum of Four Inverters

A small-scale PV plant in Sunny Portal can consist of a maximum of four inverters with installed Speedwire/Webconnect Piggy-Back. The Speedwire network can be set up in either star or tree topology, depending on the devices used and the number of network connections.

The Speedwire/Webconnect Piggy-Back is equipped with one network terminal.

Depending on the small-scale PV plant, the computer with the Sunny Explorer software will be connected to the router or the network switch.

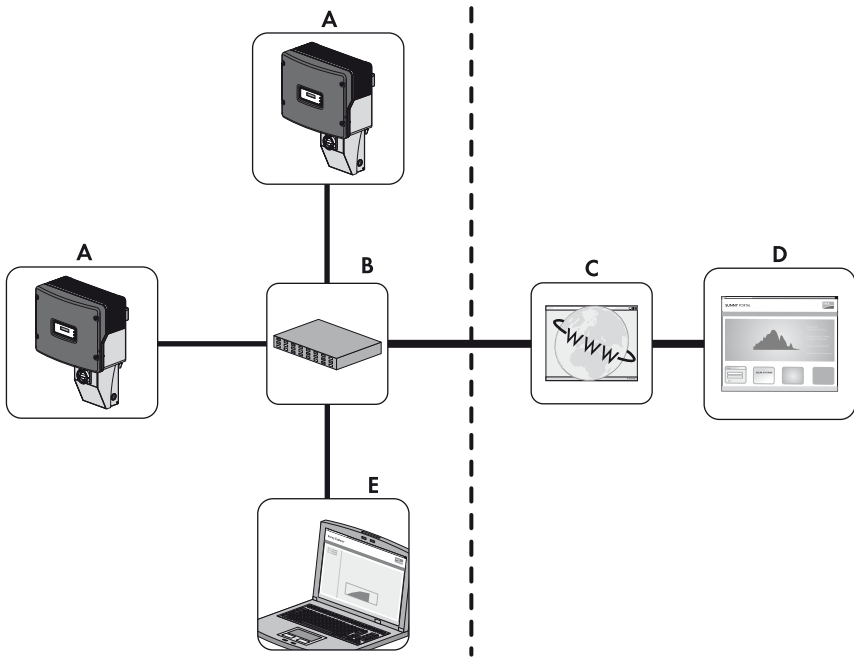

Figure 3: Small-scale PV plant with two inverters in star topology (example)

Item	Designation
A	Inverter with Piggy-Back
B	Router
C	Internet
D	Sunny Portal
E	Computer with Sunny Explorer

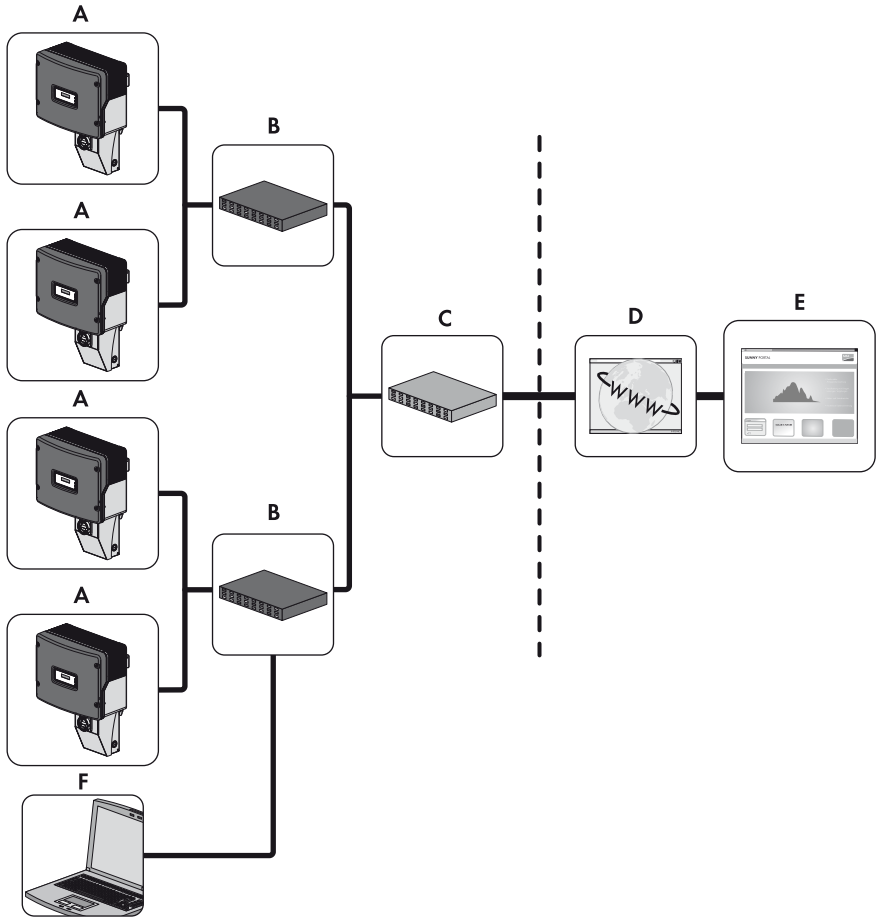

Figure 4: Small-scale PV plant with four inverters in tree topology (example)

Item	Designation
A	Inverter with Piggy-Back
B	Network switch
C	Router
D	Internet
E	Sunny Portal
F	Computer with Sunny Explorer

Use in Large-Scale PV Power Plants with Cluster Controller

The Speedwire network in large-scale PV power plants can be set up in a tree topology. Data exchange with Sunny Portal does not take place via the individual inverters, but centrally via the Cluster Controller (see user manual of the Cluster Controller and user manual of the Cluster Controller in Sunny Portal).

i **Deactivation of the Webconnect function of inverters in large-scale PV power plants with Cluster Controller**

In large-scale PV power plants with Cluster Controller, communication with Sunny Portal takes place via the Cluster Controller itself.

- For optimal operation of large-scale PV power plants with Cluster Controller, deactivate the Webconnect function of the inverters with integrated Piggy-Back (see Cluster Controller user manual).

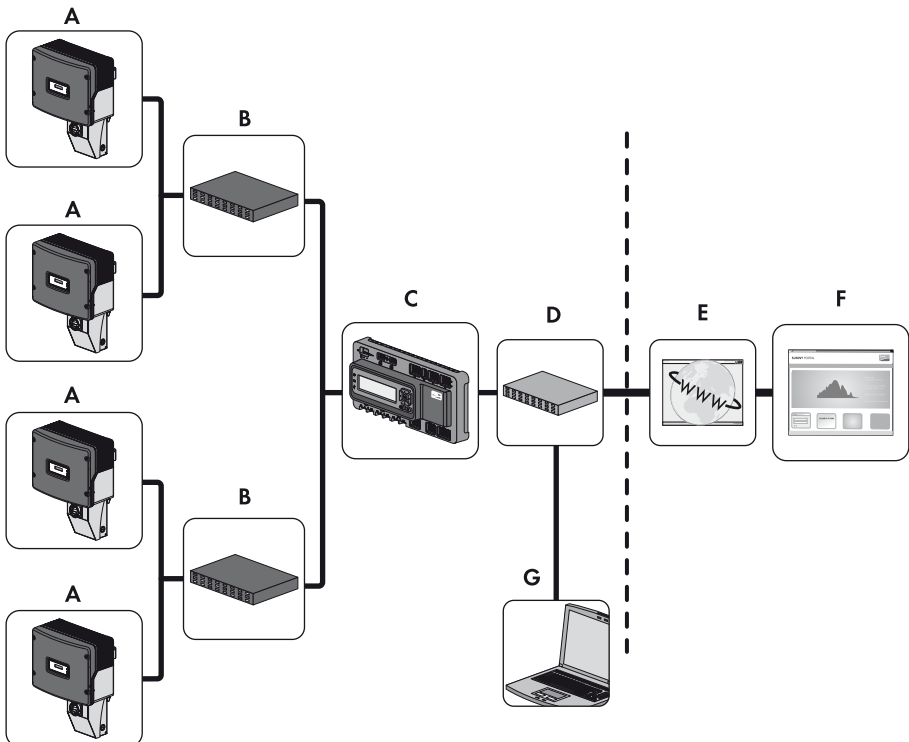

Figure 5: Large-scale PV power plant with Cluster Controller and inverters in tree topology (example)

Item	Designation
A	Inverter with Piggy-Back

Item	Designation
B	Network switch
C	Cluster Controller
D	Router
E	Internet
F	Sunny Portal
G	Computer with access to the user interface of the Cluster Controller

4.2 Type Label

The type label clearly identifies the product. The type label is located on the front of the product.

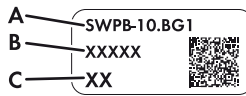

Figure 6: Design of the type label

Item	Explanation
A	Device type
B	Serial number
C	Hardware version

You will require the information on the type label to use the product safely and when seeking customer support from the SMA Service Line. The type label must be permanently attached to the product.

Supplementary Label with Data for Registration in Sunny Portal

The supplementary label is located on the front of the product. The data for registration in Sunny Portal is to be found on the supplementary labels supplied. You can read the following data from the supplementary label:

- PIC
- RID
- MAC address (MAC Address)

Symbol on the Supplementary Label

Symbol	Designation	Explanation
	CE marking	The product complies with the requirements of the applicable EU directives.

4.3 Cable Gland

The cable gland provides a sturdy, tightly sealed connection of the network cables with the inverter enclosure. The cable gland also protects the inverter from dust and moisture intrusion.

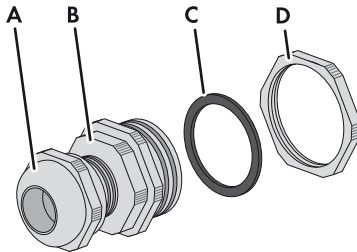

Figure 7: Design of the cable gland

Item	Designation
A	Swivel nut
B	Adapter
C	Sealing ring
D	Counter nut

5 Connection

5.1 Inverter Connection Area

SB x000US-12

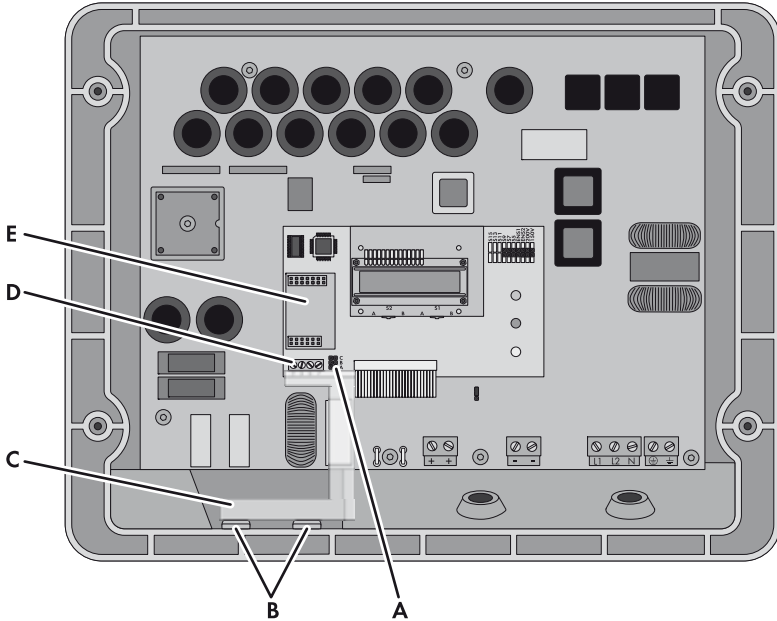

Figure 8: Overview of the connection area

Item	Designation
A	Jumper slot for communication
B	Inverter enclosure opening with filler plug
C	Cable route to communication terminal
D	Communication terminal
E	Slot for Piggy-Back

SB 5000US, 6000US, SB 7000US, SB 8000US

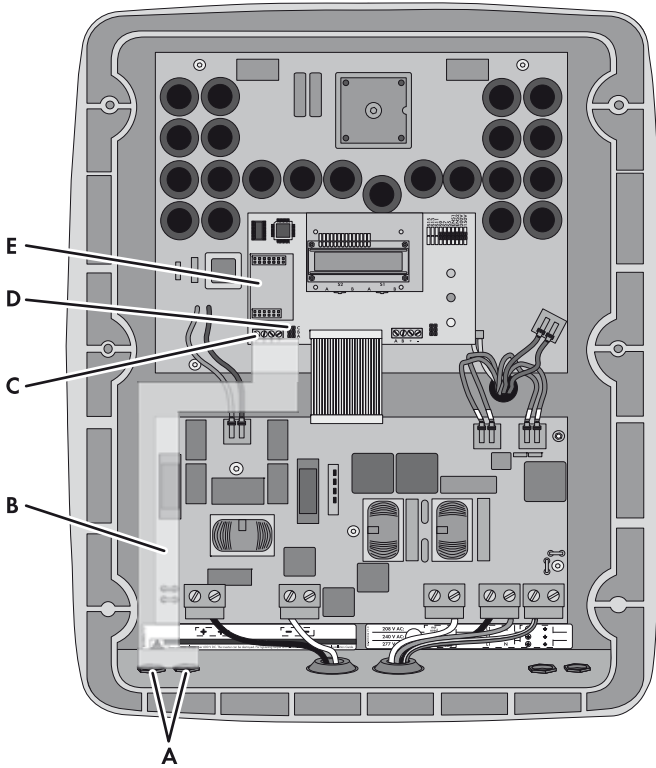

Figure 9: Overview of the connection area

Item	Designation
A	Inverter enclosure opening with filler plug
B	Cable route to communication terminal
C	Communication terminal
D	Jumper slot for communication
E	Slot for Piggy-Back

SB 6000TL-US, SB 7000TL-US, SB 8000TL-US, SB 9000TL-US, SB 10000TL-US, SB 11000TL-US

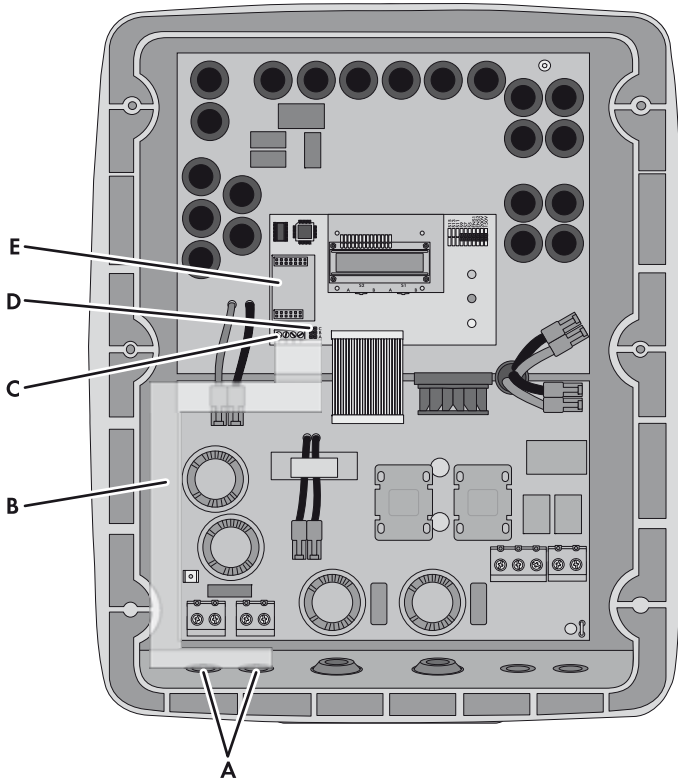

Figure 10: Overview of the connection area

Item	Designation
A	Inverter enclosure opening with filler plug
B	Cable route to communication terminal
C	Communication terminal
D	Jumper slot for communication
E	Slot for Piggy-Back

5.2 Cable Requirements and Information on Routing

The cable length and quality have an effect on the signal strength in the Speedwire network. Observe the following cable requirements and the information on laying them.

i Disturbance in data transmission due to AC cables

If unshielded power cables are used, they generate an electromagnetic field during operation which may induce interference in network cables during data transmission.

- When laying network cables, observe the following minimum clearances to unshielded power cables:
 - For installation without separating strip: at least 8 in. (200 mm)
 - For installation with aluminum separating strip: at least 4 in. (100 mm)
- For installation with steel separating strip: at least 2 in. (50 mm)

Cable Requirements

- UL-listed cable with a minimum insulation voltage of 600 V
- Cable length between two nodes: max. 328 ft. (100 m)
- Cross-section: at least 2 x 2 x 24 AWG or at least 2 x 2 x 0.22 mm²
- Cable type: 100BaseTx, CAT5 with shielding S-UTP, F-UTP or higher
- UV-resistant for outdoor use
- Type of plug: RJ45

SMA recommends the following cable type:

- SMA COMCAB-OUTxxx

The cable is available in the lengths xxx = 328 ft. (100 m), 656 ft. (200 m), 1,640 ft. (500 m), 3,280 ft. (1,000 m)

5.3 Connecting the Cable to the Communication Terminal

Observe local regulations

All electrical installations must be carried out in accordance with the electrical standards applicable on site and the *National Electrical Code*® (NE, ANSI/NFPA 70). Installations in Canada must comply with the applicable Canadian standards.

Figures in this section

All the steps in this section are supported by figures of the inverter types SB 3000US, SB 3800US and SB 4000US. The procedure for other inverter types is analogous (see Section 5.1 "Inverter Connection Area", page 22).

Additionally required material (not included in the scope of delivery):

- 1 network cable (see Section 5.2 "Cable Requirements and Information on Routing", page 25)
- 4 bootlace ferrules
Only use UL R/C Crimps (bootlace ferrules) with the manufacturer stated crimping tool.
- 1 RJ45 connector
- If the network cable is to be routed in a conduit:
 - 1 rain-tight conduit fitting or conduit fitting for wet locations (diameter: 1 in.)
 - 1 conduit (diameter: 1 in.)

Procedure:

1. **DANGER**

Danger to life due to electric shock when opening the inverter

High voltages are present in the conductive components of the inverter. Touching live components results in death or serious injury.

- Disconnect the inverter from voltage sources on the AC and DC sides and open it (see the inverter installation manual). Observe the waiting time to allow the capacitors to discharge.
2. Push one filler plug from the inside out of the bottom of the inverter enclosure.
 3. If a conduit is to be used, proceed as follows:
 - Insert one rain-tight conduit fitting or conduit fitting for wet locations (diameter: 1 in. [25.4 mm]) in the enclosure opening and tighten from the inside using a counter nut.
 - Attach one conduit (diameter: 1 in. [25.4 mm]) to the enclosure opening.
 - Lead the cable through the conduit into the inverter.
 - Ground the cable shield at the inverter enclosure.

4. If no conduit is to be used, proceed as follows:

- Unscrew the counter nut of the cable gland.
- Push the sealing ring onto the adapter.

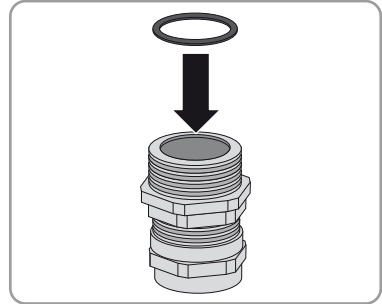

- Attach the cable gland to the enclosure opening using the counter nut. Ensure that the grooved side of the counter nut is facing the inverter enclosure.

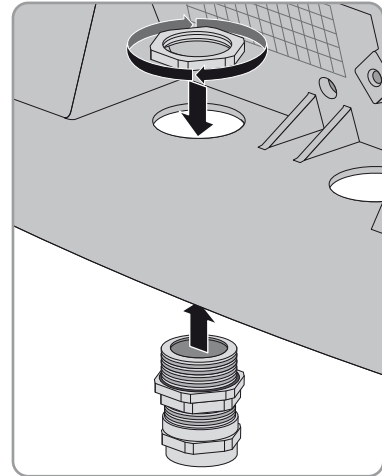

- Gauge the length from the communication terminal to the counter nut on the cable gland with the cable, and mark the position on the cable. Be sure to take the permitted cable route into account (see Section 5.1 "Inverter Connection Area", page 22).
- Below the marked position, remove $\frac{3}{4}$ in. (20 mm) from the cable sheath. This will enable contact between the shield clamp in the cable gland and the cable shield.

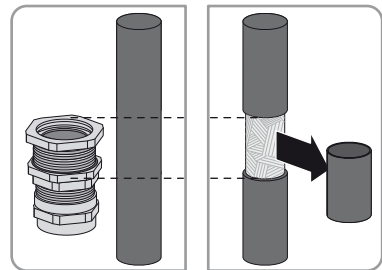

- Unscrew the swivel nut of the cable gland but do not remove it.
- Gradually guide the end of the cable through the cable gland into the inverter, until you can hear the shield clamp grip onto the cable shield.

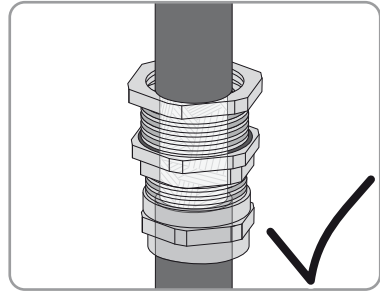

- Tighten the swivel nut of the cable gland. This will prevent the cable from slipping and the contact between shield clamp and cable shield being lost.
5. At the cable end, remove 1 1/2 in. (40 mm) from the cable sheath and the cable shield. Make sure that no pieces of cable are dropped into the inverter.
 6. At the end of the cable, strip the insulation from the required four conductors by 1/4 in. (6 mm). Take the type of cable into account, as listed below:

Network cable			
Signal	EIA/TIA 568A (8-conductor) Conductor color	EIA/TIA 568B (8-conductor) Conductor color	Profinet (4-conductor) Conductor color
TD+	white/green	white/orange	yellow
TD-	green	orange	orange
RD+	white/orange	white/green	white
RD-	orange	green	blue

7. Shorten all other conductors flush with the cable sheath.
8. Attach the bootlace ferrules to the conductor ends. Only use UL R/C crimps (bootlace ferrules) with the crimping tool specified by the manufacturer.

9. **⚠ DANGER**

Danger to life due to electric shock in case of incorrect cable insulation

In case of incorrect cable insulation, high voltages may occur on the cable outside the inverter.

- Guide the cable in the inverter through the insulating hose. The insulating hose must completely cover the cable and the conductors inside the inverter enclosure.
- Cut the insulating hose to the required length, as necessary.
- Fix the insulating hose in position at the beginning and end of the cable, as necessary, using cable ties. Cut off the ends of the cable ties. This will prevent the ends of the cable ties causing damage to hot components in the inverter.

10. Connect the conductor ends to the communication terminal in the inverter at screw terminals **2, 3, 5** and **7** (torque: 0.23 Nm). Observe the permitted cable route (see Section 5.1 "Inverter Connection Area", page 22) and the contact pin assignment as follows:

Inverter communication terminal Contact pin	Network cable			
	Signal	EIA/TIA 568A (8-conductor) Conductor color	EIA/TIA 568B (8-conductor) Conductor color	Profinet (4-conductor) Conductor color
2	TD+	white/green	white/orange	yellow
3	TD-	green	orange	orange
7	RD+	white/orange	white/green	white
5	RD-	orange	green	blue

11. Make sure no jumpers are set at the jumper slot for communication.

12. Attach an RJ45 connector to the other end of the cable (see manufacturer's manual). Observe the contact pin assignment of the network cable, as follows:

Network cable				
Signal	Contact pin RJ45 plug	EIA/TIA 568A (8-conductor) Conductor color	EIA/TIA 568B (8-conductor) Conductor color	Profinet (4-conductor) Conductor color
TD+	1	white/green	white/orange	yellow
TD-	2	green	orange	orange
RD+	3	white/orange	white/green	white
RD-	6	orange	green	blue

13. Subject to the required network topology, connect the other end of the cable to a router or network switch (see manual of the respective device). To do this, there must be a router with Internet connection connected to the PV plant.

5.4 Installing the Piggy-Back

1. **⚠ DANGER**

Danger to life due to electric shock when opening the inverter

High voltages are present in the conductive components of the inverter. Touching live components results in death or serious injury.

- If the inverter is closed, disconnect the inverter from voltage sources on the AC and DC sides and open it (see the inverter installation manual). Observe the waiting time to allow the capacitors to discharge.
2. Plug the Piggy-Back into the slot in the inverter with the female connectors (see Section 5.1 "Inverter Connection Area", page 22).

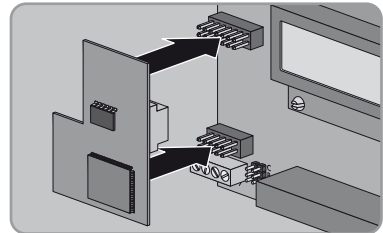

3. Stick one of the labels with the data for registration in Sunny Portal (PIC and RID) on the outside of the inverter in the vicinity of the type label.
4. Close the inverter (see inverter installation manual).

6 Commissioning

6.1 Commissioning a Large-Scale PV Power Plant with Cluster Controller

Requirements:

- The Piggy-Backs must be installed in the inverters (see Section 5.4, page 30).
- The Piggy-Backs must be connected (see Section 5.3, page 26).
- The Cluster Controller must be connected to the Speedwire network in accordance with the desired network topology (see installation manual of the Cluster Controller).

Procedure:

1. Commission all inverters (see inverter installation manual).
2. For optimal operation of large-scale PV power plants with Cluster Controller, deactivate the Webconnect function of the inverters with integrated Piggy-Back (see Cluster Controller user manual). In large-scale PV power plants with Cluster Controller, communication with Sunny Portal takes place via the Cluster Controller itself.

6.2 Commissioning a Small-Scale PV Plant

Requirements:

- The cable must be connected to the communication terminal (see Section 5.3, page 26).
- The Piggy-Back must be installed in the inverter (see Section 5.4, page 30).
- There must be a router in the local network of the PV plant.
- At least one inverter must be connected to the router.
- If the IP addresses in the local network are to be assigned dynamically, DHCP must be activated in the router (see the router manual). If you do not want to use DHCP or your router does not support DHCP, use either the SMA Connection Assist or Sunny Explorer to integrate the inverters with Piggy-Back into the local network (see Section 2.5 "Supported Products", page 13).

Procedure:

- Commission all inverters (see inverter installation manual).

6.3 Managing Small-Scale PV Plants with Sunny Explorer

6.3.1 Functions and Parameter Settings in Sunny Explorer

The following functions for small-scale PV plant management in Sunny Explorer are available:

- Overview of the status of the small-scale PV plant
- Graphic display of key plant data, device data and energy values
- Parameterization of individual devices or an entire device class
- Simple diagnostics thanks to display of faults and events
- Data export of inverter energy values and events in CSV format
- Piggy-Back update

You can change the following parameters in Sunny Explorer:

- Device name of the inverter
- Automatic IP configuration On/Off
- DNS-IP, gateway IP, IP address, subnet mask
- Webconnect function On/Off

6.3.2 Creating a Small-Scale PV Plant in Sunny Explorer

Requirements:

- The small-scale PV plant must be commissioned (see Section 6.2, page 31).
- The inverter with Piggy-Back must be in feed-in operation.
- Sunny Explorer must be installed on the computer (see Section 2.5 "Supported Products", page 13).

Procedure:

1. Connect the computer to the router/network switch of the small-scale PV plant using a network cable.
2. If you have used the SMA Connection Assist for the static network configuration, ensure that the SMA Connection Assist has ended.
3. Start Sunny Explorer and create a Speedwire plant for the small-scale PV plant in Sunny Explorer (see Sunny Explorer help).

6.4 Plant Registration in Sunny Portal

6.4.1 Registering a Large-Scale PV Power Plant with Cluster Controller in Sunny Portal

Requirements:

- The large-scale PV power plant with Cluster Controller must be commissioned (see Section 6.1, page 31).
- The computer must have an Internet connection.
- The Cluster Controller must be connected to a router with Internet connection (see installation manual of the Cluster Controller).
- JavaScript must be activated in the Internet browser.

Procedure:

- In large-scale PV power plants with Cluster Controller, register in Sunny Portal via the user interface of the Cluster Controller (see user manual of the Cluster Controller).

6.4.2 Registering the Small-Scale PV Plant in Sunny Portal

Requirements:

- The small-scale PV plant must be commissioned (see Section 6.2, page 31).
- The inverter with Piggy-Back must be in feed-in operation.
- The small-scale PV plant must be connected to a router with permanent Internet connection (see router manual).
- PIC and RID must be available for the Piggy-Back.
- The computer must have an Internet connection.
- JavaScript must be activated in the Internet browser.

i Maximum permissible number of devices for a small-scale PV plant in Sunny Portal

In Sunny Portal you can manage several small-scale PV plants. A maximum of four inverters with integrated Piggy-Back per small-scale PV plant is permissible.

i Small-scale PV plant with Piggy-Back cannot be combined with other small-scale PV plants

If you already have a small-scale PV plant registered in Sunny Portal with another communication device, e.g. Sunny WebBox, you will still need to create a separate small-scale PV plant with Piggy-Back. It is not possible to combine the Piggy-Back and other communication devices within one Sunny Portal plant. Sunny Portal treats the existing small-scale PV plant and the new small-scale PV plant with Piggy-Back as separate Sunny Portal plants.

- Create a new small-scale PV plant with Piggy-Back.



Replacing Piggy-Back in the inverter

If you have replaced the Piggy-Back in the inverter with a new Piggy-Back, the inverter's PIC and RID will change. Therefore, you must also replace the inverter using the Plant Setup Assistant in Sunny Portal (see the Sunny Portal user manual). In the Plant Setup Assistant, you must enter the PIC and the RID of the new Piggy-Back.

Starting the Plant Setup Assistant in Sunny Portal

The Plant Setup Assistant is a step-by-step guide to the processes required for user registration and the registration of your small-scale PV plant in Sunny Portal

1. Go to **www.SunnyPortal.com**.
2. Select [**Plant Setup Assistant**].
 - The Plant Setup Assistant opens.
3. Follow the instructions of the Plant Setup Assistant.

7 Decommissioning

7.1 Removing the Piggy-Back

1. **⚠ DANGER**

Danger to life due to electric shock when opening the inverter

High voltages are present in the conductive components of the inverter. Touching live components results in death or serious injury.

- Disconnect the inverter from voltage sources on the AC and DC sides and open it (see the inverter installation manual). Observe the waiting time to allow the capacitors to discharge.
2. Open the inverter (see inverter installation manual).
 3. Remove the Piggy-Back from the communication interface.

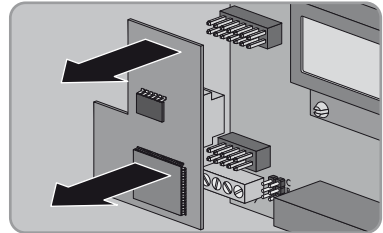

4. Release the screw terminals at the communication terminal in the inverter and remove the conductors.
5. Remove the insulating hose from the cable.
6. If you are not using a conduit:
 - Unscrew the swivel nut of the cable gland.
 - Pull the cable out of the inverter.
 - Unscrew the counter nut of the cable gland and remove cable gland.
7. If you are using a conduit, unscrew the counter nut of the conduit fitting and remove the conduit fitting, conduit and cable.
8. Seal the enclosure opening of the inverter with the corresponding filler plug.
9. Close the inverter (see inverter installation manual).

7.2 Packaging the Piggy-Back for Shipping

- Pack the Piggy-Back ready for shipping. To do so, use the original packaging or packaging that is suitable for the weight and size of the Piggy-Back (see Section 9 "Technical Data", page 39).

7.3 Disposing of the Piggy-Back

- Dispose of the Piggy-Back in accordance with the regulations for the disposal of electronic waste applicable at the installation site.

8 Troubleshooting

8.1 General Errors

Problem	Cause and corrective measures
Inverter with Piggy-Back cannot be accessed.	<p data-bbox="403 295 728 327">There is no Speedwire connection.</p> <p data-bbox="403 343 627 375">Corrective measures:</p> <ul data-bbox="436 383 1012 582" style="list-style-type: none"> <li data-bbox="436 383 1012 414">• Ensure that all network cable plugs are inserted and locked. <li data-bbox="436 422 1012 454">• Ensure that all inverters in the PV plant are in operation. <li data-bbox="436 462 1012 494">• Make sure that the PV plant router is switched on. <li data-bbox="436 502 1012 582">• Ensure that the Piggy-Back is correctly connected (see Section 5.3 "Connecting the Cable to the Communication Terminal", page 26).
	<p data-bbox="403 598 884 654">The firmware version of the inverter is not supported (see Section 2.5 "Supported Products", page 13).</p> <p data-bbox="403 670 627 702">Corrective measures:</p> <ul data-bbox="436 710 1012 829" style="list-style-type: none"> <li data-bbox="436 710 1012 829">• An inverter firmware update can only be carried out by SMA Service. If a firmware update of your inverter is required, please contact the SMA Service Line (see Section 11, page 41).
	<p data-bbox="403 837 996 893">The software version of the Sunny Explorer is older than software version 1.06.</p> <p data-bbox="403 909 627 941">Corrective measures:</p> <ul data-bbox="436 949 1012 1013" style="list-style-type: none"> <li data-bbox="436 949 1012 1013">• Download Sunny Explorer with minimum software version 1.06 from www.SMA-Solar.com and install.
	<p data-bbox="403 1021 795 1045">Firewall or IP filter settings are not correct.</p> <p data-bbox="403 1061 627 1093">Corrective measures:</p> <ul data-bbox="436 1101 1012 1165" style="list-style-type: none"> <li data-bbox="436 1101 1012 1165">• Adjust firewall or IP filter settings (see firewall or router manual).
	<p data-bbox="403 1173 862 1197">The Piggy-Back does not have a valid IP address.</p> <p data-bbox="403 1212 627 1244">Corrective measures:</p> <ul data-bbox="436 1252 1012 1284" style="list-style-type: none"> <li data-bbox="436 1252 1012 1284">• Make sure DHCP is enabled for the router.
	<p data-bbox="403 1292 985 1380">Inverters with retrofitted Piggy-Back shut down overnight. Therefore, it is not possible to establish any connection to these inverters.</p> <p data-bbox="403 1388 974 1447">As soon as the inverters switch on in the morning, they will be accessible again.</p>

Problem	Cause and corrective measures
Piggy-Back update does not initialize.	Inverter feed-in power is less than 50 W. Corrective measures: <ul style="list-style-type: none">• Only carry out update once inverter feed-in power is at least 50 W.

8.2 Performing a Piggy-Back Update

Piggy-Back updates are performed via Sunny Explorer. There is no need to replace the Piggy-Back. Existing inverter settings and data are retained after the update. Only carry out an update providing that inverter feed-in power is sufficient (at least 50 W). After a successful update, restart Sunny Explorer.

9 Technical Data

General Data

Mounting location	in the inverter
Voltage supply	via the inverter

Mechanical Data

Width x height x depth	2 in. x 3 1/4 in. x 1 5/32 in. (50 mm x 81 mm x 12 mm)
------------------------	---

Communication

Communication interface	Speedwire/Webconnect
Maximum cable length	328 ft. (100 m)

Ambient Conditions for Storage/Transport

Ambient temperature	- 40°F to +158°F (- 40°C to +70°C)
Relative humidity, non-condensing	5% to 95%
Maximum height above mean sea level	9,842 ft. (3,000 m)

10 Compliance Information

FCC Compliance

This device complies with Part 15 of the FCC Rules. Operation is subject to the following conditions:

1. This device may not cause harmful interference, and
2. This device must accept any interference received, including interference that may cause undesired operation.

NOTE: This equipment has been tested and found to comply with the limits for a Class B digital device, pursuant to Part 15 of the FCC Rules. These limits are designed to provide reasonable protection against harmful interference in a residential installation. This equipment generates, uses, and can radiate radio frequency energy and if not installed and used in accordance with the instructions, may cause harmful interference to radio communications. However, there is no guarantee that interference will not occur in a particular installation. If this equipment does cause harmful interference to radio or television reception, which can be determined by turning the equipment off and on, the user is encouraged to try to correct the interference by one or more of the following measures:

- Reorient or relocate the receiving antenna.
- Increase the separation between the equipment and the receiver.
- Connect the equipment into an outlet on a circuit different from that to which the receiver is connected.
- Consult the dealer or an experienced radio/TV technician for help.

The user is cautioned that changes or modifications not expressly approved by SMA America, LLC could void the user's authority to operate this equipment.

IC Compliance

This Class B digital apparatus complies with Canadian ICES-003.

Cet appareil numérique de la classe B est conforme à la norme NMB-003 du Canada.

11 Contact

If you have technical problems concerning our products, contact the SMA Service Line. We require the following information in order to provide you with the necessary assistance:

- Inverters:
 - Type
 - Serial number
 - Firmware version
- Piggy-Back
 - Type
 - Serial number
 - Firmware version
- Large-scale PV power plants:
 - Serial number and firmware version of the Cluster Controller
- Small-scale PV plants:
 - Name of your Sunny Portal plant
 - PIC and RID of the Piggy-Back

United States/ Estados Unidos	SMA America, LLC Rocklin, CA	+1 877-MY-SMATech (+1 877-697-6283)* +1 916 625-0870**
Canada/ Canadá	SMA Canada, Inc. Toronto	+1 877-MY-SMATech (+1 877-697-6283)***

* toll free for USA, Canada and Puerto Rico / Llamada gratuita en EE. UU., Canadá y Puerto Rico

** international / internacional

*** toll free for Canada / gratuit pour le Canada

SMA Solar Technology

www.SMA-Solar.com

 **Soligent** YOUR dJ™ DISTRIBUTOR
SOLIGENT
800-967-6917
www.soligent.net

