



**ProHarvest PRO208-5k75  
(HiQ TS208-5k75)  
Inverter System  
Installation & Safety Manual**





## ProHarvest Contact Information

Address: Corporate Headquarters  
17825 – 59<sup>th</sup> Avenue N.E.  
Suite B  
Arlington, WA 98223 USA

Telephone: +1.360.435.6030  
+1.360.618.4363 (Technical Support)  
+1.360.435.6019 (Fax)

Email: Support@outbackpower.com

Website: <http://www.outbackpower.com>

## Disclaimer

PROHARVEST BY OUTBACK POWER:

(a) MAKES NO WARRANTY AS TO THE ACCURACY, SUFFICIENCY OR SUITABILITY OF ANY TECHNICAL OR OTHER INFORMATION PROVIDED IN ITS MANUALS OR OTHER DOCUMENTATION. (b) ASSUMES NO RESPONSIBILITY OR LIABILITY FOR LOSS OR DAMAGE, WHETHER DIRECT, INDIRECT, CONSEQUENTIAL OR INCIDENTAL, WHICH MIGHT ARISE OUT OF THE USE OF SUCH INFORMATION. THE USE OF ANY SUCH INFORMATION WILL BE ENTIRELY AT THE USER’S RISK. (c) RESERVES THE RIGHT TO MAKE CHANGES TO THE PRODUCTS AND INFORMATION CONTAINED IN THIS DOCUMENT WITHOUT NOTICE.

## Notice of Copyright

ProHarvest PRO208-5k75 Inverter System Installation & Safety Manual ©2016 OutBack Power Technologies. All Rights Reserved.

## Trademarks

ProHarvest, the ProHarvest logo, the phrase “ProHarvest by Outback Power”, and OutBack Power are trademarks owned and used by OutBack Power Technologies, Inc. HiQ, the HiQ logo, and TrueString are trademarks owned and used by HiQ Solar, Inc. These trademarks may be registered in the United States and other countries.

## Date and Revision

Revision A, September 2016

## Part Number

900-0203-01-00 Rev A

## Table of Contents

<b>1. Audience</b>	<b>5</b>
<b>2. Safety</b>	<b>5</b>
2.1. Symbols Used	5
2.2. General Safety Provisions, Warnings, and Precautions	6
<b>3. Introduction</b>	<b>7</b>
3.1. System Overview	7
3.1.1. <i>ProHarvest 208V Inverter</i>	8
3.1.2. <i>Communication Gateway</i>	8
<b>4. System Ordering &amp; Part Number Identification</b>	<b>9</b>
<b>5. Design Guidelines</b>	<b>11</b>
5.1. DC Stacking Ratio	11
5.2. Notes on Siting	11
5.2.1. <i>Inverter Placement</i>	12
5.2.2. <i>Gateway Placement</i>	12
5.3. Notes on Wiring	12
5.3.1. <i>AC Cable</i>	12
5.3.2. <i>Grounding</i>	13
5.3.3. <i>Neutral</i>	13
<b>6. Installation</b>	<b>13</b>
6.1. Cautions	13
6.2. Connection Outline	14
6.3. Basic Connection Procedure	14
6.4. More Detailed Installation Information	18
6.4.1. <i>Meanings of Buttons &amp; Indicators</i>	18
6.4.2. <i>Manufacturing Date</i>	19
6.5. Gateway Information	20
6.5.1. <i>The Memory Card</i>	20
6.5.2. <i>Methods of Accessing System Information</i>	20
6.5.3. <i>Registering Inverters</i>	21
6.5.4. <i>Gateway Touch Screen Menu Structure</i>	23
6.5.5. <i>Gateway Web Page Menu Structure</i>	24
6.5.6. <i>Arc Detection</i>	26
6.5.7. <i>Utility Protective Function – Adjustable Limits</i>	27
6.5.8. <i>System Firmware Updates</i>	28
6.5.9. <i>Gateway Access Inside a Local Network</i>	29
6.5.10. <i>Accessing the Gateway from Outside the Local Network – LAN-side configuration</i>	30
6.5.11. <i>Accessing the Gateway from Outside the Local Network – WAN-side configuration</i>	32

<b>7. Troubleshooting</b>	<b>34</b>
7.1. Overview of Possible Issues	34
7.2. If I had this issue, it would look like these symptoms	35
7.3. If I had these symptoms, it could be one of these causes	36
7.4. Notes on Selected Issues	37
7.4.1. Inverter Button Indicator States	37
(A) Internet Connectivity Issues	38
(B) Gateway Memory Card Issues	39
(C) Gateway to Inverter Connectivity Issues	39
(D) AC Wiring Issues	40
(E) Inverter Installation Issues	41
(F) PV Module Wiring Issues	41
<b>8. Specifications</b>	<b>41</b>
8.1. Power System Specifications	41
8.2. Communications Gateway Specifications	43
8.3. Unit Rating Label	44
8.4. System UL 1741 Certificate	45
8.5. Physical Dimensions & Drilling Guides	46
8.5.1. ProHarvest 208V Inverter	46
8.5.2. Gateway	47

## 1. Audience

These instructions are for use by qualified electricians or other personnel. Qualified personnel must meet all local and governmental code requirements for licensing and training for the installation of three-phase electrical power systems with AC and DC voltage up to 1000 volts. They must also be familiar with communication networks. This will require knowledge of acquiring real-time and historical data via computers and other external devices.

## 2. Safety



*IMPORTANT SAFETY INSTRUCTIONS – Please read*

### *SAVE THESE INSTRUCTIONS*



This manual contains important safety instructions for the ProHarvest 208V inverter system, composed of inverter model PRO208V-5k75 and the Communications Gateway. These instructions shall be followed during installation and maintenance of the inverter system. The inverter system is designed according to North America safety requirements. As with any electrical equipment, certain precautions must be observed when installing this equipment. To reduce the risk of personal injury and to ensure safe installation and operation, carefully read and follow all instructions, cautions and warnings in this Installation Manual.

### 2.1. Symbols Used

The following symbols describe situations or procedures or practices which if not correctly performed or followed could result in damage or destruction of the described equipment or other components attached to the described equipment, or personal injury.

Symbol	Description
	<b>CAUTION: Hazard to Equipment</b> This type of notation indicates that the hazard may cause damage to the equipment.
	<b>NOTE:</b> This type of notation indicates that the information provided is important to understanding the operation and limits of the equipment. Failure to follow the recommendations in such a notation could result in improper or failed operation.

The following symbols are used as markings on this product with the following explanations:

Symbol	Description
	<b>WARNING — DANGEROUS VOLTAGE</b> This product incorporates high voltages. All handling of and operation of this product should closely follow the instructions included.
	<b>CAUTION — BEWARE OF HOT SURFACE</b> This product may become hot during operation. Contact should be avoided.

## 2.2. General Safety Provisions, Warnings, and Precautions

- Connection of the system must be to 208V nominal, 3-phase AC only.
- The ProHarvest 208V inverter is provided with DC circuit protection in accordance with the requirements for ungrounded systems as outlined in NEC 690.35(C).
- These systems meet the requirements of NEC 690.11 for DC arc-fault protection.
- All electrical installations must be performed in accordance with all applicable local, state and national requirements, including ANSI/NFPA 70.
- Inverters must be provided with an equipment ground per NEC 690.43.
- All 5 circuits (L1, L2, L3, Neutral, Ground) must be connected and Neutral must be bonded to earth ground. Failure to do so can damage the unit and void the warranty.
- The inverter components contain no user-serviceable parts. For all repair and maintenance always contact your authorized dealer or installation partner.
- The ProHarvest 208V inverter has inputs for two separate DC strings. Reversal of polarity of one or both string inputs will irreparably damage the unit.
- The inverter system is a utility-interactive system. Before connecting any solar power system to the grid contact your local utility company. This connection should only be made by qualified personnel.
- PV arrays produce voltages that can present an electrical shock hazard. Wiring of PV arrays should be performed by qualified personnel following all manufacturer's guidelines.
- Be aware that the body of the inverter acts as a heat sink. Under normal operating conditions, the temperature of the exterior of the enclosure can reach more than 15 °C above ambient. Under extreme conditions the exterior of the enclosures can reach a temperature of 80 °C. To reduce risk of burns, use caution when working with the inverter system.
- Communication Gateway AC Connection Procedures
  - To connect: Plug the AC cable into the Gateway FIRST, then plug the other end into the wall outlet.
  - To disconnect: Unplug the cable from the AC wall outlet FIRST, then proceed to disconnect the cable from the Gateway device.
- In order to maintain the integrity of the watertight enclosures, all connectors must be properly and fully engaged.
- Before installation, carefully read all instructions, cautions, and warnings in this manual.

### 3. Introduction

This instruction manual covers the ProHarvest 208V inverter system. A summary of features and functions is shown in the table.

Item	Inverter
Grid voltage	208V, Wye configuration
Nominal power	5.75 kW
Maximum Power Point Tracking, MPPT	Per individual string
Monitoring	Per individual string
NEMA6, waterproof	✓
Arc detection	✓
Hand-holdable	24 lb.
Mounting orientation	Any
No electrolytic capacitors	✓

#### 3.1. System Overview

A typical layout is shown in Figure 1. Note that while the Communications Gateway provides detailed reporting and user control, it is optional — the system will generate power without it.

Each of the ProHarvest 208V systems is an easy to install, modular system optimized specifically for commercial rooftop ungrounded solar array applications. Unlike other string inverters, each string is individually monitored and managed by the inverter.

The main components of the inverter system are described in the next section.

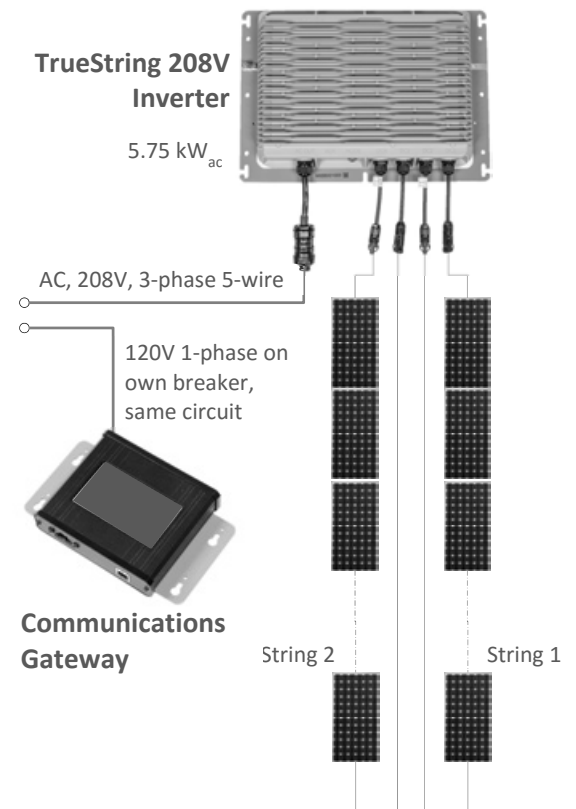

**Figure 1: System overview showing two strings of PV modules supplying a single 208V inverter. A Communication Gateway is shown connected to one 120V phase.**

### 3.1.1. ProHarvest 208V Inverter

One inverter connects to up to 2 strings of PV modules, and in turn to the installation site 3-phase, 208V compatible utility connection. The 208V inverter is shown in Figure 2. It is a non-isolated inverter for use with ungrounded DC systems.



Figure 2:  
208V Inverter

	<p><b>NOTE:</b> Multiple inverter outputs may be connected in parallel by a qualified electrician.</p>
---	--

### 3.1.2. Communication Gateway

One Gateway module connects to a 120V/60Hz branch that is connected to the same 3-phase, 208V compatible utility connection supplied by the inverter(s). The Gateway module provides for system monitoring, logging and control. The Gateway Module is shown in Figure 3 and is designed for indoor use only.



Figure 3:  
Communications  
Gateway





## 4. System Ordering & Part Number Identification

A typical 5.75 kW unit consists of:





- 1 ProHarvest 208V inverter
- 1 Communication Gateway which can be used with multiple inverters.

Ordering may be accomplished using the following part numbers.

Inverter and accessories:

Item	Part Number	Description
Inverter, 5.75 kW, 208V 3-phase 	ProHarvest: PRO208-5k75 (HiQ: TS208-5k75)	Inverter with MC4-compatible connectors (1ea). MPPT per string, monitoring per string. Includes 10-year limited warranty. Does not include Gateway. Does not include AC cable; must be ordered separately.
Inverter, 5.75 kW, 208V 3-phase with RS485 communication and Aux connector	ProHarvest: PRO208-5k75-AUX (HiQ: TS208-5k75-AUX)	Inverter with MC4-compatible connectors (1ea). MPPT per string, monitoring per string, RS485 communication and Aux connector. Includes 10-year limited warranty. Does not include Gateway. Does not include AC cable; must be ordered separately.
System Warranty Extension to 25 years for 1 ProHarvest 208V inverter	ProHarvest: PRO208-5k75-W25 (HiQ: TS208-5k75-W25)	Must be ordered at time of system purchase. Includes system Gateway(s).
208V inverter AC Cable 	CBL-208A-05	5 ft. Includes 208V AC mating connector; other end is unterminated.
	CBL-208A-15	15 ft. Includes 208V AC mating connector; other end is unterminated.
	CBL-208A-30	30 ft. Includes 208V AC mating connector; other end is unterminated.
	CBL-208A-50	50 ft. Includes 208V AC mating connector; other end is unterminated.
Connector Tool Kit 	TOOL-KIT-1	AC Connector Unlatching Tool (1ea). MC4-Compatible Connector Unlatching Tool (1ea).

Communications Gateway:

Item	Part Number	Description
<p>Communications Gateway</p> 	<p>ProHarvest: PROGW-A-120 (HiQ: GW-A-120)</p>	<p>GW-A Communication Gateway 120V (1ea). Includes Ethernet Cable (1ea), memory card for logging and storage of results, and 120V power cable.</p>
<p>Memory Card</p> 	<p>MCRD-A</p>	<p>Storage for Gateway results. Generic SD card — makes and capacities supplied will vary.</p>
<p>Gateway Ethernet Cable</p> 	<p>CBL-RJ45-6</p>	<p>RJ45 8P8C plug each end. Color etc. may vary.</p>
<p>Gateway AC Cable</p> 	<p>CBL-GW120A-6</p>	<p>Gateway 120V AC Cable with AC Plug.</p>

## 5. Design Guidelines

### 5.1. DC Stacking Ratio

The ratio of PV module STC power rating to inverter output power rating is often referred to as “Stacking Ratio.” Most PV installations are designed for a stacking ratio greater than 1, and less than 1.5. However, the only real limitation on stacking ratio for the inverter is the voltage and current limitations of the string inputs. The full power  $V_{mp}$  range for the string inputs is 325 to 525  $V_{DC}$ . The specified maximum short circuit current of the DC source is 30A. Two strings with a  $V_{mp}$  of 525  $V_{DC}$  and a short circuit current capability of 30A would yield a stacking ratio of almost 8.9.

A more practical limitation is due to the power and current limits imposed by the inverter firmware. Input power is limited to 3kW and input current is limited to 10A per string by the firmware. The total of these two strings exceeds the output power limit of 5.75kW, so in reality something less than 3kW would be harvested from each string.

Ideal stacking ratio varies by installation. For the vast majority of installations, a stacking ratio between 1.25 and 1.5 makes perfect sense. Under some conditions (constant high irradiance) a lower stacking ratio may be preferred. A stacking ratio of 1.1 to 1.25 typically allows for energy harvest loss factors such as less than ideal module orientation, inverter efficiency losses, module soiling, module aging, etc. Nevertheless in some cases a stacking ratio of 1.5 or greater can be advantageous. For example in the northern hemisphere a North facing array, or an East or West-facing array may justify a higher stacking ratio.

The system designer is responsible for specifying the string parameters to remain within the inverter ratings.

### 5.2. Notes on Siting

The ProHarvest 208V is suitable for flat, commercial rooftops, carports, ground mounts, and other commercial installations. It may be placed using the self-ballasting metal casing, or alternatively may be attached to a PV module frame or roofing component using the provided attachment mechanisms.

A line diagram is shown in Figure 4. Note that the inverter requires a 208V Wye grid configuration.

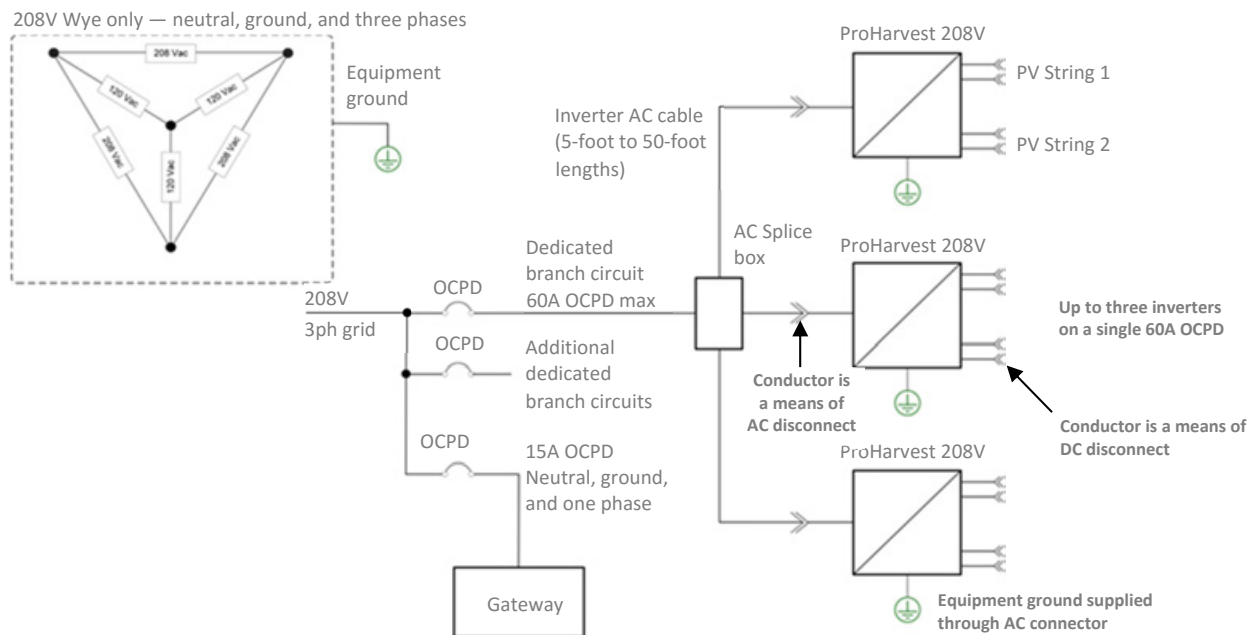

**Figure 4: Example line diagram**

- Note that up to 3 inverters may be connected on the same branch to one 60A OCPD if desired.
- A NEMA4 AC Splice junction box is available for use with 3 208V inverters if desired.

The following sections provide details on individual component placement guidelines and requirements.

### 5.2.1. Inverter Placement

The ProHarvest 208V inverter is NEMA6 rated and may be placed almost anywhere. Cooling is most efficient if the unit is mounted vertically in the shade, bolted to racking and with the connectors pointing downwards. However, any orientation is acceptable.



Figure 5: Ideal placement of the 208V inverter

Mounting hardware up to 5/16" will fit the baseplate mounting slots.

### 5.2.2. Gateway Placement

- The Gateway is rated for indoor installation only. Do not expose it to rain, extreme temperatures, or excessive dust. It must be mounted indoors. A utility closet or similar location physically close to the inverter system is ideal. It must be electrically connected to one of the three phases that are connected to the inverter. Note that in large utility closets it is often easy to end up on an unrelated AC circuit accidentally, in which case communications are unlikely to be successful.



**CAUTION: Hazard to Equipment**

The Gateway Device is not rated for outdoor installation.

- Recommended: Add a 120 V<sub>ac</sub> outlet at the earliest entry point in the building to provide the best power line communication (PLC) signal possible. Ideally this would be a 120 V<sub>ac</sub> outlet next to the circuit breaker.
- Gateway should be protected by a 15A OCPD.
- A wired Ethernet network connection must be provided to the Gateway for proper data retrieval.
- If outdoor placement is required, the Gateway must be housed in a weatherproof enclosure.
- The Gateway has 'keyhole' mountings on its baseplate. Each hole has a guide-hole above — it is intended that these four holes provide a template for mounting such that a pen or center punch can be inserted through and marks left on the wall to help accurate drilling of holes. Mounting can be achieved using #8-sized screws.



Figure 6: Gateway baseplate showing keyhole mounting and drilling guide hole.

## 5.3. Notes on Wiring

### 5.3.1. AC Cable

The inverter AC cable has a TC-ER rating. The “-ER” signifies that the cable is sufficiently rugged to permit its use as exposed wiring, according to the NEC (section 336.10). Exposed wiring is wiring that is not installed in a tray, conduit or other raceway. It must be secured every 6 feet or less, and protected from physical damage.

### 5.3.2. Grounding

The metal enclosure of the inverter must be grounded per NEC 690.43. Equipment ground is provided through the AC connection. Optionally, grounding may be achieved also through attaching an Equipment Ground Conductor (EGC) to a lay-in lug (not provided) attached to the chassis as shown in Figure 7.

Grounding may also be achieved using the mounting bolts to any properly grounded metallic structure provided a paint-cutting washer is employed, such as a stainless steel star washer.



Figure 7: Example ground lug

### 5.3.3. Neutral

All 5 circuits (L1, L2, L3, Neutral, Ground) must be connected and Neutral must be bonded to earth ground. Failure to do so can damage the unit and void the warranty. Note that particular care is required to ensure that an effective neutral is maintained when a transformer forms part of the installation.



The inverter exports power only on the Line conductors. The neutral conductor is used solely for voltage sensing and power line communications.

## 6. Installation

The ProHarvest 208V inverter employs industry standard connection methods. These include locking interconnects for solar module attachment, and standard 5-lead, 3-phase AC wiring compatibility. Careful adherence to these instructions is required.

### 6.1. Cautions

Make certain to follow all instructions.

	<p><b>CAUTION: Hazard to Equipment</b></p> <ul style="list-style-type: none"> <li>• The system must be connected to 208V 3-phase Wye 5-wire only.</li> <li>• The inverter must be provided with an equipment ground per NEC 690.43.</li> <li>• All five circuits (L1, L2, L3, Neutral, Ground) must be connected and Neutral must be bonded to earth ground. Failure to do so can damage the unit and void the warranty.</li> <li>• The ProHarvest 208V inverter has inputs for two separate DC strings. Reversal of polarity of one or both string inputs will irreparably damage the unit. Use a voltmeter to carefully verify that the DC inputs are correct before connecting to the inverter DC inputs.</li> <li>• The Communications Gateway is for indoor use only.</li> <li>• In order to maintain the integrity of the watertight enclosures:             <ul style="list-style-type: none"> <li>○ All connectors must be properly and fully engaged.</li> <li>○ Unused connectors must be sealed using appropriate weatherproof caps.</li> </ul> </li> <li>• Do not allow water to enter the AC or DC connectors or warranty will be void.</li> </ul>
	<p><b>WARNING: Shock Hazard</b></p> <p>Before disconnecting DC cables, use a current clamp meter to measure the presence of current. If current is present, cover the portion of the array affected, per NEC 690.18.</p>

## 6.2. Connection Outline

Connection occurs in the following order:

1. Connect an equipment ground to the inverter. This should always be done first.
2. Connect the inverter to the grid.
3. Connect the Communication Gateway to the same 208V circuit as the inverter and the network.
4. Lastly, connect the PV module strings to the inverter inputs.

Disconnection uses these steps in reverse, with system ground being the last item to be disconnected.

## 6.3. Basic Connection Procedure

1. Ground the inverter.

The inverters must be grounded.

Equipment ground is provided through the AC connection. Optionally, a grounding lay-in lug (not supplied) may be used (Figure 8), or the mounting method may be used if employing a paint-cutting washer such as a stainless steel star washer.



Figure 8: Example ground lug

2. Connect the inverter to the grid

**(a) Connect the inverter to the AC system** in the usual way using the AC cable (supplied separately) — see Figure 9.

This should only be carried out by qualified personnel.

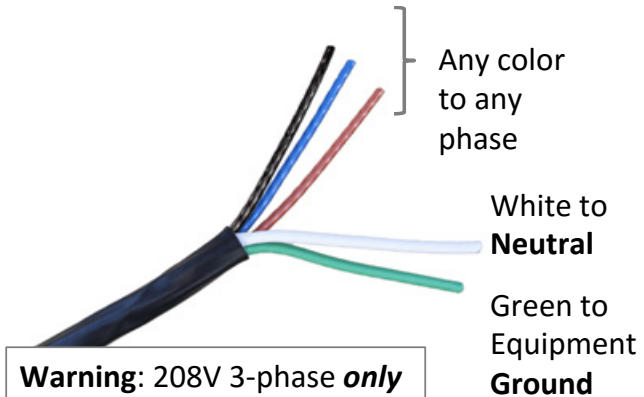



Figure 9: Wiring identification on the inverter AC cable

	<p><b>NOTES</b></p> <ul style="list-style-type: none"> <li>• The unit is only watertight when connectors are fully engaged.</li> <li>• The inverter AC cables are TC-ER rated<sup>1</sup>.</li> </ul>
	<p><b>WARNING: Dangerous Voltage</b></p> <p>This product incorporates high voltages.</p>

<sup>1</sup> The “-ER” signifies that the cable is sufficiently rugged to permit its use as exposed wiring, by the National Electrical Code. Exposed wiring is wiring that is not installed in a tray, conduit or other raceway.

(b) Mate the male and female AC connector to connect the inverter to the AC system. The AC remains off.

Use the AC tool to disconnect the male and female connectors. Follow steps 1 through 3 in the Disconnection section of Figure 10.

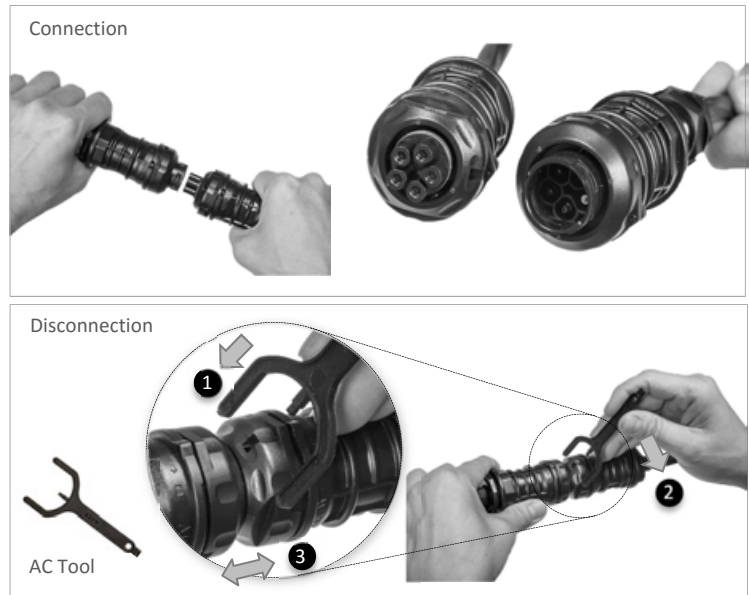

**Figure 10: Connecting and disconnecting of the inverter AC connection**

3. Connect the Communications Gateway.

	<p><b>CAUTION: Hazard to Equipment</b></p> <p>The Gateway Device is rated for indoor installation only.</p>
---	---

(a) The Gateway should be **sited indoors**, as near to the inverter(s) as possible for reliable communications (Figure 11).

**Figure 11: Wiring of the Communication Gateway**

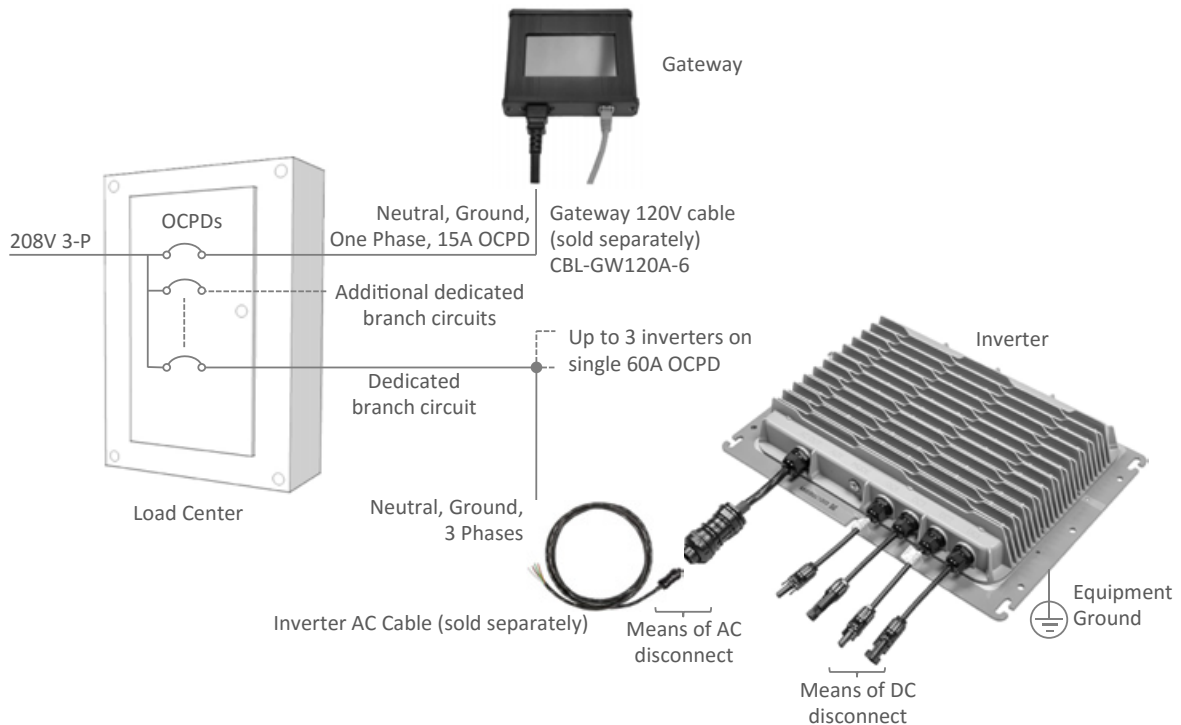



(b) Connect power to the Gateway using the appropriate AC cable (Figure 12). Ethernet may also be connected at this stage.

**Figure 12: Making Gateway connections**

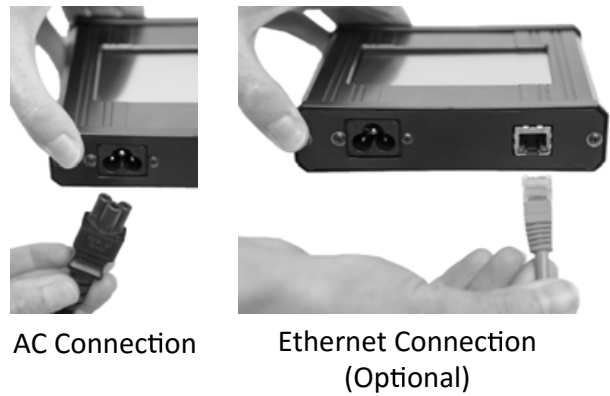

(c) Switch on power to the inverter. On the Gateway screen, press the 'Inverters' button at the top of the screen if the unit is not already on that tab. Press the 'Discover' button.

The Gateway will search for any/all inverters and check that they indicate Healthy.

Note that new inverters arrive in the "Off and Locked" state. (See Table 2 on page 19 for the LED indication of this state.) They will not generate until told to do so.



**Figure 13: Having the Gateway auto-discover added inverters**

4. Connect the strings of PV modules.

It is recommended that the AC be switched off before doing this.

- Do not reverse the polarity of the DC inputs — irreparable damage will be caused to the inverter.
- All connectors must be fully mated to ensure weatherproofing.

Use the DC tool to disconnect the male and female connectors. Follow steps 1 and 2 in the Disconnection section of Figure 14.

With the AC off but DC string voltage present, the inverter button will flash red and emit a short audible beep, indicating a fault. (See Table 2 on page 19.) This is normal when no grid is present.

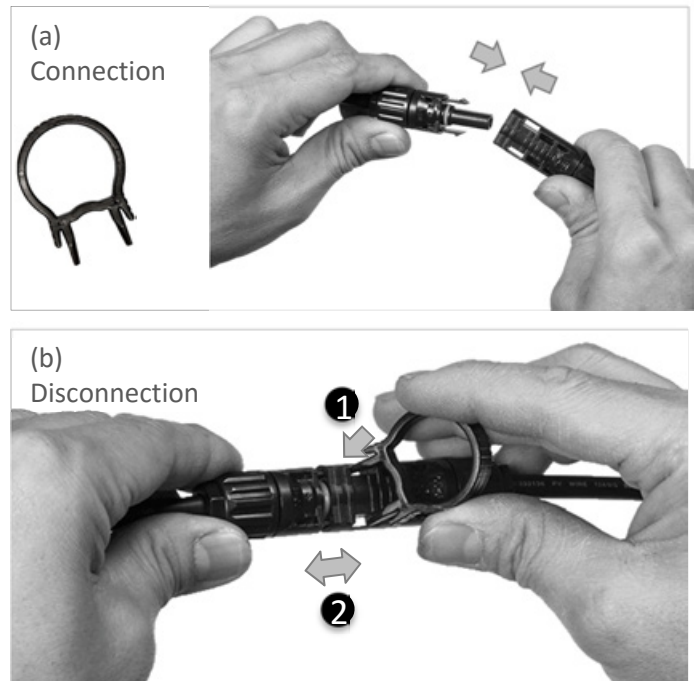

**Figure 14: Connecting and disconnecting MC4-compatible module connectors**



5. Switch on the AC.

The inverter buttons will show that the system is still “off & locked”. (See Table 2 on page 19.)

Inverters may be controlled individually or all together. To turn all on together, go to the ‘Array’ screen.

“Off + Unlock” will unlock all inverters in the array. This starts a 5 minute timer, after which the inverters will each do a self-test, then start generating. During the wait period, the button will be solid green.

To skip the 5 minute wait, press “Power On” — the units will self-test and then start generating. (See Table 2 on page 19 for the LED indications of self-test.)

Once self-test has been successfully completed, power generation begins.

For individual inverters, check the Gateway ‘Panels’ screen to verify all items indicate Healthy.

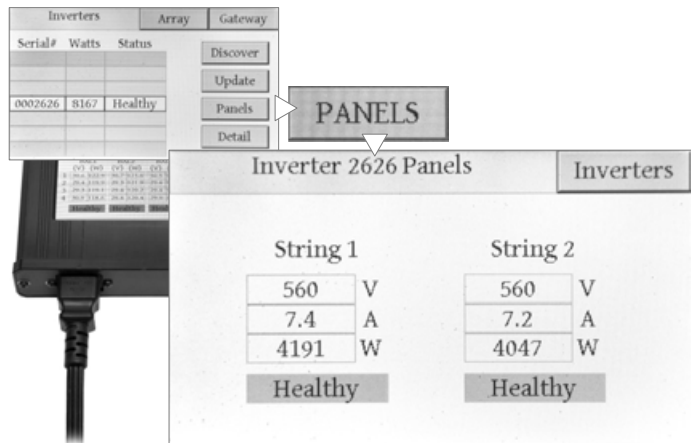















Figure 15: Verifying that all modules are healthy using the Gateway

## 6.4. More Detailed Installation Information





### 6.4.1. Meanings of Buttons & Indicators

While most installations will use a Communication Gateway to control and report, it is not mandatory — the inverter can be controlled using the button, as illustrated in Table 1. A brief press-and-release of the button counts as a button-push in the guide below. Indications given by the button illumination are shown in Table 2.

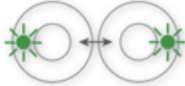

Inverter Button Push	Button Indication	Result
1 press 		<ul style="list-style-type: none"> <li>• Make inverter beep (“are you alive?”)</li> </ul>
2 presses 		<ul style="list-style-type: none"> <li>• ‘Off &amp; Locked’ - disabled</li> <li>• Do not 5-minute self-start</li> </ul>
3 presses 		<ul style="list-style-type: none"> <li>• Start generating immediately</li> <li>• If locked, unlock &amp; generate immediately</li> <li>• (If system is faulted, will unlock but won’t generate)</li> </ul>
Long press (>2 seconds) 	 (Brief flash)	<ul style="list-style-type: none"> <li>• Alternate functions mode, ready to accept further button pushes. Times out after 10 seconds</li> </ul>
1 press (after long press) 		<ul style="list-style-type: none"> <li>• Clear latched faults, for example after RCD or arc-fault test has initiated a fault condition</li> </ul>
3 presses (after long press) 		<ul style="list-style-type: none"> <li>• RCD-test activation. Successful operation of RCD test should cause a fault condition (rapid red flashing) until cleared</li> </ul>
4 presses (after long press) 		<ul style="list-style-type: none"> <li>• Arc-fault test activation. Successful operation of arc-fault detection should cause a fault condition (rapid red flashing) until cleared</li> </ul>

**Table 1: Inverter pushbutton actions and results**

Inverter Indicator State	Meaning
 Solid	<ul style="list-style-type: none"> <li>Powered up</li> <li>Not generating</li> <li>No faults</li> </ul>
 Left-right flash	<ul style="list-style-type: none"> <li>Power-on self-test (will take &lt;1 minute)</li> </ul>
 Green Chaser	<ul style="list-style-type: none"> <li>Powered up</li> <li>Generating, no faults</li> </ul>
 Rapid Flash	<ul style="list-style-type: none"> <li>Faulted, e.g. arc detected</li> </ul>
 Mostly On	<ul style="list-style-type: none"> <li>'Off &amp; Locked' - disabled</li> </ul>
 Mostly Off	<ul style="list-style-type: none"> <li>Sleeping – not generating</li> </ul>

**Table 2: Inverter indicator states and meanings**

### 6.4.2. Manufacturing Date

The inverter and Gateway each have an individualized serial number label, with an example shown in Figure 16. The first 4 letters are for device model code; this is followed by the 6-digit serial number (for example 001003). The manufacturing date code is available in the QR code, readable with common smartphone applications. The QR code will give the same information, appended with the date of manufacture, for example TSEA001003 1341, where 13 is the year (2013), and 41 the calendar week number.

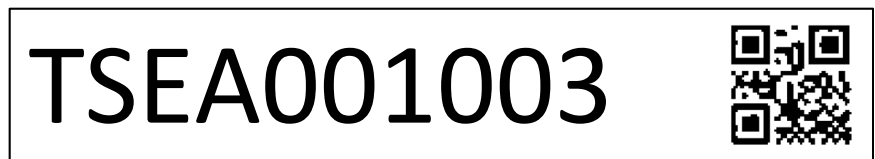

**Figure 16: Example serial number label with QR code containing the manufacturing date**

## 6.5. Gateway Information

This section covers common tasks and features associated with the Gateway.

### 6.5.1. The Memory Card

The Gateway is supplied with a memory card to allow long-term storage and retrieval of performance history. Care should be taken to ensure that it is fully inserted, as some functions are not available with the card not fully engaged. The card is pre-formatted with the FAT32 file system and is ready to be inserted into the Gateway as shown in Figure 17.

**Figure 17: Insertion of the memory card**



### 6.5.2. Methods of Accessing System Information

An overview of ways to access data is shown in Figure 18. The Gateway gathers data from inverters over a connected power line. The Gateway displays information on its touchscreen. With a suitable Ethernet network connection, it is capable of acting as a webserver, allowing a local computer or a remote computer with firewall access to see system performance as it is happening, displayed on a web page. Data is also transferred to servers to gather history, which can be accessed remotely. More details are given below.

**Figure 18: Methods of accessing data from inverters**

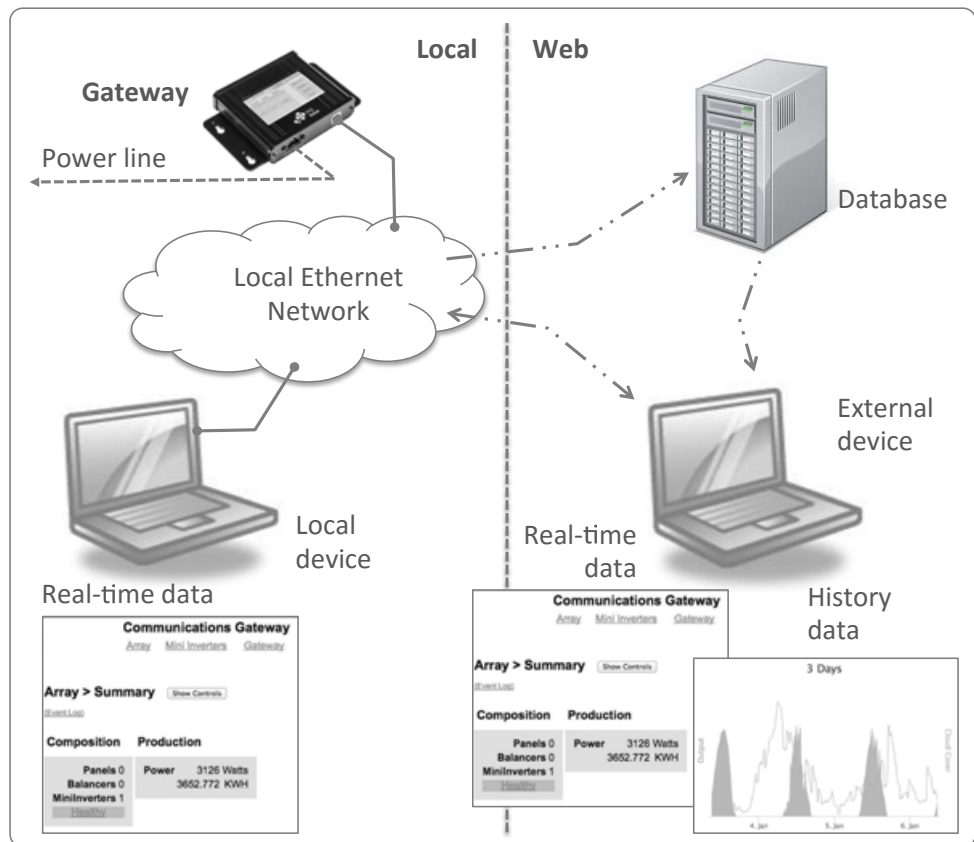

### 6.5.3. Registering Inverters

The Communication Gateway is intelligent, and when required to discover ProHarvest inverters nearby will do so easily with just the press of a button. Occasionally it may be desirable to manually register inverters, and this is also easy to achieve. Both procedures are described below.

#### 6.5.3.1. Automatic Discovery of Inverters

On the [Inverters] tab the 'Discover' button will search for any inverters in the local area. In most cases this is all that will be required, with all available inverters appearing on the list shown on the screen in Figure 19.

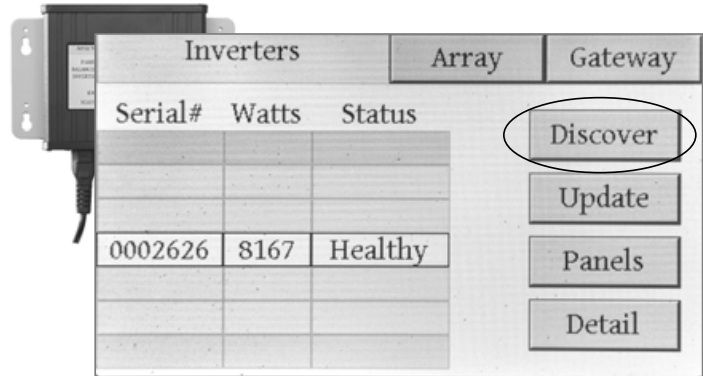

**Figure 19: States of the 'Discover' button with meanings**

Button State	Meaning
	<ul style="list-style-type: none"> <li>Initial state.</li> </ul>
	<ul style="list-style-type: none"> <li>Once pressed, in process of discovering inverters. Will return to initial state with empty serial number list if no inverters found.</li> </ul>
	<ul style="list-style-type: none"> <li>Error found, for example signal strength is too low, too much background noise on circuit. Red color only clears when user re-tries &amp; the fault condition no longer applies.</li> </ul>
	<ul style="list-style-type: none"> <li>Once discovery has successfully occurred, button returns to original state.</li> </ul>

This may also be achieved from the web interface. See Figure 20 (c).

6.5.3.2. Manual Registration of Inverters

Manual registration is accomplished using the web interface, with the ability to add and delete inverters as desired. See Figure 20. This may be found under the top level of the [Mini Inverters] tab.

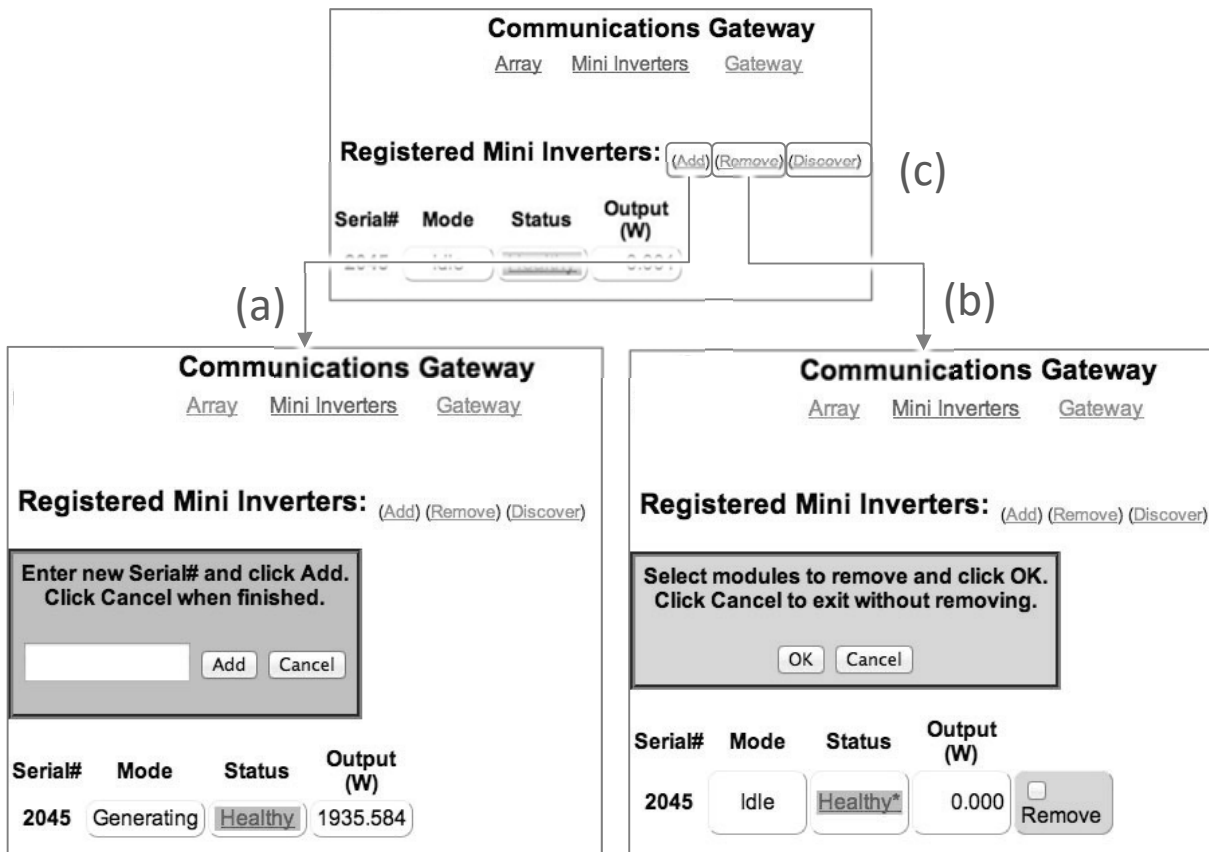

Figure 20: Adding and removing inverters manually using the web interface

### 6.5.4. Gateway Touch Screen Menu Structure

The following menu tree shows how different screens and functions are related and accessed.

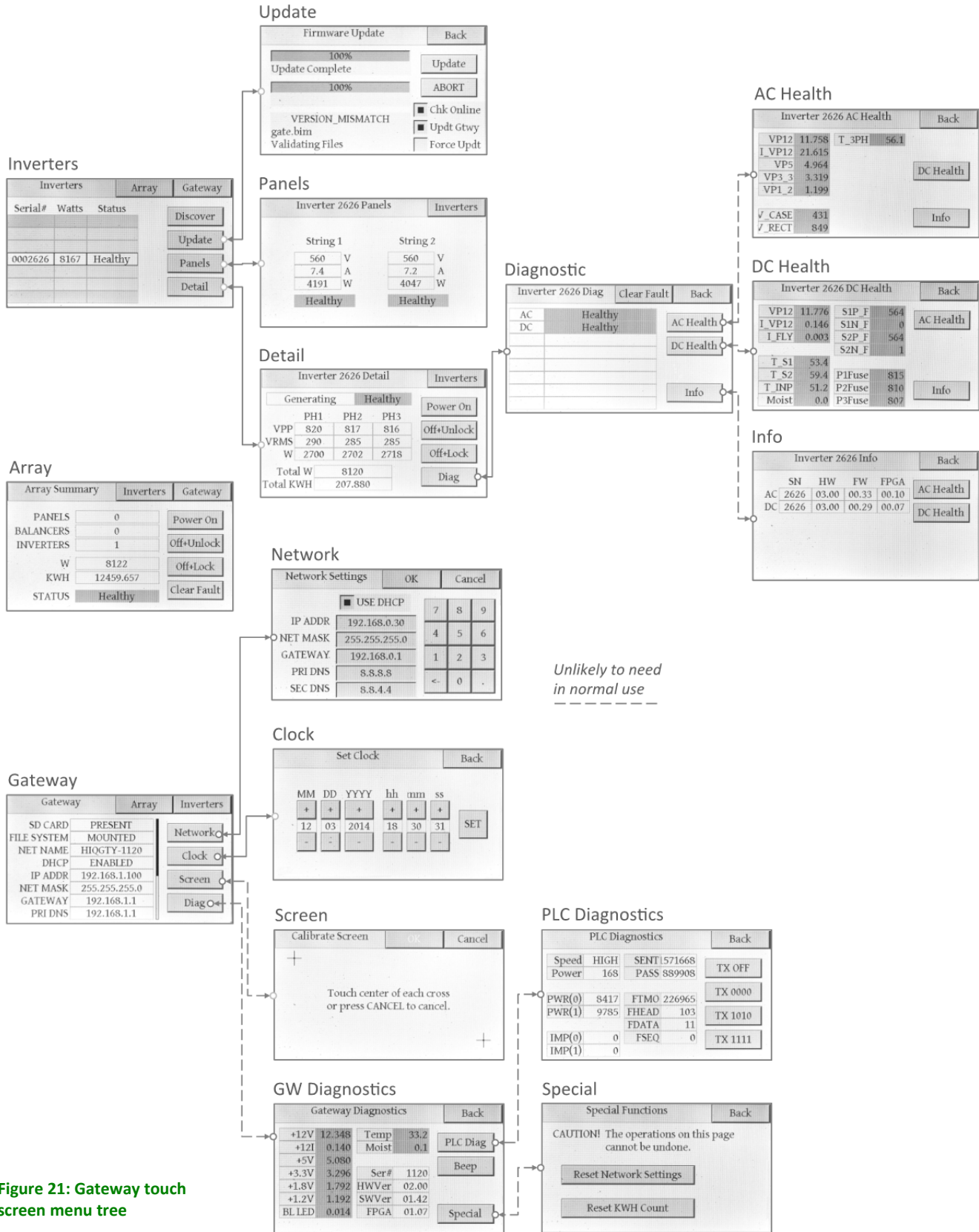

Figure 21: Gateway touch screen menu tree



6.5.5. Gateway Web Page Menu Structure

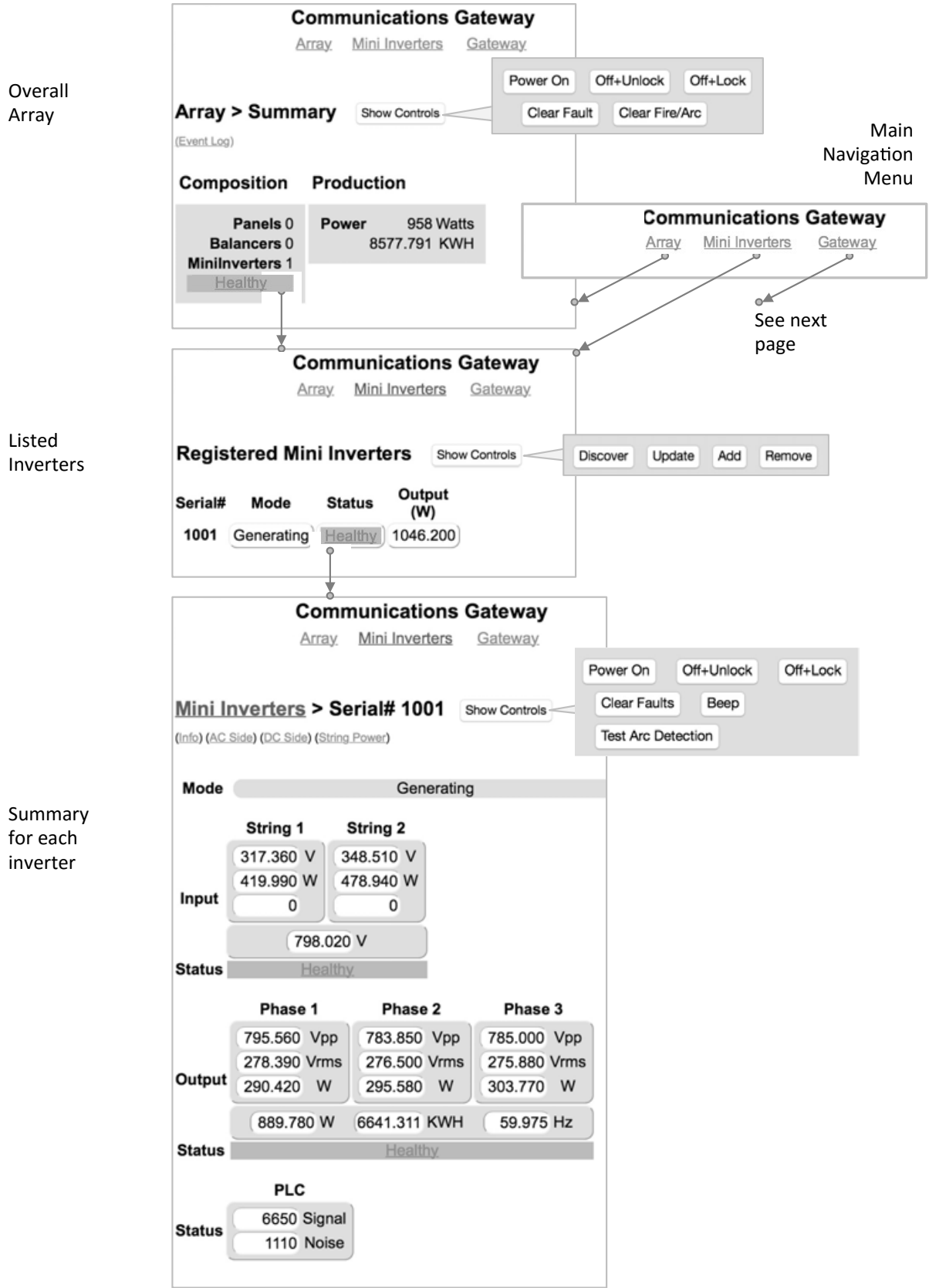

Figure 22: Array page and main inverter navigation



Gateway  
Summary  
Screen

**Communications Gateway**  
[Array](#) [Mini Inverters](#) [Gateway](#)

---

**Communications Gateway**  
[Array](#) [Mini Inverters](#) [Gateway](#)

**Network Settings**

<b>Name:</b> HIQGTY-1040	<b>HTTP Port:</b> 80
<b>DHCP:</b> ENABLED	<b>FTP Cmd Port:</b> 21
<b>IP Address:</b> 107.142.42.1	<b>FTP Data Port:</b> 8000
<b>Net Mask:</b> 255.255.255.248	<b>Diag Port:</b> 1000
<b>Gateway:</b> 107.142.42.6	
<b>Primary DNS:</b> 107.142.42.6	
<b>Secondary DNS:</b> 0.0.0.0	
<b>MAC Address:</b> 00:04:A3:51:FB:E5	

- [Change Network Settings](#)
- [Change Users and Permissions](#)

**Data Logging**

- [Upload Status](#)
- [Upload Settings](#)
- [Polling Intervals](#)
- [Clock Settings](#)

**File System**

- [File System Info](#)
- [FTP File Server](#)

**Gateway**

- [Auto-Update Settings](#)
- [Gateway Diagnostics](#)
- [PLC Statistics](#)
- [Diagnostic Log](#)

Figure 23: Gateway summary page (primarily for service use)

Show/Hide Webpage Controls

A valuable feature of the system is the ability to view and control the system from a smartphone when local computer network settings allow (see Section 6.5.9, page 29, below). Because phone screens are small it might sometimes be possible to accidentally activate or disable functions inadvertently. To help avoid this, the Gateway web page has a button for ‘Show Controls’ and ‘Hide Controls’ near the top of some of the screens. An example is shown in Figure 24.

Figure 24: Showing/hiding controls on the Gateway webpage

**Communications Gateway**  
[Array](#) [Mini Inverters](#) [Gateway](#)

---

**Array > Summary** [Show Controls](#)

↓

**Array > Summary** [Hide Controls](#)

[Power On](#) [Off+Unlock](#) [Off+Lock](#)

[Clear Fault](#) [Clear Fire/Arc](#)

### 6.5.6. Arc Detection

These products meet the requirements of NEC 690.11. If tripped, the inverter will shut itself down. It will also indicate with rapid red flashes of the button. The web page and Gateway will also show system fault flags (see Figure 25).

Note that power cycling of the system will not clear such a fault. It must be cleared using the procedure outlined in Figure 25, either using the Gateway touch screen or the web page.

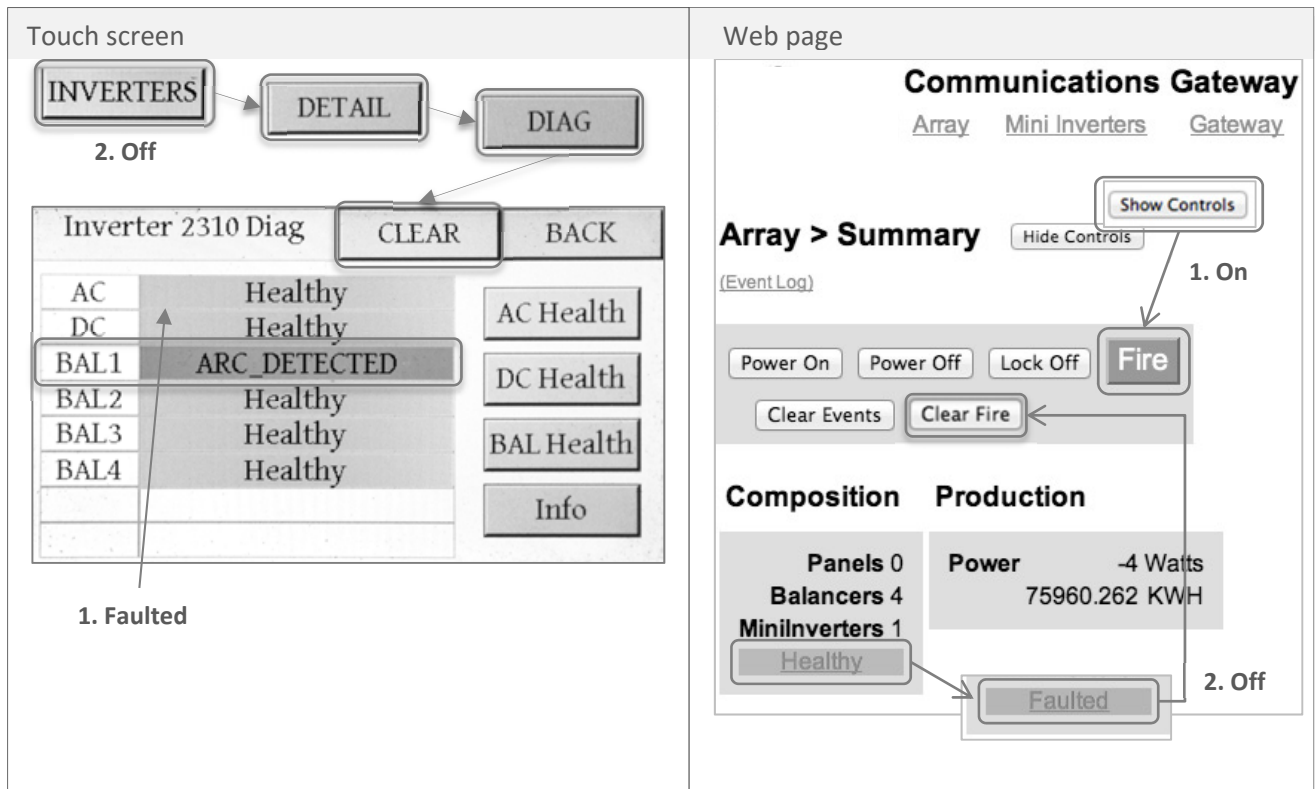

Figure 25: Arc fault indication and clearing procedures

### 6.5.7. Utility Protective Function – Adjustable Limits

The ProHarvest 208V inverter system is capable of operating beyond normal AC grid ranges when required to do so by the operating Utility Company. **Changes in this area must only be carried out with the express written permission of the Utility, only setting values specified by them.**

Changes are made through the web pages and cannot be accessed from the Gateway touchscreen. When logged into a particular Gateway through the web portal, type the following into the browser URL address bar after the serial number:

‘/SAFETYLIMITS.htm’ (capitalization is important here). An example is: <http://hiqgty-1020/SAFETYLIMITS.htm>.

This will bring up the screen shown in Figure 26. An individual serial number of an inverter on that Gateway is entered into the ‘Serial #’ field; pressing ‘Get’ will cause communication with the particular inverter and its current values will populate in the web page; when desired changes have been completed, ‘Set’ will write those values back to that same inverter.

Available ranges are given in the inverter Specifications table of Section 8.1 towards the end of this document.

**Figure 26: Utility protective adjustments dialog box**

**Communications Gateway**

[Array](#)   [Mini Inverters](#)   [Gateway](#)

---

**Inverter Safety Settings**

Serial #      

**Voltage Limits**

	VRMS	Cycles
<b>High</b>	<input type="text" value="305"/> <small>(305-315)</small>	<input type="text" value="120"/> <small>(60-1200)</small>
<b>Low</b>	<input type="text" value="245"/> <small>(220-245)</small>	<input type="text" value="120"/> <small>(60-1200)</small>

**Frequency Limits**

	Hz	Cycles
<b>High</b>	<input type="text" value="60.5"/> <small>(60.5-62.0)</small>	<input type="text" value="6"/> <small>(6-18000)</small>
<b>Low</b>	<input type="text" value="59.3"/> <small>(57.0-59.8)</small>	<input type="text" value="6"/> <small>(6-18000)</small>

Reset Time

- Cycles are the number of 60 Hz cycles after the limit is violated before the inverter turns off (Clearing Time)

### 6.5.8. System Firmware Updates

System firmware is occasionally updated to add features and enhance reliability even further. Firmware updates may be accomplished through a network connection or using a memory card physically inserted into the card slot on the Gateway. Updates may be controlled through the Gateway touchscreen or the Gateway webpage.

Touch screen	Web page
<p>The touch screen displays two sequential screens for a successful firmware update. The first screen shows 'Firmware Update' with a progress bar at 20% and the text 'Validating Files'. Below it, another progress bar is at 45% with the filename 'gatex.bim' and the message 'NO ERRORS'. On the right, there are buttons for 'UPDATE', 'ABORT', and three checkboxes: 'Chk Online', 'Updt Gtwy', and 'Force Updt'. The second screen shows the progress bar at 100% with the text 'Update Complete' and 'NO ERRORS'. The same 'UPDATE', 'ABORT', and checkbox options are present.</p>	<p>The web page interface for 'Communications Gateway' shows the 'Firmware Update' section. It includes navigation links for 'Array', 'Mini Inverters', and 'Gateway'. The main heading is 'Firmware Update'. Below it, a text box explains: 'Pressing <b>Update</b> will retrieve the latest firmware files from the web (if connected) then check and update each system in the list of Registered Mini Inverters.' This is followed by a bulleted list of notes:         <ul style="list-style-type: none"> <li>• Data collection will be suspended for the duration of the update.</li> <li>• If a particular Mini Inverter requires an update, it will be locked off for the duration of its update.</li> <li>• If the Gateway requires an update, it will reboot at the end of the update process.</li> </ul>         At the bottom, there are three checkboxes: 'Check online for latest version' (checked), 'Update Gateway, if needed' (checked), and 'Force update to released version' (unchecked). 'Abort' and 'Update' buttons are located at the very bottom.       </p>
<p>The touch screen displays the 'Firmware Update' screen with a progress bar at 1% and the text 'Retrieving Manifest'. Below it, another progress bar is at 0% with the same text 'Retrieving Manifest'. A red-bordered box highlights the error message 'COULD_NOT_GET_FILE'. The 'UPDATE', 'ABORT', and checkbox options are visible on the right.</p>	<p>The web page interface is identical to the previous one, showing the 'Firmware Update' section with the same instructions and options, but it does not show the error message.</p>

Example below where an update was initiated but the Gateway was unable to find a firmware file through the network connection or from the memory card.

### 6.5.9. Gateway Access Inside a Local Network

The following sections will probably be useful for the company IT department.

Note that the Gateway default is to be in DHCP mode — this is the easiest for local access inside a network.

#### 6.5.9.1. Accessing Locally from a Windows Device

1) Looking at the Gateway unit, use the touch screen to display the ‘Gateway’ tab. You may need to scroll to see the view below:

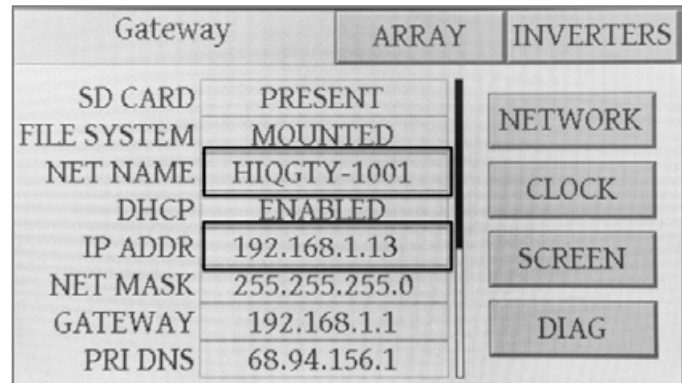

**Figure 27: Gateway screen showing the Net name and IP address**

2) Open a web browser. Either type into the address bar the ‘NET NAME’ (in our example ‘HIQGTY-1001’) or type in the listed IP address (here 192.168.1.13, but this will vary)<sup>2</sup>. This will bring up the web log in screen. Unless otherwise altered, the following will apply (case sensitive):

- Username: admin
- Password: HiQSolar

You will then see the home screen for that particular Gateway which should look like Figure 28:



**Figure 28: Web interface for the Gateway showing array statistics**

#### 6.5.9.2. Accessing Locally from a Mac OS Computer or Device Including iPads & iPhones

As above except ‘NET NAME’ is not supported — the IP address will need to be typed into the browser address line.

<sup>2</sup> Note that this IP address is for the web page the web server provides; the network connection the Gateway uses to communicate to a local router is the one further down the list labeled ‘Gateway’, 192.168.1.1 in this example.

### 6.5.10. Accessing the Gateway from Outside the Local Network — LAN-side configuration

DHCP has a lease time after which it requests renewal, problematic if it ends up with a different IP address. A method must be used to make the IP address stay fixed; this can be:

- i) Keep the Gateway in DHCP but force the router to allocate the same IP address each time. If this is supported by the router it is generally most desirable.
- ii) Change to a fixed IP address.

Router capabilities and user interfaces vary. This example uses a particular Cisco router.

Ideally the Gateway would be left in DHCP mode, and the router configured to keep assigning the same address. If this functionality is supported by the router it might look like Figure 29, here called ‘DHCP Reservation’.

**Figure 29: DHCP Reservation on our example Cisco router**

The screenshot shows the 'Network Setup' configuration page for a Cisco router. It is divided into two main sections: 'Router Address' and 'DHCP Server Setting'.  
 Under 'Router Address', the IP Address is 192.168.1.1, Subnet Mask is 255.255.255.0, and Device Name is empty.  
 Under 'DHCP Server Setting', the DHCP Server is 'Enabled'. A 'DHCP Reservation' button is highlighted with a black box. The Start IP Address is 192.168.1.100, Maximum Number of Users is 50, and the IP Address Range is 192.168.1.100 to 149. Client Lease Time is 0 minutes. Static DNS and WINS fields are all set to 0.

As can be seen in the above screenshot, the router has a defined range of 50 IP addresses it has reserved for DHCP allocation, between 100 to 149 for the last field in the address. The DHCP Reservation screen allows examination of the currently logged on devices, and the option of assigning an address in the allowed range to our Gateway. Alternatively, an address can be assigned outside the DHCP range but the Gateway must be configured also.

The screenshot of Figure 30 shows the DHCP reservation screen; here we are assigning an address outside the range (ending in '37').



Figure 30:  
Assigning an IP  
address outside  
the router's DHCP  
reservation range

**DHCP Reservation**

Select Clients from DHCP Tables

Client Name	Interface	IP Address	MAC Address	Select
	LAN	192.168.1.37	00:04:A3:11:CA:25	<input type="checkbox"/>
	LAN	192.168.1.100	00:1E:8F:37:41:9B	<input type="checkbox"/>
	Wireless-N	192.168.1.101	88:87:17:BA:D6:1B	<input type="checkbox"/>
	LAN	192.168.1.102	40:61:86:F7:CF:1E	<input type="checkbox"/>
	Wireless-G	192.168.1.103	00:14:A5:A3:80:CB	<input type="checkbox"/>
	Wireless-N	192.168.1.104	9C:B7:0D:7D:1C:AB	<input type="checkbox"/>
	LAN	192.168.1.105	00:24:8C:D6:B9:24	<input type="checkbox"/>
	LAN	192.168.1.107	8C:89:A5:90:A0:A7	<input type="checkbox"/>
	LAN	192.168.1.108	00:21:6B:68:70:98	<input type="checkbox"/>
	LAN	192.168.1.142	00:E0:81:4C:4B:AE	<input type="checkbox"/>
	LAN	192.168.1.109	60:EB:69:5E:9A:CD	<input type="checkbox"/>
	LAN	192.168.1.110	14:DA:E9:2A:34:38	<input type="checkbox"/>
	Wireless-N	192.168.1.111	74:2F:68:3D:04:EA	<input type="checkbox"/>
	Wireless-N	192.168.1.112	10:40:F3:C2:27:1F	<input type="checkbox"/>
	LAN	192.168.1.113	00:22:68:6D:37:F7	<input type="checkbox"/>
	Wireless-N	192.168.1.114	00:21:5C:30:3E:7D	<input type="checkbox"/>
	LAN	192.168.1.115	E8:9A:8F:A1:A7:6F	<input type="checkbox"/>
	Wireless-N	192.168.1.116	F0:CB:A1:51:16:89	<input type="checkbox"/>
	LAN	192.168.1.117	04:0C:CE:CF:0D:46	<input type="checkbox"/>
	LAN	192.168.1.118	D8:30:62:A6:19:4D	<input type="checkbox"/>
	LAN	192.168.1.119	4C:0F:6E:34:15:64	<input type="checkbox"/>

**1.**

Manually Add Client

Enter Client Name	Assign IP Address	To This MAC Address	
<input type="text"/>	192.168.1.0	00:00:00:00:00:00	<input type="button" value="Add"/>

Clients Already Reserved

Client Name	Assign IP Address	To This MAC Address	MAC Address
<input type="text"/>	192.168.1.37	00:04:A3:11:CA:25	<input type="button" value="Remove"/>

**2.**

Having decided upon an IP address, we now need to configure the Gateway.

On the touch screen of the Communication Gateway, press 'Gateway', then the 'Network' button. This will bring up the screen shown in Figure 31.

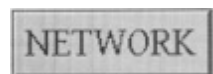
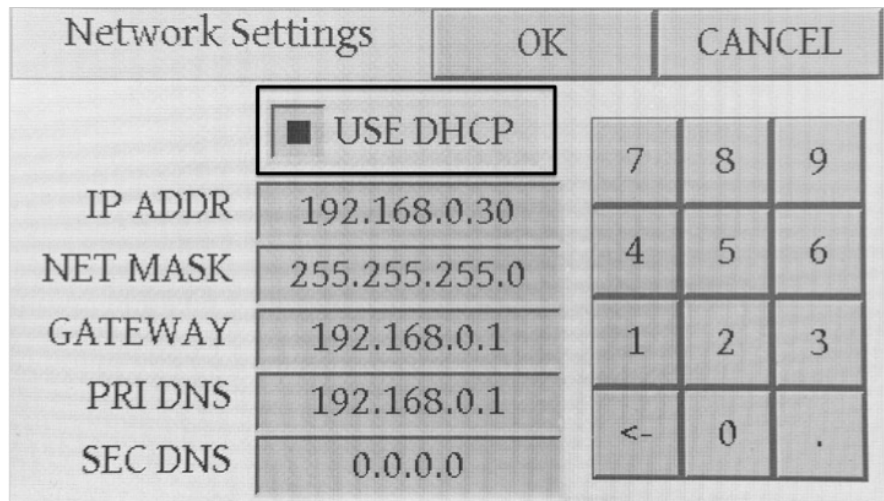

Figure 31: Network setting screen on the Gateway



The 'DHCP' check box indicates current status as well as allowing parameters to be changed if DHCP is unchecked. When unchecked it looks like this:



Touching on one of the fields below the check box will activate it and allow changes to be made using the on-screen keypad.

In general:

- Network sub mask will stay at 255.255.255.0 unless being used in certain big companies that might use something different.
- 'Gateway' and 'Pri DNS' (primary DNS) will be taken from the router screen.
- 'Sec DNS' (secondary DNS) will probably stay at 0.0.0.0.

### 6.5.11. Accessing the Gateway from Outside the Local Network – WAN-side configuration

For our example Cisco router, opening up a port for outside communication is achieved through the 'Application and Gaming' screen, see Figure 32. The aim is for communication to pass through the router, although there will usually be some translation of port labels between what the Gateway expects and what is presented to the outside world on the WAN side of the router.

There are 4 possible ports required to fully access the Gateway and inverters remotely. Access to the control web page alone requires only the first of those listed in Table 3 to be set up.

Label	Function	External (Customer-changeable as required)	Internal (what the Gateway expects to see)
HTTP	Allows access to the Gateway web page	8100	80
FTPC	FTP Control — allows access to the Gateway memory card and logs	2100	21
FTPD	FTP Data — the return port for files requested using FTPC to be transmitted through	8000 (Use this setting only)	8000
Diag	Diagnostic — Low level system access such as firmware updates for use by the manufacturer only	1000 (Use this setting only)	1000

Table 3: Port numbering assignments



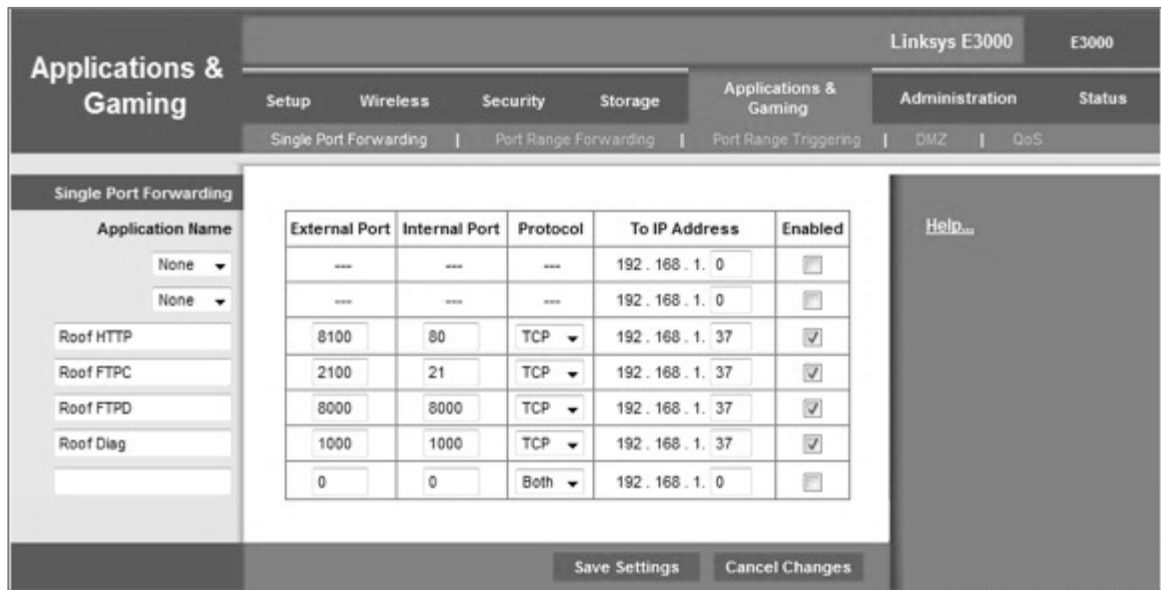

Figure 32: Port forwarding screen on our example router

Click on the 'Save Settings' button on the router page or else changes will be lost.

Note that not all routers offer port reassignment as described here. However, having different external port numbers is not strictly necessary; it is suggested as an extra security precaution to avoid using the well-known port assignments for web (80) and FTP (21) on the general Internet. The Gateway's web and FTP servers are both password protected, so the risks are low. In a case where no port forwarding is available, the Gateway direct port numbers (80, 21, 8000, 1000) would be used without specifying different external ports for 80 and 21.

## 7. Troubleshooting

The primary way of troubleshooting a system is to use the Communication Gateway (GW) to provide clues. The GW can be viewed using the touch screen interface on the device, or accessing it using a web browser. Assuming the issue is not with communications, browser access has the advantage that a mobile device such as a phone can be used while physically on the roof. As detailed later, the inverter has an indicator light that will also provide insight.



The troubleshooting section is divided up as follows:

- Overview of possible issues (picture).
- If I had this issue, it would look like these symptoms (table).
- If I had these symptoms it could be one of these causes (table).
- More details on selected issues.

### 7.1. Overview of Possible Issues

Letters on the right (e.g. **(A)**) refer to explanatory notes in Section 7.4.

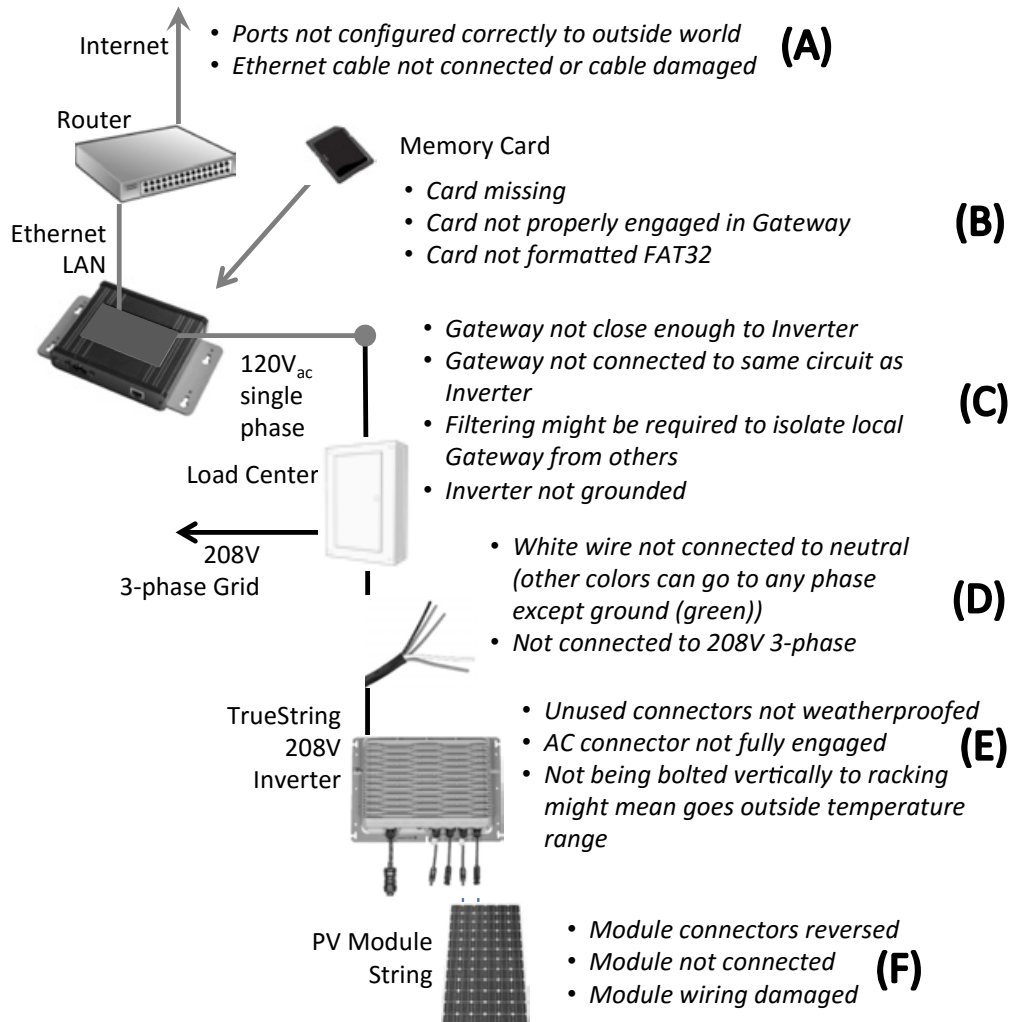

**Figure 33: Possible issues diagram**

## 7.2. If I had this issue, it would look like these symptoms

Letters next to individual faults (e.g. (D)) refer to explanatory notes in Section 7.4.

If this fault occurred I would see.....		Gateway Touch Screen	Web Interface	Inverter Button
AC Grid	<ul style="list-style-type: none"> <li>AC output of inverter not connected to grid <b>(D)</b></li> <li>AC connector not fully engaged <b>(D)</b></li> </ul>	Missing figures in AC part of display	As touch screen	Rapidly flashing red
	<ul style="list-style-type: none"> <li>One phase of AC Grid not connected <b>(D)</b></li> <li>Neutral (white or grey) wire connected to a phase instead of neutral <b>(D)</b></li> </ul>	One column of figures in AC part of display missing		
	<ul style="list-style-type: none"> <li>Connected to wrong voltage system (e.g. 480V 3-phase) <b>(D)</b></li> </ul>	Fault probably indicated		
Other	<ul style="list-style-type: none"> <li>Unterminated connectors allow moisture to ingress <b>(E), (F)</b></li> </ul>	Fault indicated		
PV Module	<ul style="list-style-type: none"> <li>PV module not connected <b>(F)</b></li> <li>PV module wiring fault <b>(F)</b></li> </ul>	Not treated as a fault – missing statistics in Panel figures		-
	<ul style="list-style-type: none"> <li>Number of modules not matching number set in the web interface <b>(F)</b></li> </ul>			
	<ul style="list-style-type: none"> <li>Arc fault detected and system shut down <b>(F)</b></li> </ul>	System not generating, fault indicated		Red lights rapidly flashing on inverter
Gateway	<ul style="list-style-type: none"> <li>The Gateway is wired into an unrelated AC circuit <b>(C)</b></li> <li>The Gateway is too far away from an inverter <b>(C)</b></li> <li>The Gateway is the wrong side of filtering on the AC circuit <b>(C)</b></li> <li>Neutral (white or grey) wire connected to a phase <b>(D)</b></li> <li>Inverter not grounded <b>(C)</b></li> </ul>	No signal or information	No information, status 'Unknown'	-
	<ul style="list-style-type: none"> <li>No Ethernet connection <b>(A)</b></li> </ul>	Healthy statistics on the touch screen, [Gateway] tab shows Ethernet greyed out	Unable to connect from the web interface	
	<ul style="list-style-type: none"> <li>Network router not configured correctly <b>(A)</b></li> </ul>	Healthy statistics on the touch screen		
	<ul style="list-style-type: none"> <li>No memory card <b>(B)</b></li> <li>Memory card not fully engaged <b>(B)</b></li> <li>Memory card not formatted as FAT32 <b>(B)</b></li> </ul>	Healthy statistics on the touch screen, [Gateway] tab shows greyed out card characteristics	Retrieving long term history not possible	

**Table 4: Faults and consequent symptoms**

### 7.3. If I had these symptoms, it could be one of these causes

Letters on the right next to individual faults (e.g. **(D)**) refer to explanatory notes in Section 7.4.

Symptoms			Possible Causes
Inverter Button Indicator	Gateway Touch Screen	Web Interface	
Button flashing red quickly	Missing information in AC display	As touch screen	<ul style="list-style-type: none"> <li>AC output of inverter not connected to Grid <b>(D)</b></li> <li>AC connector not fully engaged <b>(D)</b></li> </ul>
	Missing information in AC display		<ul style="list-style-type: none"> <li>One phase of AC Grid not connected <b>(D)</b></li> <li>Connected to wrong voltage system (e.g. 480V 3-phase) <b>(D)</b></li> </ul>
	Fault condition displayed		<ul style="list-style-type: none"> <li>Moisture has been allowed into the system, perhaps because unused connectors have been left un-terminated <b>(E) (F)</b></li> </ul>
-	Missing PV Module information		<ul style="list-style-type: none"> <li>Missing PV module <b>(F)</b></li> <li>Faulty wiring or connectors not fully engaged <b>(F)</b></li> </ul>
	Less power output than expected		<ul style="list-style-type: none"> <li>Inverter in direct sun and temperature range exceeded, causing output to be reduced to maximize lifetime <b>(E)</b></li> </ul>
	Memory card characteristics greyed out		<ul style="list-style-type: none"> <li>Memory card not fully engaged <b>(B)</b></li> <li>Memory card not formatted as FAT32 <b>(B)</b></li> <li>Memory card missing <b>(B)</b></li> </ul>
	No information on the Gateway touch screen	No information on the web interface	<ul style="list-style-type: none"> <li>Gateway not connected to the same AC circuit as the inverter(s) <b>(C)</b></li> <li>Gateway placed too far from the inverter(s) <b>(C)</b></li> <li>Filtering present on the Grid interfering with communication <b>(C)</b></li> <li>Neutral (white or grey) wire connected to a phase <b>(D)</b></li> <li>Inverter not grounded <b>(C)</b></li> </ul>
	Normal information on the Gateway touch screen		<ul style="list-style-type: none"> <li>Ethernet cable not connected <b>(A)</b></li> <li>Router external ports/ firewall not set up correctly <b>(A)</b></li> </ul>













**Table 5: Symptoms and possible causes**

## 7.4. Notes on Selected Issues.

### 7.4.1. Inverter Button Indicator States







If there is power to the inverter, the indicator on the inverter button will be indicating something. As described earlier, these have the following meanings and operations:



Inverter Button Push	Button Indication <sup>3</sup>	Result
1 press 		<ul style="list-style-type: none"> <li>Make inverter beep (“are you alive?”)</li> </ul>
2 presses 		<ul style="list-style-type: none"> <li>‘Off &amp; Locked’ - disabled</li> <li>Do not 5-minute self-start</li> </ul>
3 presses 		<ul style="list-style-type: none"> <li>Start generating immediately</li> <li>If locked, unlock &amp; generate immediately</li> <li>(If system is faulted, will unlock but won’t generate)</li> </ul>
Long press (>2 seconds) 	 (Brief flash)	<ul style="list-style-type: none"> <li>Alternate functions mode, ready to accept further button pushes. Times out after 10 seconds</li> </ul>
1 press (after long press) 		<ul style="list-style-type: none"> <li>Clear latched faults, for example after arc-fault test has initiated a fault condition</li> </ul>
4 presses (after long press) 		<ul style="list-style-type: none"> <li>Arc-fault test activation. Successful operation of arc-fault detection should cause a fault condition (rapid red flashing) until cleared</li> </ul>

**Table 6: Inverter button functions and indicator meanings (repeat of Table 1)**

<sup>3</sup> Orientation may vary

Inverter Indicator State	Meaning
 Solid	<ul style="list-style-type: none"> <li>Powered up</li> <li>Not generating</li> <li>No faults</li> </ul>
 Left-right flash	<ul style="list-style-type: none"> <li>Power-on self-test (will take &lt;1 minute)</li> </ul>
 Green Chaser	<ul style="list-style-type: none"> <li>Powered up</li> <li>Generating, no faults</li> </ul>
 Rapid Flash	<ul style="list-style-type: none"> <li>Faulted, e.g. arc detected</li> </ul>
 Mostly On	<ul style="list-style-type: none"> <li>'Off &amp; Locked' - disabled</li> </ul>
 Mostly Off	<ul style="list-style-type: none"> <li>Sleeping – not generating</li> </ul>

**Table 7: Inverter button functions and indicator meanings (repeat of Table 2)**

**(A) Internet Connectivity Issues**

- i) No Ethernet connection
- ii) Network router not configured correctly
- iii) Router external ports/ firewall not set up correctly

Other than a faulty or damaged cable (RJ45 Ethernet cables are a common culprit), the majority of issues relate to the configuration of the local router. This topic is covered in Section 6.5.9 onwards. If the local Ethernet cable is faulty, you will see the following on the Gateway (Figure 34).

**Figure 34: Gateway indication of missing local Ethernet connection**

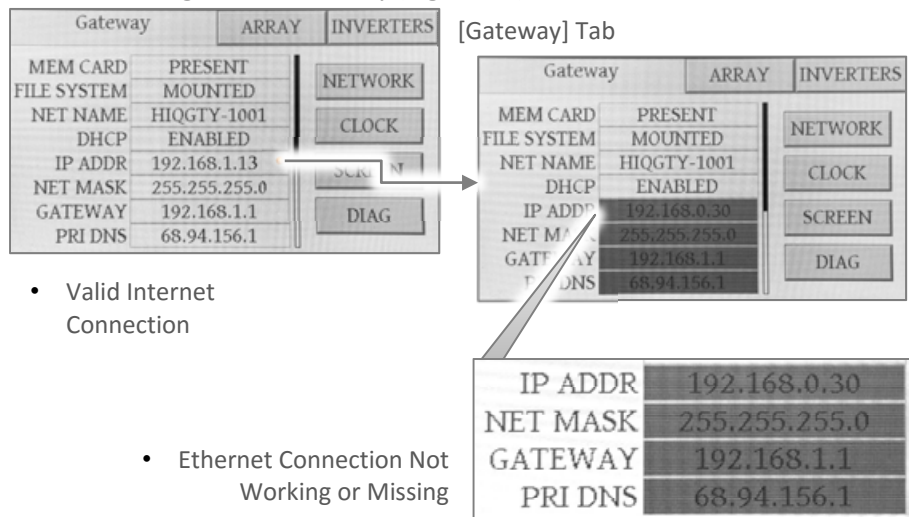

The screenshot shows the 'Gateway' configuration screen with tabs for 'Gateway', 'ARRAY', and 'INVERTERS'. The 'Gateway' tab is active, displaying a table of network settings and several control buttons. A callout box labeled '[Gateway] Tab' provides a detailed view of the network configuration.

Gateway	ARRAY	INVERTERS
MEM CARD	PRESENT	
FILE SYSTEM	MOUNTED	
NET NAME	HIQGTY-1001	
DHCP	ENABLED	
IP ADDR	192.168.1.13	
NET MASK	255.255.255.0	
GATEWAY	192.168.1.1	
PRI DNS	68.94.156.1	

Buttons: NETWORK, CLOCK, SCREEN, DIAG

[Gateway] Tab

MEM CARD	PRESENT
FILE SYSTEM	MOUNTED
NET NAME	HIQGTY-1001
DHCP	ENABLED
IP ADDR	192.168.0.30
NET MASK	255.255.255.0
GATEWAY	192.168.1.1
PRI DNS	68.94.156.1

Buttons: NETWORK, CLOCK, SCREEN, DIAG

- Valid Internet Connection
- Ethernet Connection Not Working or Missing

### (B) Gateway Memory Card Issues

- i) No memory card
- ii) Memory card not fully engaged
- iii) Memory card not formatted as FAT32

Logging of long-term performance data is saved to the memory card that was supplied with the Gateway. Note that the card is not required for the system to operate, only to retain history information. If the card is in place but not fully engaged, you will see the symptoms shown in Figure 35.

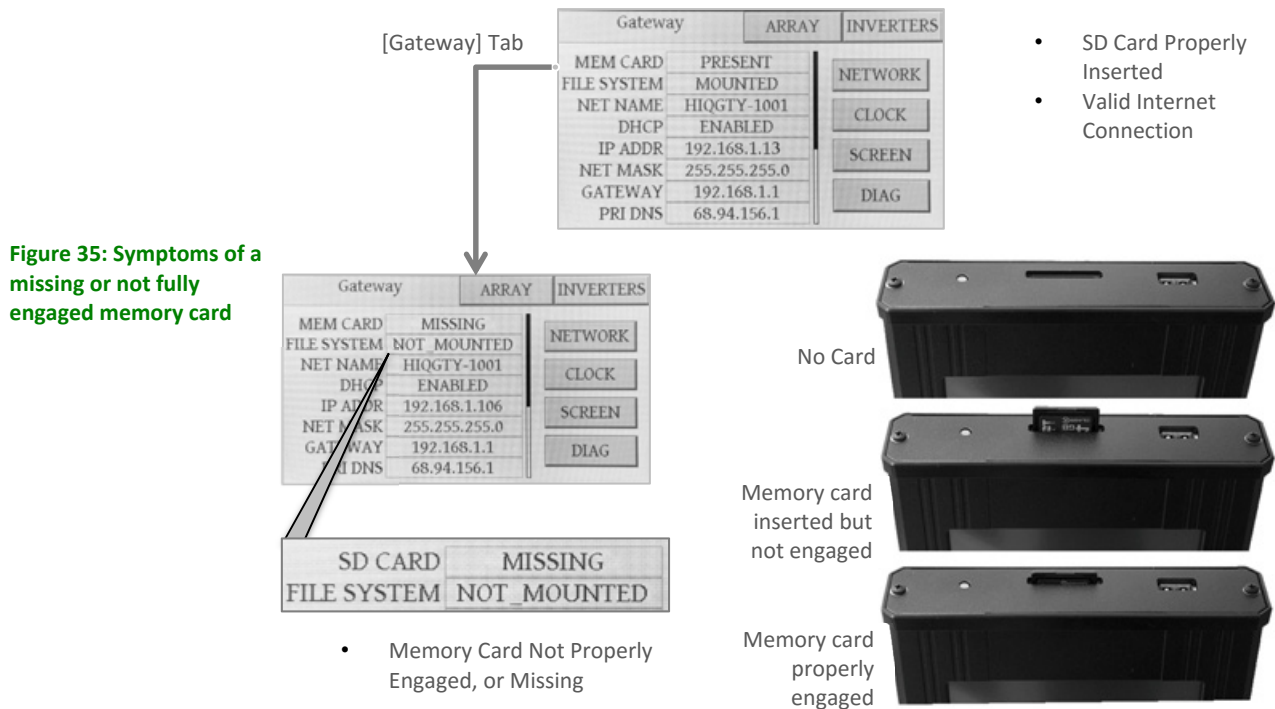

The card is formatted with the FAT32 file system. If you wish to use a different memory card than the one supplied, it will need to be formatted similarly. This can usually be achieved on a personal computer. Consult your computer manual for details.

### (C) Gateway to Inverter Connectivity Issues

- i) The Gateway is wired into an unrelated AC circuit
- ii) The Gateway is too far away from inverter(s)
- iii) The Gateway is the wrong side of filtering on the AC circuit
- iv) Filtering present on the Grid interfering with communication

The Communication Gateway connects to local inverters using Power Line Communications (PLC). For communication to work the Gateway must receive a strong enough signal above the noise. It obviously must be on the same electrical circuit as the PV system, which isn't always easy to establish in a typical company electrical closet with many different circuits present.

Assuming the Gateway is on one phase of the correct PV system circuit, then issues are likely to arise if the signal strength is low, or equipment between the Gateway and PV system is interfering with or filtering the signal. In either case moving the Gateway closer to the PV system is likely to be the best answer.

It is also possible that two Gateways (or other inverter control devices from other manufacturers nearby) are interfering with each other. In this case an isolating filter to separate the inverter communications from the outside world might be required.

Note that a failure to establish communications can also occur if the neutral (white or grey) wire is connected incorrectly to one of the phases as discussed in the next section.

### (D) AC Wiring Issues

- i) AC output of inverter not connected to grid
- ii) AC connector not fully engaged
- iii) One phase of AC grid not connected
- iv) Neutral (white or grey) wire connected to a phase instead of neutral
- v) Connected to wrong voltage system (e.g. 208V 3-phase)

The inverter auto-senses the phases connected to it, so when wiring the system to the grid it does not matter which of the red, blue or orange wires are connected to which phase. However, connecting the neutral (white or grey) wire to one of the phases will show up as a fault, the same fault if one of the 3 phases is disconnected. These conditions will not damage the inverter but should be corrected.

If one of the phases is not connected, the web and touch screen views will have one of the AC phases faulted rather than all three.

If the neutral is connected to one phase the power line communications to the Gateway may not work.

Figure 36: AC wiring scheme used for the ProHarvest 208V Inverter

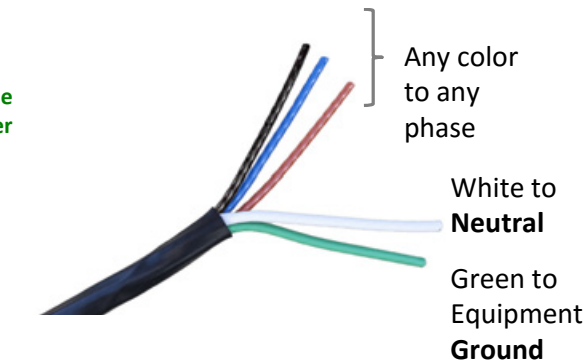

	<p><b>CAUTION: Hazard to Equipment</b></p> <p>If the inverter is connected to the wrong voltage system, such as 480V 3-phase, damage is likely to result. The system will need to be returned to the factory.</p>
--	---



### (E) Inverter Installation Issues

- i) Unterminated connectors allow moisture to ingress
- ii) Inverter in direct sun and temperature range exceeded, causing output to be reduced due to high internal temperatures. This protective feature helps to extend the lifetime of the inverter.

The inverter is NEMA6 rated and very robust. To maximize reliability and performance for the longest lifetime it should be mounted vertically in the shade and bolted to metal racking if available. However, it can be ballast-mounted in the shade. If the device is placed in a situation where it exceeds its rated temperature range it will reduce output power slightly until it is safely back within the operating temperature range.

As with all such devices, NEMA6 waterproof operation requires that all connectors, whether used or unused, be properly terminated. If this is not the case, moisture may ingress, causing the unit to eventually fail.

### (F) PV Module Wiring Issues

- i) PV module not connected
- ii) PV module wiring fault
- iii) Faulty wiring or connectors not fully engaged
- iv) Missing PV module

These are generally self-explanatory issues of connectors not engaged or damaged wiring.

## 8. Specifications

### 8.1. Power System Specifications

<b>Inverter Specifications</b>	
DC Input (2 identical inputs)	
Maximum open circuit voltage per String, $V_{oc}$	1,000 $V_{dc}$
Full power MPPT range, per string	325-525 $V_{dc}$
PV start voltage	200 $V_{dc}$
DC allowable stacking ratio (total, 2 inputs combined)	Must not exceed 8.9 under any circumstances <sup>4</sup>
DC maximum input current, per DC input	10 A
DC maximum source short circuit current	30 A
DC maximum input source back feed current to input source	0 A
DC disconnect means	The DC connector has been evaluated and approved for use as the load-break disconnect required by the NEC <sup>5</sup>
AC Output	
AC maximum continuous output power to 45°C	5.75 $kW_{ac}$ max
AC de-rate with temperature, 45 to +65°C	-102 $W/°C$

<sup>4</sup> Stacking: On the DC side of the inverter, each input limits at 3 kW and/or 10A, and the combined total AC output is limited to 5.75 kW. Higher DC STC string powers may be applied. The inverter will limit as described above. Total stacking for inverter must not exceed 8.9 under any circumstances

<sup>5</sup> NEC section 690.17, allowed by the exception of meeting requirements specified in 690.33

AC nominal output current, per phase		16.0 A	
AC maximum continuous output current, per phase		16.0 A	
AC maximum output overcurrent protection		60 A	
AC 3-phase system compatibility		208V Wye, 3 phases, neutral and ground	
AC voltage range, phase to phase (min / nominal / max)		183 / 208 / 229 V (Limits adjustable, see below)	
AC voltage range, phase to neutral (min / nominal / max)		106 / 120 / 132 V (Limits adjustable, see below)	
AC operating frequency range (min / nominal / max)		59.3 / 60 / 60.5 Hz (Limits adjustable, see below)	
Power Factor		>0.98	
AC output waveform		True sine wave	
AC lower frequency trip limit	Default	59.3 Hz	+/- 0.1 Hz
	Adjustment	57-59.8 Hz in 0.1 Hz increments	
	Clearing time default	0.16 s	+/- 2 cycles
	Clearing time adjustment	0.16-300 s	
AC upper frequency trip limit	Default	60.5 Hz	+/- 0.1 Hz
	Adjustment	60.5-62.0 Hz in 0.1 Hz increments	
	Clearing time default	0.16 s	+/- 2 cycles
	Clearing time adjustment	0.16-300 s	
AC lower voltage trip limit	Default	106 V	+/- 2 %
	Adjustment	85-106 V	
	Clearing time default	2 s	+/- 2 cycles
	Clearing time adjustment	1-20 s	
AC upper voltage trip limit	Default	132 V	+/- 2 %
	Adjustment	132-144 V	
	Clearing time default	1 s	+/- 2 cycles
	Clearing time adjustment	1-20 s	
AC reconnect delay	Default	5 minutes	+/- 1 s
	Adjustment	1 s -10 mins	
AC synchronization in-rush current	0A		
Maximum output Fault current and duration	16A, 0.5 ms		
AC minimum wire gauge for the grid connection	12 AWG		
AC disconnect means	The AC connector has been evaluated and approved for use as the load-break disconnect required by the NEC <sup>6</sup> .		

<sup>6</sup> NEC section 690.17, allowed by the exception of meeting requirements specified in 690.33

<b>Other Specifications</b>	
Peak efficiency	98 %
CEC efficiency	97%
Weight	11 kg (24 lb.)
Operating temperature range	-40 to +65 °C (-40 to +150 °F)
Power consumption standby/ night	<4.5 W / <4.5 W
Cooling	Natural convection, no cooling fan
Communication	Power Line Communication
Environmental rating	Outdoor / rooftop, NEMA6, IP67
Certification, inverter	UL 1741 / IEEE 1547 (Utility Interactive), CSA C22.2 NO. 107.1, FCC Part 15 <sup>7</sup> . Meets the requirements of NEC 690.11
Included warranty	10 Years, optionally extendable

## 8.2. Communications Gateway Specifications

<b>Gateway Specifications</b>	
AC input voltage, min/nom/max	106 / 120 / 132 V
AC frequency, min/nom/max	59.3/60.0/60.5 Hz
Operating ambient temp range	-20 to +50 °C
Power consumption	1.5W typical (4W max)
Mounting, environmental rating	Indoor — NEMA 1
Memory card	SD compatible, 4-32GB tested, FAT32 formatted
Communication with inverter	Proprietary Power Line Communication
LAN connection, Ethernet	10/100BASE, RJ45 8P8C modular plug
Limited warranty	15 years, optionally extendable
Compliance, certifications	UL 60950-1, CSA C22.2 No. 60950-1, FCC Part 15 <sup>7</sup>
Weight	1.3lbs

<sup>7</sup> Note: This equipment has been tested and found to comply with the limits for a Class B digital device, pursuant to part 15 of the FCC Rules. These limits are designed to provide reasonable protection against harmful interference in a residential installation. This equipment generates, uses and can radiate radio frequency energy and, if not installed and used in accordance with the instructions, may cause harmful interference to radio communications. However, there is no guarantee that interference will not occur in a particular installation. If this equipment does cause harmful interference to radio or television reception, which can be determined by turning the equipment off and on, the user is encouraged to try to correct the interference by one or more of the following measures:

- Reorient or relocate the receiving antenna.
- Increase the separation between the equipment and receiver.
- Connect the equipment into an outlet on a circuit different from that to which the receiver is connected.
- Consult the dealer or an experienced radio/TV technician for help.

### 8.3. Unit Rating Label

One of the following labels appear on the back of the unit baseplate.





**proharvest™**  
by OutBack Power

Utility-Interactive 3 Phase Inverter  
Model: TS208-5k75  
Part No: PRO208-5k75 Powered by  
HiQ Solar

S/N:

AC Maximum Continuous Output Power: 5.75 kW  
AC Maximum Continuous Output Current: 16.0 A  
3-Phase AC Output (min/nom/max): 183/208/229 V  
Full Power MPPT Range, Per String: 325 to 525 VDC  
DC Maximum Input Current: 10 A per input  
Operating Frequency (min/nom/max): 59.3/60/60.5 Hz  
Maximum Branch Circuit Overcurrent Protection: 60 A  
Power Factor: >0.98  
Operating Temperature Range: -40°C to +65°C  
This Unit Incorporates AFCI Per NEC 690.11  
This Unit Complies With NEC 690.35  
This Unit Complies With FCC Part 15  
Raintight Enclosure NEMA 6  
Patents Pending

  Complies with  
UL 1741  
E113207 CSA C22.2 NO 107.1





**HiQ  
Solar**

Utility-Interactive 3 Phase Inverter  
Model: TS208-5k75

S/N:

AC Maximum Continuous Output Power: 5.75 kW  
AC Maximum Continuous Output Current: 16.0 A  
3-Phase AC Output (min/nom/max): 183/208/229 V  
Full Power MPPT Range, Per String: 325 to 525 VDC  
DC Maximum Input Current: 10 A per input  
Operating Frequency (min/nom/max): 59.3/60/60.5 Hz  
Maximum Branch Circuit Overcurrent Protection: 40 A  
Power Factor: >0.98  
Operating Temperature Range: -40°C to +65°C  
This Unit Incorporates AFCI Per NEC 690.11  
This Unit Complies With NEC 690.35  
This Unit Complies With FCC Part 15  
Raintight Enclosure NEMA 6  
Patents Pending

  Complies with  
UL 1741  
E113207 CSA C22.2 NO 107.1

## 8.4. System UL 1741 Certificate



**MET Laboratories, Inc.** *Safety Certification - EMI - Telecom - Environmental Simulation - NEBS*  
914 WEST PATAPSCO AVENUE • BALTIMORE, MARYLAND 21230-3432 • PHONE (410) 949-1802 • FAX (410) 354-3313

October 15, 2015

Mr. Marv Dargatz  
HiQ Solar  
Suite 101  
2030 Duane Avenue  
Santa Clara, CA. 95054  
U.S.A

Subject: Amendment to HiQ Solar Inverter model TS480-8k  
-Addition of Alternate HiQ Solar Inverter model TS208-5k75  
Listing Number E113207; MET Project Number 86966  
Safety Standards: • UL 1741: Standard for Safety for Inverters, Converters, and  
Controllers for Use in Independent Power Systems, Second Edition  
• CSA C22.2 NO. 107.1-01 (R2011) Third Edition General Use Power  
Supplies

Dear Mr. Dargatz:

Congratulations on successfully completing the MET Certification process for the alternate HiQ Solar Inverter model TS208-5k75. HiQ Solar may begin to apply the MET Mark on the above stated product at this time in accordance with the MET Mark Utilization Agreement or the MET Applicant Contract. The reports covering the above stated product will be forthcoming.

Thank you for the opportunity to perform this service for HiQ Solar. We look forward to future opportunities with your company.

*Sincerely,*  
MET LABORATORIES, INC.

Rick Cooper  
Director of Safety Business Line,  
Safety Laboratory



*The Nation's First Nationally Recognized Testing Laboratory*  
*MET Laboratories, Inc. is accredited by OSHA and the Standards Council of Canada.*

**NRTL**

Canadian Certification has been granted under a System 3 program as defined in ISO Guide 67.

## 8.5. Physical Dimensions & Drilling Guides

### 8.5.1. ProHarvest 208V Inverter

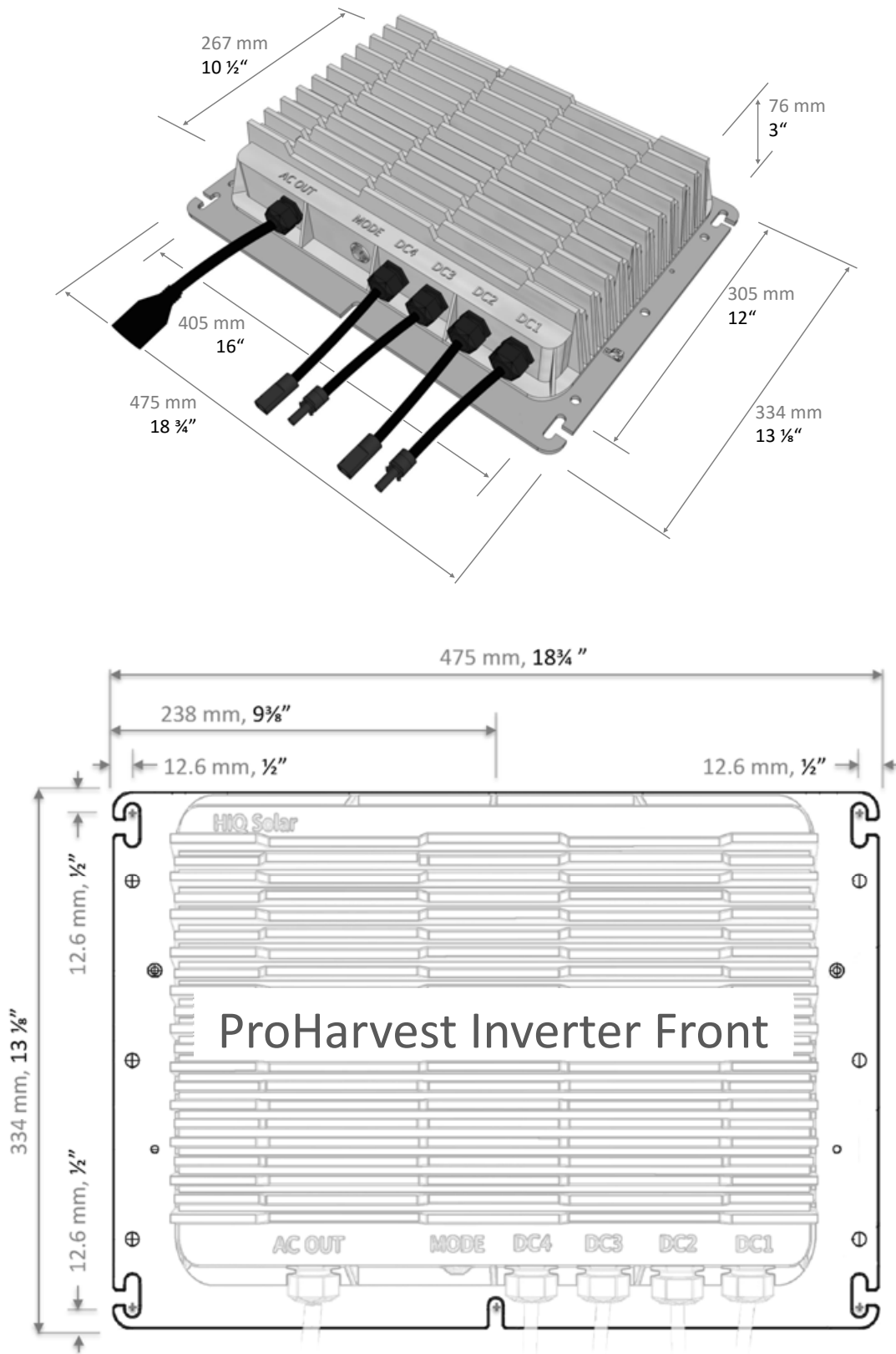

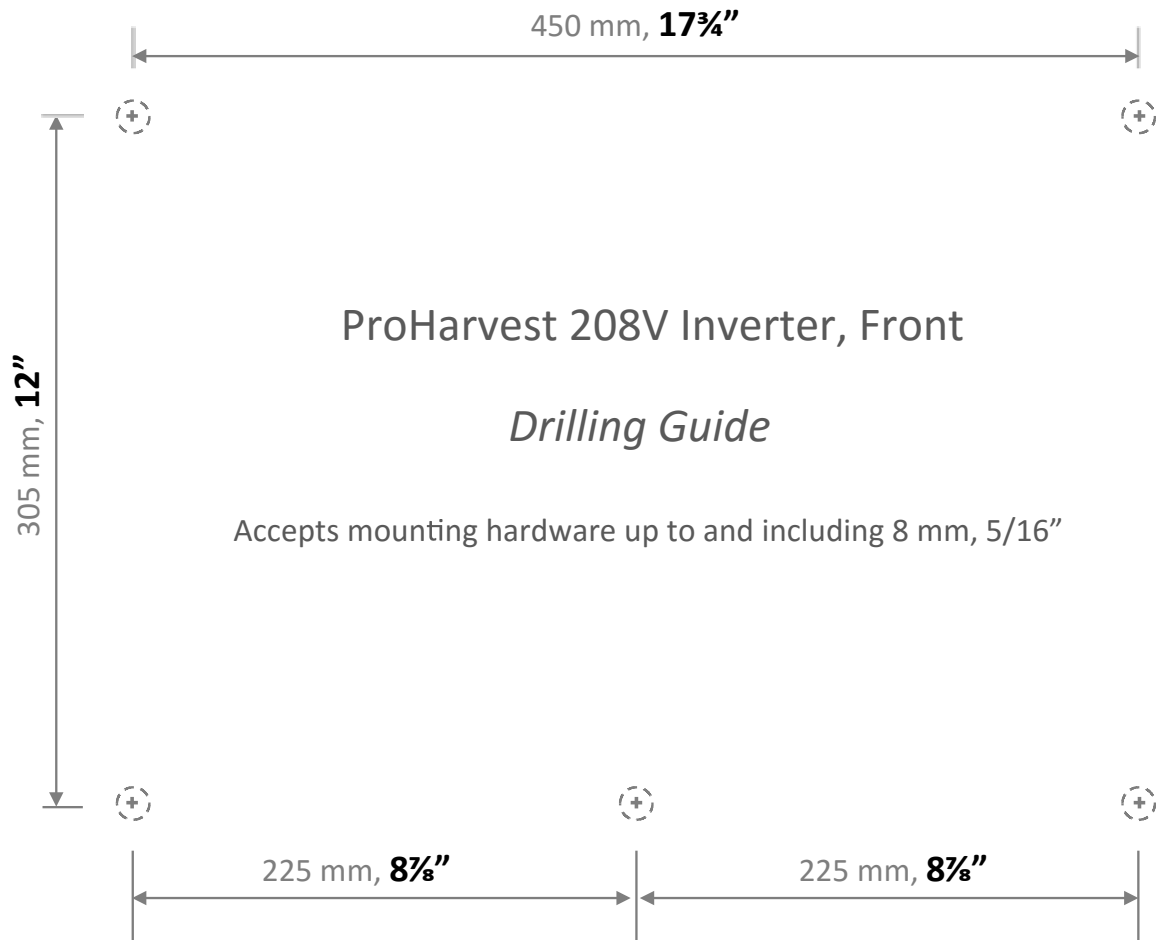

### 8.5.2. Gateway



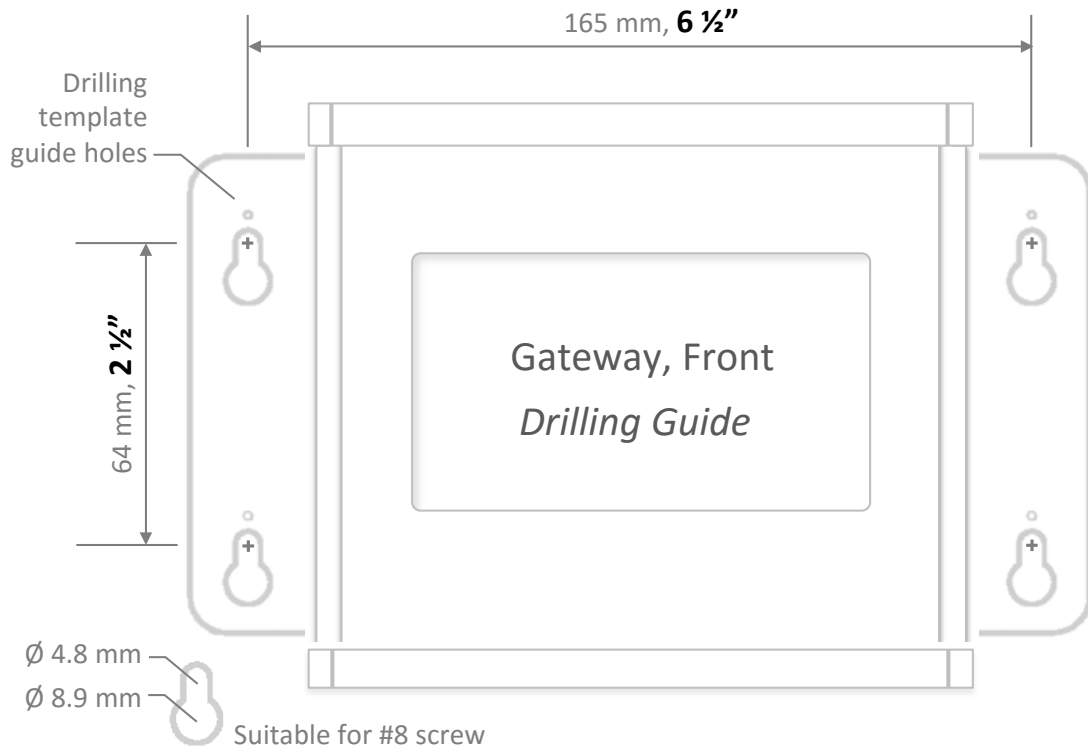

Corporate Headquarters  
17825 – 59<sup>th</sup> Avenue N.E.  
Suite B  
Arlington, WA 98223 USA

+1.360.435.6030  
+1.360.618.4363 (Technical Support)  
+1.360.435.6019 (Fax)

Support@outbackpower.com  
<http://www.outbackpower.com>