

M215 Safety (M215-60-2LL-S22-IG / S23-IG / S24-IG)

Important Safety Information

This document contains important instructions to use during installation of the Enphase M215 Microinverter™. To reduce the risk of electrical shock, and to ensure the safe installation and operation of the Enphase Microinverter, follow these instructions. The following safety symbols and information indicate dangerous conditions and important safety instructions.

Product Labels

	WARNING: Hot surface.
	DANGER: Risk of electrical shock.
	Refer to product instructions.















Safety and Advisory Symbols









	DANGER! This indicates a hazardous situation, which if not avoided, will result in death or serious injury.
	WARNING! This indicates a situation where failure to follow instructions may be a safety hazard or cause equipment malfunction. Use extreme caution and follow instructions carefully.
	WARNING! This indicates a situation where failure to follow instructions may result in burn injury.
	NOTE: This indicates information particularly important for optimal system operation. Follow instructions closely.

Safety Instructions

	DANGER: Before installing or using the Enphase Microinverter, read all instructions and cautionary markings in the technical description, on the Enphase Microinverter System, and on the photovoltaic (PV) equipment.
	DANGER: Do not use Enphase equipment in a manner not specified by the manufacturer. Doing so may cause death or injury to persons, or damage to equipment.
	DANGER: Risk of Electrical Shock. Be aware that installation of this equipment includes risk of electric shock. Do not install the AC junction box without first removing AC power from the Enphase System.
	DANGER: Risk of Electrical Shock. Do not install the Engage Cable terminator cap while power is connected.
	DANGER: Electric shock hazard. The DC conductors of this photovoltaic system are ungrounded and may be energized.
	WARNING: Always de-energize the AC branch circuit before servicing. Never disconnect the DC connectors under load. Disconnect DC connections first, then disconnect AC connections.
	WARNING: The body of the Enphase Microinverter is the heat sink. Under normal operating conditions, the temperature is 15°C above ambient, but under extreme conditions the microinverter can reach a temperature of 80°C. To reduce risk of burns, use caution when working with microinverters.
	WARNING: When pairing with an M215 (M215-60-2LL-S22-IG / S23-IG / S24-IG), the PV module DC conductors must be labeled “PV Wire” or “PV Cable”.

	WARNING: If the AC cable on the microinverter is damaged, do not install the unit.
	WARNING: You must match the DC operating voltage range of the PV module with the allowable input voltage range of the Enphase Microinverter: 16-48 VDC.
	WARNING: The maximum open circuit voltage of the PV module must not exceed the specified maximum input DC voltage of the Enphase Microinverter: 48 VDC.
	WARNING: The M215 has field-adjustable voltage and frequency trip points that may need to be set, depending upon local requirements. Only an authorized installer with the permission and following requirements of the local electrical authorities should make adjustments.
	WARNING: Only use electrical system components approved for wet locations.
	WARNING: Only qualified personnel should troubleshoot, install, or replace Enphase Microinverters or the Engage Cable and Accessories.
	WARNING: Make sure protective sealing caps have been installed on all unused AC connectors. Unused AC connectors are live when the system is energized by the grid. Sealing caps may not be reused.

	WARNING: Ensure that all AC and DC wiring is correct and that none of the AC or DC wires are pinched or damaged. Ensure that all AC junction boxes are properly closed.
	WARNING: The microinverter must be installed under the module, out of rain and sun. Do not mount the microinverter in a position that allows long-term exposure to direct sunlight or in a vertical orientation that allows water to collect in the DC connector recess. Do not install the microinverter black side up or vertically, with the DC connectors facing up.
	WARNING: When installing the Engage Cable, secure any loose cable to minimize tripping hazard.
	WARNING: Do not leave AC connectors on the Engage Cable uncovered for an extended period. If you do not plan to replace the microinverter immediately, you must cover any unused connector with a sealing cap. Sealing caps may not be reused.
	WARNING: Do not exceed the maximum number of microinverters in an AC branch circuit as listed in this guide. You must protect each microinverter AC branch circuit with a 20A maximum breaker.
	WARNING: Do not connect Enphase Microinverters to the grid or energize the AC circuit(s) until you have completed all of the installation procedures and have received prior approval from the electrical utility company.
	WARNING: Do not attempt to repair the Enphase Microinverter; it contains no user-serviceable parts. If it fails, contact Enphase customer service to obtain an RMA (return merchandise authorization) number and start the replacement process. Tampering with or opening the Enphase Microinverter will void the warranty.
	WARNING: Be aware that only qualified personnel may connect the Enphase Microinverter to the utility grid.
	WARNING: Use the terminator only once. If you open the terminator following installation, the latching mechanism is destroyed. Do not reuse the terminator. If the latching mechanism is defective, do not use the terminator. Do not circumvent or manipulate the latching mechanism.
	WARNING: When stripping the sheath from the Engage Cable, make sure that the conductors are not damaged. If the exposed wires are damaged, the system may not function properly.
	WARNING: Perform all electrical installations in accordance with all applicable local electrical codes and the National Electrical Code (NEC), ANSI/NFPA 70.
	NOTE: To ensure optimal reliability and to meet warranty requirements, the Enphase Microinverter must be installed according to the instructions in this guide.
	NOTE: The AC and DC connectors on the cabling are rated as a disconnect only when used with an Enphase Microinverter.
	NOTE: Check the labeling on the Engage Cable drop connectors to be sure that the cable matches the electrical utility service at the site. Use 208 VAC (208 VAC three-phase) Engage Cable at sites with three-phase 208 VAC service, or use 240 VAC Engage Cable at sites with 240 VAC single-phase service.
	NOTE: There are two release-holes in the drop connector on the cable. These are not for mounting but are used to disconnect the connector. Keep these release holes clear and accessible.

	NOTE: When looping the Engage Cable, do not form loops smaller than 4.75 inches (12 cm) in diameter.
	NOTE: Protection against lightning and resulting voltage surge must be in accordance with local standards.
	NOTE: Many PV modules have a central stiffening brace. In these cases, do not position the connector and microinverter at the exact center of the PV module. Instead, position the drop connectors so that the connectors do not conflict with the braces.
	NOTE: If you need to remove a sealing cap, you must use the Enphase disconnect tool or a #3 Phillips screwdriver. Sealing caps may not be reused.
	NOTE: The M215 works with 240 VAC single-phase utility service or with 208 VAC three-phase utility service
	NOTE: When installing the Engage Cable and accessories, adhere to the following: <ul style="list-style-type: none"> • Do not expose the terminator cap or cable connections to directed, pressurized liquid (water jets, etc.). • Do not expose the terminator cap or cable connections to continuous immersion. • Do not expose the terminator cap or cable connections to continuous tension (e.g., tension due to pulling or bending the cable near the connection). • Use only the connectors and cables provided. • Do not allow contamination or debris in the connectors. • Use the terminator cap and cable connections only when all parts are present and intact. • Do not install or use in potentially explosive environments. • Do not allow the terminator to come into contact with open flame. • Make sure that all terminator cap seals are seated correctly in the wire organizer. • Fit the terminator cap using only the prescribed tools and in the prescribed manner. • Use the terminator to seal the conductor end of the Engage Cable; no other method is allowed.
	NOTE: Do not use the shipping cap to cover unused connectors. The shipping cap does not provide an adequate environmental seal. Enphase sealing caps are required to protect against moisture ingress.
	NOTE: Completely install all microinverters and all system AC connections prior to installing the PV modules.

Installing the M215 Microinverter

(M215-60-2LL-S22-IG / S23-IG / S24-IG)

The M215 meets the requirements of NEC 690.35. Because the DC circuit is isolated and insulated from ground, the M215 does not require that you install a GEC between microinverters. Ground fault protection (GFP) is integrated into the microinverter. To support this feature, the PV module must be equipped with DC cables labeled “PV Wire” or “PV Cable.”

1

Register the System

Register the System at the Enlighten website:
<https://enlighten.enphaseenergy.com>.

a. Log in to Enlighten

- At the installer dashboard, click **Add a New System**.

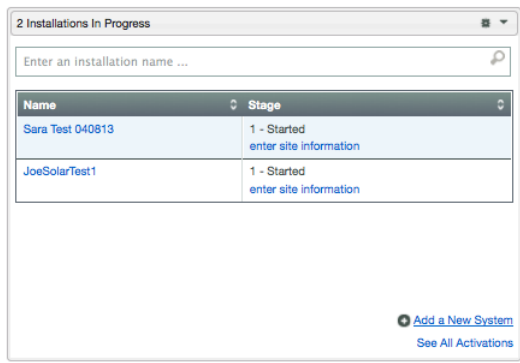

b. Enter System Activation Information

- Enter the System, Installer, Owner, and Location information.
- Enter the Envoy serial number. The serial number label is on the back of the Envoy, near the left mounting bracket.

c. Select the Grid Profile (if required)

In the continental US, you can skip this step because the factory settings meet requirements. If you have selected a country other than the US, or if you select Hawaii as the state under **Location**, the Grid Profile menu appears.

- Select the appropriate profile from the Grid Profile menu.
- Click **Save** to submit the form.

For more information on Grid Profiles, refer to the *Envoy Communications Gateway Installation and Operation Manual* at:
<http://www.enphase.com/support>.

System Activation form

System

*Name

Installer Reference

*Type

Third Party Owned (ex: PPA or Leased)

Installer

Enphase Energy

Owner

First Name

Last Name

Email

Phone

Owner will receive MyEnlighten for system performance monitoring.

Change Enlighten Version

Location

Country

Street Address

Street Address 2

City

State/Province

Zip/Postal Code

Envoy

*Internet Connection

Envoy Serial Number

[Add Another Envoy](#)

Grid Profile

Select one

IEEE1547

IEEE 1547 default

IEEE 1547 Mainland alternate

IEEE 1547 Hawaii HECO Utility

IEEE 1547 Hawaii MECO Utility

Hawaii KILUC 20121201

Modules

*Total Number of PV Modules (Panels)

PV Module

Select a Manufacturer

Don't see your manufacturer/model? [Let us know](#)

Installation

Microinverter Attachment Type

Array Type

Enter array-level details on the system settings page.

Installation Map

Scan or photograph the system's installation map and upload the file(s) here.

Upload A File:

No file selected

2

Connect the Envoy® Communications Gateway™

- Connect the Envoy to power and Internet according to the *Envoy Quick Install Guide*.
- Look for the + Web indication on the LCD screen.
- Leave the Envoy running while you install the microinverters so that any required Envoy software upgrade completes.

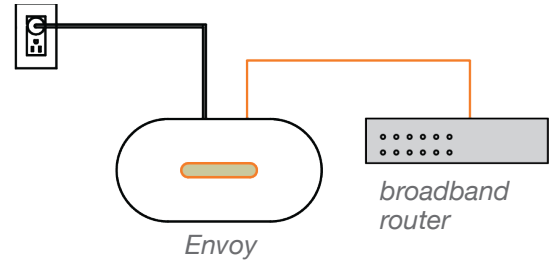

Warning: Do not remove power from the Envoy if the LCD displays: “Upgrading. . . Do Not Unplug.”

3

Position the Enphase Engage™ Cable

- Plan the cable length to allow drop connectors on the Engage Cable align to with each PV module. Allow extra length for slack, cable turns and any obstructions.
- Cut a length of Engage Cable to meet your planned needs.
- Lay out the cabling along the installed racking for the AC branch circuit.

4

Install an AC Junction Box

- Install an appropriately rated, off-the-shelf junction box at a suitable location on the racking.
- Provide an AC connection from the AC junction box back to the electricity network connection using equipment and practices as required by local jurisdictions.

See notes in **Step Details**.

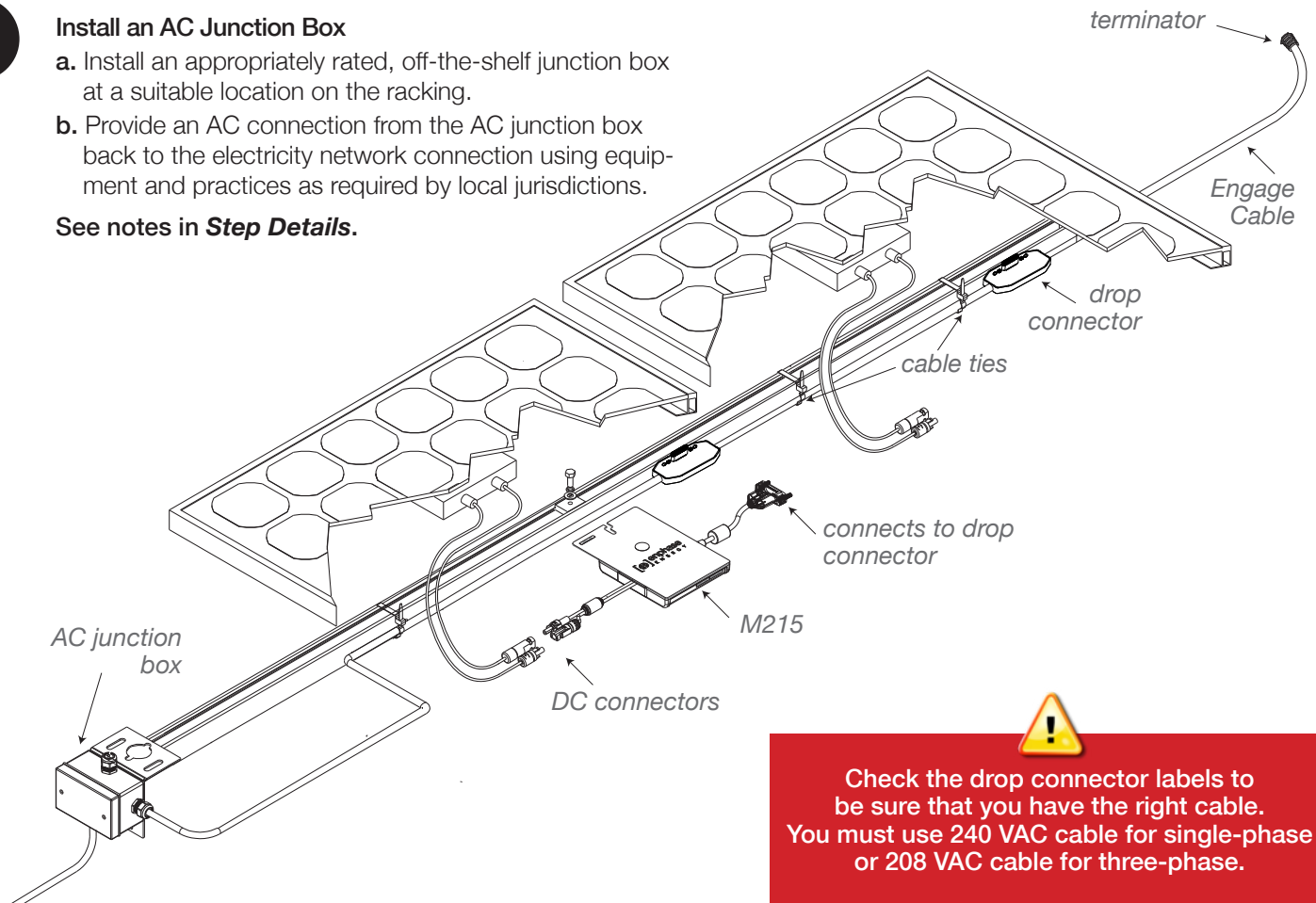

Check the drop connector labels to be sure that you have the right cable. You must use 240 VAC cable for single-phase or 208 VAC cable for three-phase.

M215 Microinverter Quick Install Guide

5 Attach the Microinverters to the PV Racking

- a. Mark the approximate centers of each PV module on the PV racking. **See notes in Step Details.**

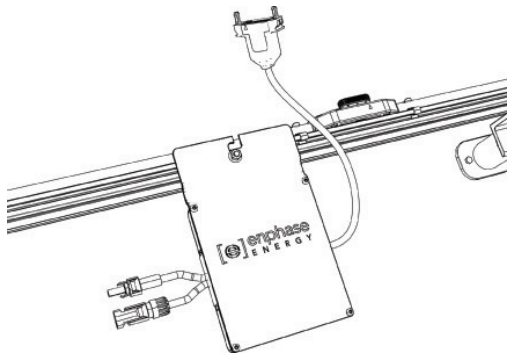

- b. Mount the microinverter under the PV module, away from rain and sun. Do not mount the microinverter in a position that allows long-term exposure to direct sunlight or in a vertical orientation that allows water to collect in the DC connector recess.
- c. Torque the microinverter fasteners as follows. Do not over torque:
- 5 N m (45-50 in-lbs) for 6 mm (1/4") hardware
 - 9 N m (80-85 in-lbs) for 8 mm (5/16") hardware

6 Dress the Cable

- a. Attach the cabling to the rack using cable clips or tie wraps.

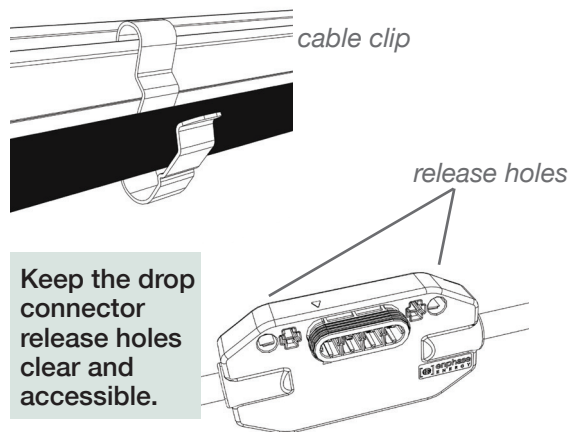

- b. Dress any excess cabling in loops so that it does not contact the roof.

7 Connect the Microinverters

- a. Remove and discard the temporary shipping cap from the cable connector and connect the microinverter. Listen for two clicks as the connectors engage.

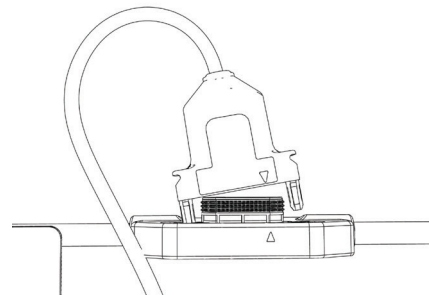

- b. Cover any unused connectors with Enphase Sealing Caps. Listen for two clicks as the connectors engage. **See notes in Step Details.**

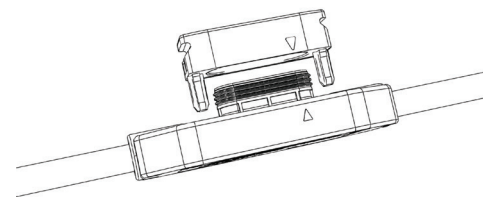

Do not use shipping caps to cover unused connectors. The shipping cap does not provide an adequate environmental seal.

NOTE: Enphase integrated ground microinverters meet the requirements of NEC 690.35. Because the DC circuit is isolated and insulated from ground, the M215-60-2LL-xxx-IG does not require a GEC. Ground fault protection (GFP) is integrated into the microinverter. For details, refer to “[Microinverters with Integrated Ground](#)” at <http://www.enphase.com/support>.

8**Terminate the Unused End of the Cable**

- a. Remove 60 mm (2.5") of the cable sheath from the conductors.

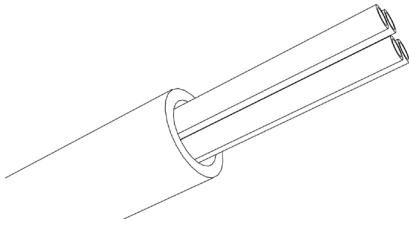

- b. Check that all terminator parts are present.

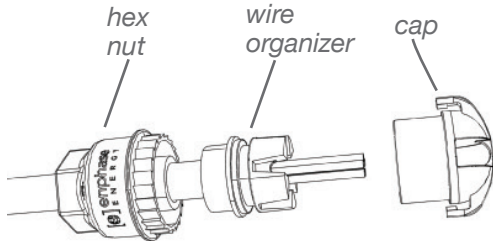

- c. Slide the hex nut onto the cable.
 d. Insert the cable end all the way into the wire organizer (up to the stop).
 e. Attach the cap.

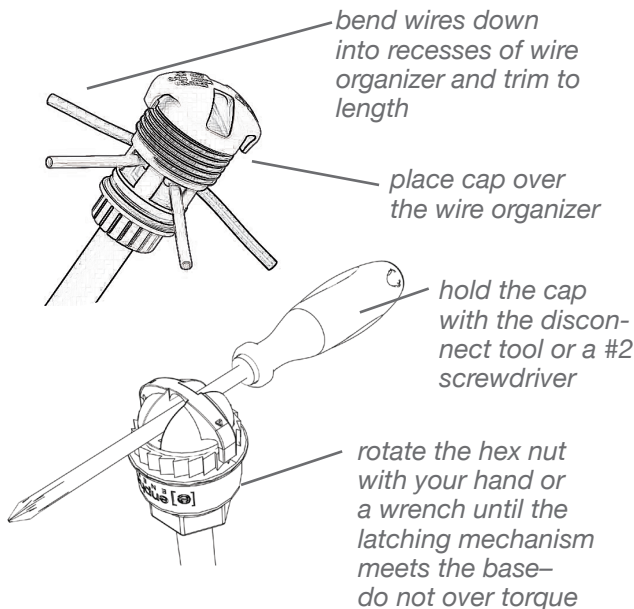

- f. Attach the terminated cable end to the PV racking with a cable clip or tie wrap.



Never unscrew the hex nut. This action can twist and damage the cable.

9**Connect the Cable to the AC Junction Box**

Connect the Engage Cable into the AC branch circuit junction box. **See notes in Step Details.**

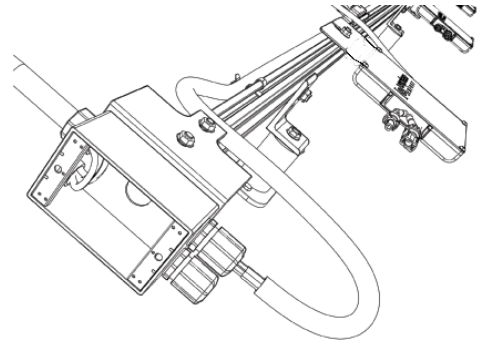
**10****Complete the Installation Map**

Build the system map manually, or use the ArrayGun feature from the Enphase Installer Toolkit to easily build and configure a system. For more information, refer to <http://enphase.com/products/arraygun>.

To manually build the Installation Map:

- a. Peel the removable serial number label from each microinverter and affix it to the respective location on the installation map included with this guide.
 b. Peel the label from the Envoy and affix it to the installation map.

- c. Log in to Enlighten.
 d. Scan the installation map and upload it to the System Activation form online.

- e. Use Array Builder to create the virtual array using the installation map as your reference.

- f. Refer to the Array Builder demo at <http://enphase.com/support/videos>.

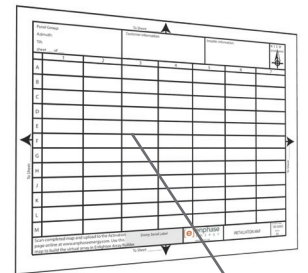

affix serial number labels

11**Connect the PV Modules**

- a. Mount the PV modules above the microinverters.
 b. Connect the DC leads of each PV module to the DC input connectors of their corresponding microinverter.

The status LED on the underside of each M215 lights green six seconds after DC power is applied. It remains lit solid for two minutes, followed by six green blinks.

After that, red blinks indicate that no grid is present. This is because the AC circuit is not yet energized.

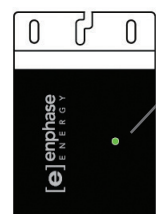

status LED

12

Energize the System

- a. If applicable, turn ON the AC disconnect or circuit breaker for the branch circuit.
- b. Turn ON the main utility-grid AC circuit breaker. Your system will start producing power **after a five-minute wait time.**

13

Use the Envoy to Complete System Setup

Refer to the to the *Envoy Quick Install Guide* for details on the following steps:

- a. An automatic device scan runs for eight hours after the Envoy is installed. If this scan has expired, start a new scan:
 - Press and hold the Envoy menu button (on the right side of the Envoy).
 - Release the menu button when the LCD screen displays **Enable Device Scan.**
- b. Use the Envoy menu button to select **Enable Communication Check.** Ensure at least three level bars show on the LCD.
- c. When all devices are detected, stop the scan. To do this, use the Envoy menu button to select **Disable Device Scan.**

Envoy menu button (rear view)

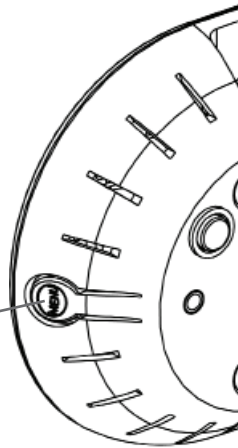

Step Details

3

NOTE: Verify that AC voltage at the site is within range:

240 Volt AC Single-Phase		208 Volt AC Three-Phase	
L1 to L2	211 to 264 VAC	L1 to L2 to L3	183 to 229 VAC
L1, L2, to N	106 to 132 VAC	L1, L2, L3 to N	106 to 132 VAC

WARNING: Only use electrical system components approved for wet locations.

WARNING: Do not exceed the maximum number of microinverters in an AC branch circuit as listed in the table below. Each branch circuit must be protected by a dedicated circuit breaker of 20 A or less.

Service type	Max M215s per branch
240 VAC single-phase	17
208 VAC three-phase	25

WARNING: Size the AC wire gauge to account for voltage drop for both the branch circuit and all upstream conductors leading back to the PCC. See **Circuit Calculations for M215** at <http://www.enphase.com/support>.

4

DANGER: ELECTRIC SHOCK HAZARD. THE DC CONDUCTORS OF THIS PHOTOVOLTAIC SYSTEM ARE UNGROUNDED AND MAY BE ENERGIZED.

WARNING: Allow a minimum of 1.9 cm (0.75") between the roof and the microinverter. Also allow 1.3 cm (0.50") between the back of the PV module and the top of the microinverter.

NOTE: Torque the microinverter fasteners to the values shown. Do not over torque:

- 1/4" mounting hardware – 5 N m (45-50 in-lbs)
- 5/16" mounting hardware – 9 N m (80-85 in-lbs)

Using a power screwdriver is not recommended due to the risk of thread galling.

NOTE: The AC output neutral is not bonded to ground inside the microinverter.

6

WARNING: Install sealing caps on all unused AC connectors as these become live when the system is energized by the utility. The IP67-rated sealing caps are required for protection against moisture ingress.

NOTE: To remove a sealing cap, you must use the Enphase disconnect tool or a #3 Phillips screwdriver.

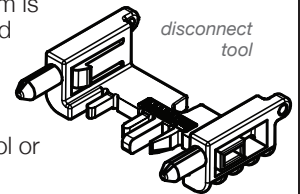

8

NOTE: The Engage Cable uses the following wiring scheme.

240 Volt AC Single-Phase Wires	208 Volt AC Three-Phase Wires
Black – L1	Black – L1
Red – L2	Red – L2
White – Neutral	Blue – L3
Green – Ground	White – Neutral
	Green – Ground

NOTE: The green wire acts as equipment ground (EGC).

Enphase Energy, Inc.
1420 N. McDowell Blvd.
Petaluma, CA 94954
USA

info@enphaseenergy.com
<http://www.enphase.com>



To Sheet: _____ ↗

Panel Group: Azimuth: Tilt: sheet ____ of ____	Customer information:					Installer information:					N S E W (circle one) 
1	2	3	4	5	6	7					

A												
B												
C												
D												
E												
F												
G												
H												
J												
K												
L												
M												

↖ To Sheet: _____

To Sheet: _____ ↘

Scan completed map and upload it to Enphase. Click "Add a New System" at <https://enlighten.enphaseenergy.com>. Use this map to build the virtual array in Enlighten's Array Builder.

Envoy Serial Label



INSTALLATION MAP

DOCUMENT NUMBER
140-00003
REVISION
04

↗ To Sheet: _____