



International Series GFX Inverter/Charger

GFX1312E

GFX1424E

GFX1448E

Installation Manual



About OutBack Power Technologies

OutBack Power Technologies is a leader in advanced energy conversion technology. Our products include true sine wave inverter/chargers, maximum power point tracking charge controllers, and system communication components, as well as circuit breakers, batteries, accessories, and assembled systems.

Contact Information

Telephone: +1.360.435.6030
+1.360.618.4363 (Technical Support)
+1.360.435.6019 (Fax)

Address: North America
5917 – 195th Street N.E., #7
Arlington, WA 98223 USA

Address: Sales, Marketing, & Warranty
6115 – 192nd Street NE
Arlington, WA 98223 USA

E-mail: Support@outbackpower.com

Web Site: www.outbackpower.com

Disclaimer

UNLESS SPECIFICALLY AGREED TO IN WRITING, OUTBACK POWER TECHNOLOGIES:

(a) MAKES NO WARRANTY AS TO THE ACCURACY, SUFFICIENCY OR SUITABILITY OF ANY TECHNICAL OR OTHER INFORMATION PROVIDED IN ITS MANUALS OR OTHER DOCUMENTATION.

(b) ASSUMES NO RESPONSIBILITY OR LIABILITY FOR LOSS OR DAMAGE, WHETHER DIRECT, INDIRECT, CONSEQUENTIAL OR INCIDENTAL, WHICH MIGHT ARISE OUT OF THE USE OF SUCH INFORMATION. THE USE OF ANY SUCH INFORMATION WILL BE ENTIRELY AT THE USER'S RISK.

Warranty Summary

OutBack Power Technologies warrants that the products it manufactures will be free from defects in materials and workmanship for a period of five (5) years subject to the conditions set forth in the warranty detail, found in the *International Series GFX Operator's Manual*.

OutBack Power Technologies cannot be responsible for system failure, damages, or injury resulting from improper installation of their products.

Notice of Copyright

International Series GFX Installation Manual © February 2012 by OutBack Power Technologies. All Rights Reserved.

Trademarks

OutBack Power is a registered trademark of OutBack Power Technologies.

Date and Revision

February 2012, Revision B

Part Number

900-0111-01-00 Rev B (for firmware revision 002.094.xxx)

Important Safety Instructions





READ AND SAVE THESE INSTRUCTIONS!

This manual contains important safety instructions for the International Series GFX inverters. Read all instructions and cautionary markings on the inverter and on any accessories or additional equipment included in the installation. Failure to follow these instructions could result in severe shock or possible electrocution. Use extreme caution at all times to prevent accidents.

Audience

These instructions are for use by qualified personnel who meet all local and governmental code requirements for licensing and training for the installation of electrical power systems with AC and DC voltage up to 600 volts.

Symbols Used

Symbol	Description
	Ground/PE
	AC Current
	DC Current
	Single-Phase
	Sine Wave



WARNING: Hazard to Human Life

This type of notation indicates that the hazard could be harmful to human life.



CAUTION: Hazard to Equipment

This type of notation indicates that the hazard may cause damage to the equipment.



IMPORTANT:

This type of notation indicates that the information provided is important to the installation, operation and/or maintenance of the equipment. Failure to follow the recommendations in such a notation could result in voiding the equipment warranty.

Important Safety Instructions

Definitions

The following is a list of initials, terms, and definitions used with this product.

Table 1 Terms and Definitions



Term	Definition
AC	Alternating Current; refers to voltage produced by the inverter, utility grid, or generator
AGS	Advanced Generator Start
AUX	Inverter's 12-volt auxiliary output
CE	<i>Conformité Européenne</i> ; French for "European Conformity"; a marking on OutBack products indicating that they meet certain European Union requirements
DC	Direct Current; refers to voltage produced by the batteries or renewable source
DCC	DC Cover
DVM	Digital Voltmeter
GFDI	Ground Fault Detector Interruptor; a safety device for PV systems
Grid-interactive, grid-intertie, grid-tie	Utility grid power is available for use and the inverter is a model capable of returning (selling) electricity back to the utility grid
GND	Ground; a permanent conductive connection to earth for safety reasons; also known as Chassis Ground, Protective Earth, and PE
LED	Light-Emitting Diode; refers to indicators used by the inverter and the system display
NEU	AC Neutral; also known as Common
Off-grid	Utility grid power is not available for use
On-grid	Utility grid power is available for use (does not imply grid-interactive capability)
PV	Photovoltaic
RE	Renewable Energy
RTS	Remote Temperature Sensor; accessory that measures battery temperature for charging
System display	Remote interface device (such as the MATE or MATE3), used for monitoring, programming and communicating with the inverter; also called "remote system display"
Utility grid	The electrical service and infrastructure supported by the electrical or utility company; also called "mains", "utility service", or "grid"

General Safety



WARNING: Limitations on Use



This equipment is NOT intended for use with life support equipment or other medical equipment or devices.

	<p>CAUTION: Equipment Damage</p> <p>Only use components or accessories recommended or sold by OutBack Power Technologies or its authorized agents.</p>
	<p>IMPORTANT:</p> <p>Do not attempt to install this equipment if it appears to be damaged in any way. See the Warranty section for instructions on returning the equipment.</p>



Personal Safety

	<p>WARNING: Personal Injury</p> <ul style="list-style-type: none"> ➤ This equipment weighs in excess of 22 kg (49 lb). Use safe lifting techniques when lifting this equipment as prescribed by local codes. ➤ Use standard safety equipment such as safety glasses, ear protection, steel-toed safety boots, safety hard hats, etc., as prescribed by local codes when working on this equipment. ➤ Use standard safety practices when working with electrical equipment. (Remove all jewelry, use insulated tools, wear cotton clothing, etc.) ➤ Never work alone when installing or servicing this equipment. Have someone nearby that can assist if necessary.
---	---



Inverter Safety

	<p>WARNING: Lethal Voltage</p> <ul style="list-style-type: none"> ➤ Review the system configuration to identify all possible sources of energy. Ensure ALL sources of power are disconnected before performing any installation or maintenance on this equipment. Confirm that the terminals are de-energized using a validated voltmeter (rated for a minimum 1000 Vac and 1000 Vdc) to verify the de-energized condition. ➤ Do not perform any servicing other than that specified in the installation instructions unless qualified to do so, or have been instructed to do so by OutBack Power Technologies Technical Support personnel.
	<p>WARNING: Burn Hazard</p> <p>Internal parts can become hot during operation. Do not remove the cover during operation or touch any internal parts. Be sure to allow sufficient time for internal parts to cool down before attempting to perform any maintenance.</p>
	<p>WARNING: Fire Hazard</p> <ul style="list-style-type: none"> ➤ Do not place combustible or flammable materials within 3.7 m (12 feet) of the equipment. ➤ This product contains relays with moving parts and is not ignition-protected. ➤ Ensure AC, DC, and ground cable sizes conform to local codes. See pages 18 through 21 for minimum size requirements. Ensure all conductors are in good condition. Do not operate the unit with damaged or substandard cabling.

Important Safety Instructions

	<p>CAUTION: Equipment Damage</p> <p>When connecting cables from the inverter to the battery terminals, ensure the proper polarity is observed. Connecting the cables incorrectly can damage or destroy the equipment and void the product warranty.</p>
	<p>CAUTION: Equipment Damage</p> <ul style="list-style-type: none">➤ Thoroughly inspect the equipment prior to energizing. Verify that no tools or equipment have been inadvertently left behind.➤ Ensure clearance requirements are strictly enforced. Keep all vents clear of obstructions that can prevent proper air flow around, or through, the unit.➤ Sensitive electronics inside the equipment can be destroyed by static electricity. Be sure to discharge any static electricity before touching the equipment and wear appropriate protective gear.

Battery Safety

	<p>WARNING: Explosion, Electrocution, or Fire Hazard</p> <ul style="list-style-type: none">➤ Use the battery types recommended by OutBack Power Technologies. Follow the battery manufacturer's recommendations for installation and maintenance.➤ Ensure the cables are properly sized. Failure to size the cables properly can result in a fire hazard.➤ Ensure clearance requirements are strictly enforced around the batteries.➤ Ensure the area around the batteries is well ventilated and clean of debris.➤ Never smoke, or allow a spark or flame near, the batteries.➤ Always use insulated tools. Avoid dropping tools onto batteries or other electrical parts.➤ Keep plenty of fresh water and soap nearby in case battery acid contacts skin, clothing, or eyes.➤ Wear complete eye and clothing protection when working with batteries. Avoid touching bare skin or eyes while working near batteries.➤ If battery acid contacts skin or clothing, wash immediately with soap and water. If acid enters the eye, immediately flood it with running cold water for at least 20 minutes and get medical attention as soon as possible.➤ Never charge a frozen battery.➤ Insulate batteries as appropriate against freezing temperatures. A discharged battery will freeze more easily than a charged one.➤ If a battery must be removed, always remove the grounded terminal from the battery first. Make sure all devices are de-energized or disconnected to avoid causing a spark.➤ If a remote or automatic generator control system is used, disable the starting circuit and/or disconnect the generator from its starting battery while performing maintenance to prevent accidental starting.
	<p>IMPORTANT:</p> <p>Baking soda neutralizes lead-acid battery electrolyte. Vinegar neutralizes NiCad and NiFe battery electrolyte. Have a supply of either substance readily available if using these types of batteries.</p>

Regulatory Specifications

See the *International Series GFX Inverter/Charger Operator's Manual* for all specifications and compliance information.

Additional Resources

This product is required to be installed according to pertinent safety codes and standards. Depending on the nature of the installation, it may be highly recommended to consult these resources.

- International Building Code (IBC), Current Edition
- Any local or national electrical code documents

Recycling Information



IMPORTANT: Recycle Electronics and Batteries

Batteries are considered hazardous waste and must be recycled according to local jurisdiction. Inverters and other electronics contain metals and plastics that should also be recycled. The following web sites and phone numbers provide additional information for recycling electronic products and batteries.

EuroRecycle.net, Europe

The following web site provides general information about recycling in Europe. It also provides a list of companies and organizations that provide recycling information or assistance.

- Web site: <http://euro.recycle.net>
E-mail: <http://euro.recycle.net/cgi-bin/feedback1.cgi?w=27>
(This is an online form providing a means to contact the owners of the web site.)

Natural Resources Canada

- Web site: <http://www.nrcan-rncan.gc.ca/mms-smm/busi-indu/rec-rec-eng.htm>
Address: 580 Booth, Ottawa, ON K1A 0E8
Phone: +1.613.995.0947
TTY: +1.613.996.4397
(Phone and TTY: Monday to Friday, 8:30 a.m. to 4:30 p.m. ET)

Office of Waste Management, Canada

- Web site: http://www.portaec.net/library/recycling/recycling_in_canada.html
Address: Office of Waste Management
Conservation and Protection
Environment Canada
Ottawa, Ontario K1A 0H3
Phone: +1.819.997.2800

Important Safety Instructions

National Institute of Recyclers, Mexico

Web site: <http://www.inare.org.mx/>
Email: a57841279@prodigy.net.mx, margarita@inare.org.mx
Phone: +1.55.57.85.9160
Fax: +1.55.57.84.1279

Earth 911, USA

Web site: <http://www.Earth911.com>
Address: 14646 N. Kierland Blvd., Suite 100
Scottsdale, AZ 85254
Phone: +1.480.337.3025 (direct)

OurEarth.org, USA

There is a place on the web site for contacting OurEarth.org using email. No direct email address is provided.

Web site: <http://www.ourearth.org>
Address: P.O. Box 62133
Durham, NC 27715
Phone: +1.410.878.6485

Environmental Protection Agency, USA

Web site: <http://www.epa.gov/wastes/conserves/materials/ecycling/donate.htm>
Address: EPA USA
Office of Resource Conservation and Recovery (5305P)
1200 Pennsylvania Avenue NW
Washington, DC 20460

Keep America Beautiful, USA

Web site: <http://www.kab.org/>
Email: info@kab.org
Address: 1010 Washington Boulevard
Stamford, CT 06901
Phone: +1.203.659.3000 (Main number)
Fax: +1.203.659.3001



Table of Contents

Important Safety Instructions	1
Audience	1
Symbols Used	1
Definitions.....	2
General Safety	2
Personal Safety	3
Inverter Safety	3
Battery Safety.....	4
Regulatory Specifications.....	5
Additional Resources	5
Recycling Information	5
Introduction.....	9
Welcome to OutBack Power Technologies.....	9
Models.....	9
Components and Accessories	10
Planning	11
Applications	11
Renewable Energy.....	12
Battery Bank.....	12
Generator.....	12
Installation	15
Location and Environmental Requirements.....	15
Dimensions.....	15
Tools Required.....	16
Mounting.....	16
Terminals and Ports.....	17
Grounding.....	18
DC Wiring	19
AC Wiring.....	21
AC Sources.....	22
Accessory Wiring	23
AUX Wiring	24
Automatic Generator Start (AGS)	25
Single-Inverter AC Installations.....	27
Multiple-Inverter AC Installations (Stacking).....	28
Stacking Connections.....	28
Parallel Stacking (Dual-Stack and Larger)	29
Three-Phase Stacking	31
Functional Test.....	33
Index	35

List of Tables

Table 1	Terms and Definitions	2
Table 2	Components and Accessories	Error! Bookmark not defined.
Table 3	Ground Conductor Size and Torque Requirements	Error! Bookmark not defined.
Table 4	DC Conductor Size and Torque Requirements	Error! Bookmark not defined.
Table 5	AC Conductor Size and Torque Requirements.....	Error! Bookmark not defined.

List of Figures

Figure 1	International Series GFX Inverter/Charger.....	9
Figure 2	GFX Components	10
Figure 3	Applications (Example)	11
Figure 4	Dimensions	15
Figure 5	Terminals, Ports, and Features.....	17
Figure 6	DC Ground Lug.....	18
Figure 7	AC Ground Terminals.....	18
Figure 8	Battery Terminal Covers.....	19
Figure 9	Required Order of Battery Cable Hardware.....	20
Figure 10	AC Terminals.....	21
Figure 11	Multiple AC Sources	22
Figure 12	Accessory Connections	23
Figure 13	ON/OFF Jumper and Connections.....	23
Figure 14	AUX Connections for Vent Fan (Example).....	24
Figure 15	AUX Connections for Diversion (Example)	24
Figure 16	Two-Wire Generator Start (Example)	Error! Bookmark not defined.
Figure 17	Three-Wire Generator Start (Example)	Error! Bookmark not defined.
Figure 18	Single-Inverter Wiring.....	27
Figure 19	OutBack HUB4 and MATE.....	28
Figure 20	Example of Parallel Stacking Arrangement (Three Inverters).....	29
Figure 21	Parallel Wiring (Four Inverters).....	30
Figure 22	Example of Three-Phase Stacking Arrangement (Three Inverters)	31
Figure 23	Three-Phase Wiring (Three Inverters)	32



Introduction

Welcome to OutBack Power Technologies

Thank you for purchasing the OutBack International Series GFX Inverter/Charger. This product offers a complete power conversion system between batteries and AC power. It can provide backup power or complete off-grid service.

- Battery-to-AC inverting which delivers 230 Vac at 50 Hz
- AC-to-battery charging
- Rapid transfer between AC source and inverter output with minimal delay time
- Inverter load support for a small AC source
- 12-, 24-, and 48-volt inverters
- Wattages from 1.3 kVA to 1.4 kVA
- Stackable in parallel and three-phase configurations
- Uses energy from PV, wind, and other renewable sources if appropriate controllers are used
- Grid-interactive capable
- CE Compliant for off-grid use



Figure 1 International Series GFX Inverter/Charger

Models

The International Series GFX inverters are designed for harsher environments and can survive casual exposure to the elements. However, enclosed protection is still recommended. These inverters have an internal fan, but do not use outside air for cooling.

- GFX1312E (1.3 kVA output, 12 Vdc)
- GFX1424E (1.4 kVA output, 24 Vdc)
- GFX1448E (1.4 kVA output, 48 Vdc)

Inverter model numbers use the following naming conventions.

- Grid-interactive models (all models in this series) begin with the letter G. For example, model GFX1424E is grid-interactive; model VFX3524 is not.
- The model number includes "FX" as the inverter series.
- The first two digits show the wattage of that model. For example, "GFX**13**12E" is 1300 watts.
- The second pair of digits shows the inverter's nominal DC voltage. For example, "GFX14**24**E" is 24 volts.
- The letter "E" at the end of the model number indicates an inverter that can deliver 230 Vac at 50 Hz.

Components and Accessories

Table 2 Components and Accessories

Installed Components	Included in Box
Battery Terminal Cover, red	<i>GFX Series Installation Manual</i> (this book)
Battery Terminal Cover, black	<i>GFX Series Operator's Manual</i>
AC Conduit Plate	"WARNING ELECTRICAL SHOCK" sticker
DC Cover (DCC)	Remote Temperature Sensor (RTS)
	Silicone Grease Packet

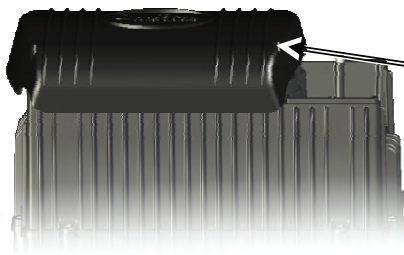

DCC (DC COVER)

Covers the DC terminal area and provides space to mount other components such as a DC current shunt.



AC CONDUIT PLATE

Connects to AC conduit for installations which do not utilize OutBack's optional FLEXware conduit boxes.

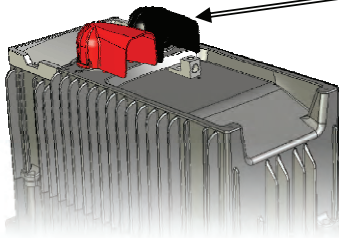

BATTERY TERMINAL COVER

Protects terminals from accidental contact. Made of stiff plastic with a snap-on design.

Always keep covers installed during normal operation.

When required, remove covers carefully using a flat-blade screwdriver inserted into the slots on the sides of each cover.

The DCC does not replace the battery terminal covers; they must be installed in addition to the DCC.

Figure 2 GFX Components



Planning

Applications

The International Series GFX inverters are intended for both off-grid and grid-interactive applications. These models are designed to use a battery bank to store energy. They can work in conjunction with photovoltaic (PV) panels to harvest solar energy, as well as wind turbines and other renewable sources. These sources charge the battery, which in turn is used by the inverter.

In grid-interactive applications, the grid is the primary source of power to run the loads. When excess PV (or another renewable energy source) is available from the batteries, the inverter supports those loads with the PV. When the PV exceeds the load requirements, the inverter sells that excess power back through its input, to the utility grid. When the utility grid is not available, the inverter takes over to run the loads with PV and energy stored in the battery bank.

If the inverter is used as the primary source, the grid power will be used when the batteries have been drained. In this situation, the AC power, PV harvest, or other renewable energy can be used to recharge the battery bank.

In off-grid applications, the inverter can use the harvested energy from the battery bank as the primary power source. An AC generator can also be connected to support the system when required.

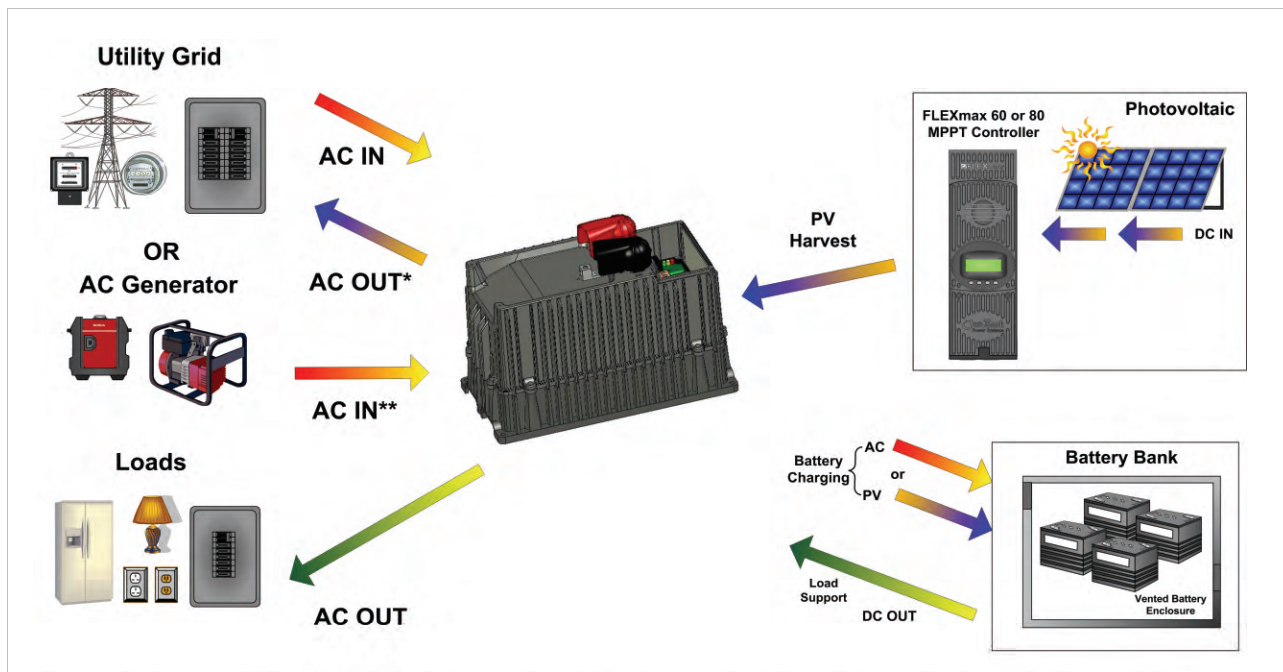

*Excess AC power not being used by the AC loads. Uses bidirectional AC input for sell-back. Requires a GFX Inverter/Charger programmed for a grid-interactive application.

**AC power used for input only. GFX inverter should have its grid-interactive feature disabled when using a generator.

Figure 3 Applications (Example)

Renewable Energy

The inverter cannot connect directly to PV, wind turbines, or other renewable sources. The batteries are the inverter's primary source of power. However, if these sources are used to charge the batteries, the inverter can use their energy by drawing it from the batteries.

The renewable source is always treated as a battery charger, even if all of its power is used immediately. The renewable source must have a charge controller or some way to prevent overcharging. OutBack Power's FLEXmax charge controllers can be used for this purpose, as can other products.

Battery Bank



IMPORTANT:

Battery charger settings need to be correct for a given battery type. Always follow battery manufacturer recommendations. Making incorrect settings, or leaving them at factory default settings, may cause the batteries to be undercharged or overcharged.

When planning a battery bank, consider the following:

- The GFX inverters work best with lead-chemistry batteries intended for deep discharge. These include batteries for marine, golf-cart, and forklift applications. They also include gel-cell batteries and absorbed glass-mat (AGM) batteries. OutBack Power recommends the use of batteries designed specifically for renewable energy applications. Automotive batteries are strongly discouraged and will have a short life if used in inverter applications. Nickel-based batteries are discouraged due to limitations in the GFX charger. Lithium-based batteries and other advanced battery technologies may require special considerations. Please contact OutBack Technical Support at **+1.360.618.4363** before implementing advanced battery technologies.
- These inverters are designed to work with 12-, 24-, or 48-volt battery banks, depending on inverter model. Before constructing a battery bank, check the inverter model and confirm nominal battery voltage.
- A vented enclosure for the battery bank may be required by electric code and is recommended in most cases for safety reasons.



CAUTION: Hazard to Equipment

Batteries can emit vapors which are corrosive over long periods of time. Installing the inverter in the battery compartment may cause corrosion which is not covered by the product warranty. (Sealed batteries may be an exception.)

Generator

The GFX inverters can work with any generator that delivers clean 230 Vac at 50 Hz. Inverters stacked for three-phase output can work with three-phase generators.

- The inverter/charger can provide a start signal to control an automatic-start generator. If automatic generator starting is required, the generator must be an electric-start model with automatic choke and two-wire start capability. For other configurations, additional equipment may be required.
- In all cases, the inverter may need to be programmed according to the specifications of the generator and the requirements of the system, using a remote system display. (See the *International Series GFX Operator's Manual* and the system display manual.) Parameters to be programmed may include generator size, automatic starting requirements, and potential fluctuations in generator AC voltage.



Installation

Location and Environmental Requirements

The International Series GFX inverters can be located outdoors, but OutBack recommends that they be protected from the environment.

- If protected from the environment, the inverter can mount in any position or orientation. If exposed to the environment, it cannot be placed upside-down, to ensure that water will not accumulate under the DC cover. (It can be mounted in any other position or orientation.)
- For installations where the inverter may be exposed to water spray, the inverter must be mounted either with the base down (shelf mounting) or with the AC wiring compartment facing down (wall mounting). If mounted with the base down, water cannot be allowed to accumulate around the inverter's base. There is a drainage system on the base of the inverter to dispel condensation. If submerged, water can enter this drain and cause failure.
- The inverter will perform more efficiently in locations offering plenty of air circulation. The recommended minimum clearance is 5 to 10 cm (2 to 4 inches) on all sides of the inverter.
- The inverter will function to all of its specifications if operated in a range of 0°C to 50°C (32°F to 122°F). Note that the inverter's maximum wattage will derate in temperatures above 25°C.
- The inverter will function, but will not necessarily meet its specifications, if operated in a temperature range of -40°C to 60°C (-40°F to 140°F). This is also the allowable temperature range for storage. (The specifications are listed in the *International Series GFX Operator's Manual*.)

Dimensions

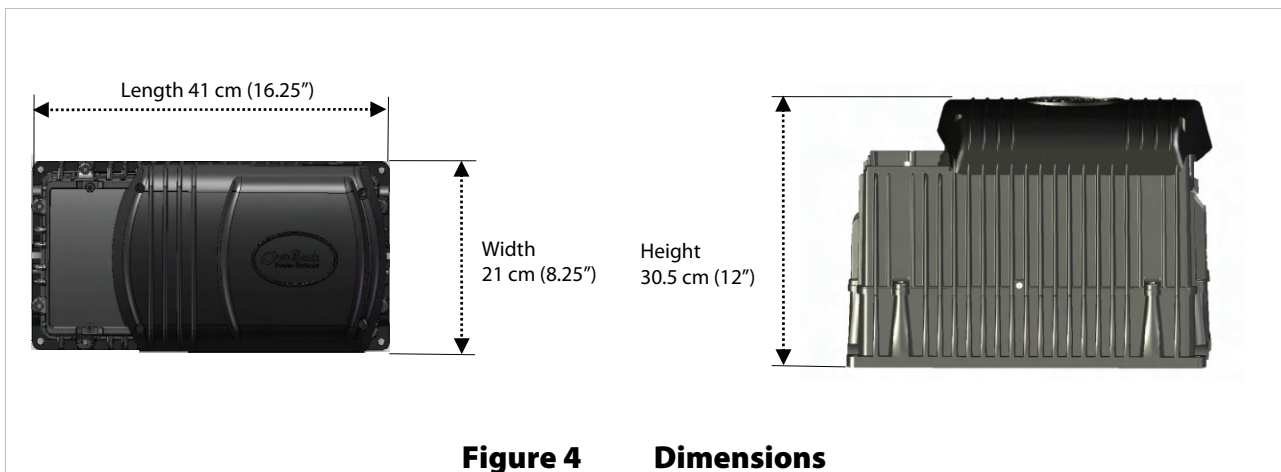

Tools Required

- Wire cutters/strippers
- Torque wrenches
- Assorted insulated screwdrivers
- DVM or Voltmeter

Mounting

- It is easier for two people to install the GFX inverter due to its weight.
- The unit has four mounting holes, one in each corner. Use fasteners in all four corners for a secure installation.
- Due to the variance in other mounting methods, OutBack only endorses the use of FLEXware or previous versions of its mounting plate. Use M6 x 20 mm machine screws, one per corner, to attach the inverter to the mounting plate. Follow the instructions with each mounting system.



IMPORTANT:

Use correct fasteners to secure the GFX inverter to the mounting surface, regardless of the type of surface. OutBack cannot be responsible for damage to the product if it is attached with inadequate fasteners.

- Mount and secure each component before attaching any wiring.
- When the inverter is used with other metal housings, make sure that all housings are grounded appropriately. (See the grounding instructions on page 18.) Grounding other housings may involve metal-to-metal contact, or separate ground wires.
- If using an OutBack FLEXware Mounting Plate, avoid large air gaps behind the plate. These can result in louder mechanical noise during heavy inverting or charging. Mount the plate on a flat, solid mounting surface.

Terminals and Ports

DC TERMINALS: Connect to battery cables and DC system. See page 19 for instructions.

DC and AC GROUND TERMINALS: Connect to grounding system for both batteries and AC. See page 18 for instructions.

CONTROL WIRING TERMINAL BLOCK: Connects control wires for a variety of functions, including automatic generator starting. See pages 24 and 25 for instructions and the *International Series GFX Operator's Manual* for more information. The Terminal Block can be unplugged from the AC board for convenience. While installed, keep screws tight and the block itself secured tightly to the AC board to prevent malfunction.

INVERTER ON/OFF: Connects wires for a manual on/off switch to control the inverter. The jumper alongside (JP1) disables these terminals when installed (factory default). In this state, the inverter is always ON and can only be controlled by the system display. See page 23 for instructions.

AUX OUTPUT (AUX+/AUX-): Delivers 12 Vdc up to 0.7 amps (8.4 watts). The output can be switched on and off for many functions. The default function is to drive a cooling fan. See page 24 for details. See the system display manual for programming instructions.

AUX LED INDICATOR: Amber LED turns on when 12 Vdc output is present.

AC TERMINAL BLOCK: Connects AC input and output wires. See page 21 for instructions.

XCT+/XCT-: Non-operational terminals. Do not connect anything to them.

MATE and RTS PORTS: Connect the RJ45 and RJ11 plugs from the system display and Remote Temp Sensor. See page 23 for instructions. The jacks are mounted sideways. When viewed from the left side, they appear as shown below.

LED INDICATORS: Display the unit status and battery voltage. The *Operator's Manual* contains extensive descriptions of the LED functions.

- The three BATTERY LEDs (green, yellow, and red) are based on DC voltage, and provide a very general idea of battery state.
- The green INVERTER LED tells if the inverting function is on.
- The yellow AC IN LED tells if an AC source is present.
- The red ERROR LED indicates either a Warning or an Error. A Warning is an alert for a problem that is not severe enough for shutdown. An Error usually accompanies inverter shutdown. See the *Operator's Manual* for more information.

Figure 5 Terminals, Ports, and Features



WARNING: Shock Hazard

The inverter's AC output is defaulted to ON from the factory. It will deliver 230 Vac as soon as DC power is connected.

Grounding



	<p>WARNING: Shock Hazard</p> <p>The unit must be connected to a grounded, permanent wiring system. If a bond is made between neutral and ground make sure only one bond is present in the AC system at any time. Some codes require the bond to be made at the main panel only.</p>
	<p>WARNING: Shock Hazard</p> <p>For all installations, the negative battery conductor should be bonded to the grounding system at only one point. If the OutBack GFDI is present, it can provide the bond.</p>
	<p>IMPORTANT:</p> <p>OutBack products are not designed for use in a positive-grounded system. If it is necessary to build a positive-ground system with OutBack products, contact OutBack Technical Support at +1.360.618.4363 before proceeding. Additionally, consult the online forum at www.outbackpower.com/forum/, where this subject has been discussed extensively.</p>

Table 3 Ground Conductor Size and Torque Requirements

Terminal Location	Minimum Conductor Size	Torque Requirements
Chassis Ground/PE	6 mm ² (#10 AWG) or 0.009 in ²	2.8 Nm (25 in-lb)
DC Box Lug	16 mm ² (#6 AWG) or 0.025 in ²	5.1 Nm (45 in-lb)

The inverter's DC ground is a box lug located next to the negative DC battery terminal. Local codes or regulations may require the DC ground to be run separately from the AC ground. Also, if present, it will be necessary to remove the DC Cover before making the ground connection.

NOTE: The DC ground lug is electrically common with the CHASSIS GROUND/PE terminals (see below).

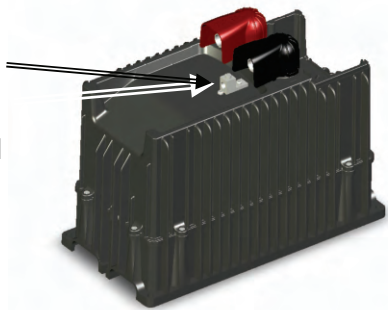
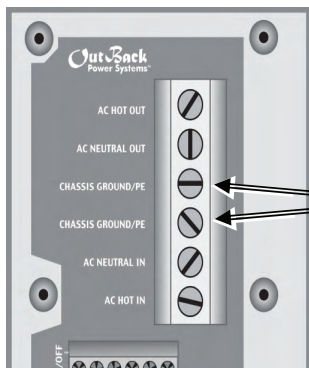

Figure 6 DC Ground Lug



The two CHASSIS GROUND/PE terminals are electrically common. If connecting to an external ground bus, only one terminal needs to be used. The other terminal may be used if connecting to a device with its own ground wire, such as a generator.

Figure 7 Chassis Ground/PE

DC Wiring



	<p>CAUTION: Equipment Damage</p> <p>Never reverse the polarity of the battery cables. Always ensure correct polarity.</p>
	<p>CAUTION: Fire Hazard</p> <p>Always install a circuit breaker or overcurrent device on each DC positive conductor to protect the DC system.</p>

Table 4 DC Conductor Size and Torque Requirements

Inverter	Nominal DC Amps (Derated 125%)	Conductor Size (Minimum)	Breaker Size (Minimum)
GFX1312E	130	70 mm ² (2/0 AWG) or 0.109 in ²	175 Adc
GFX1424E	70	70 mm ² (1/0 AWG) or 0.109 in ²	125 Adc
GFX1448E	35	50 mm ² (#1 AWG) or 0.078 in ²	100 Adc
Terminal Location		Torque Requirements	
Inverter DC Terminals		4.0 Nm (35 in-lb)	
Battery Terminals		See battery manufacturer's recommendations	

When installing DC cables:

- Make certain DC circuit breakers are turned to the off position, or fuses are removed, before proceeding.
- Note sizes in Table 4, but refer to applicable codes for absolute cable size recommendations.
- Battery positive and negative cables should be no longer than 3 meters (10 feet) each, to minimize voltage loss and other effects.
- Install all overcurrent devices on the positive cable.
- The cables listed above are for each inverter in a system. In a system with multiple inverters, each inverter requires its own cables and overcurrent devices of the size indicated.
- The inverter's battery terminal is a threaded stud which accepts a ring terminal lug. Use crimped and sealed copper ring lugs with 0.79 cm (5/16 inch) holes, or use compression lugs.
- Tie, tape, or twist cables together to reduce self-inductance. Run positive and negative cables through the same knockouts and conduit.

If present, remove the battery terminal covers. These are made of stiff plastic with a snap-on design. Remove carefully using a flat screwdriver inserted into the slots on the sides of each cover.

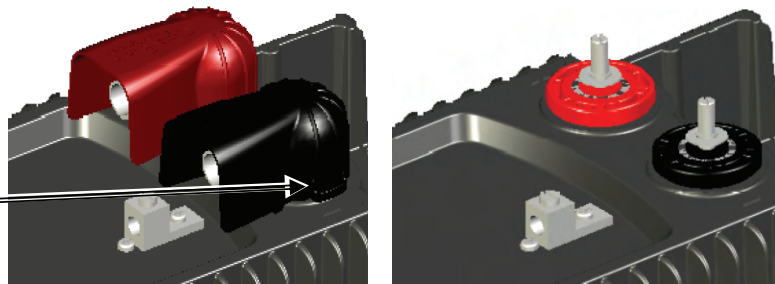

Figure 8 Battery Terminal Covers

Installation

Install battery cable lug, nuts, and washers in the order illustrated. The battery cable lug should be the first item installed on the stud. It should make solid contact with the mounting surface. Do not install hardware in a different order than shown.

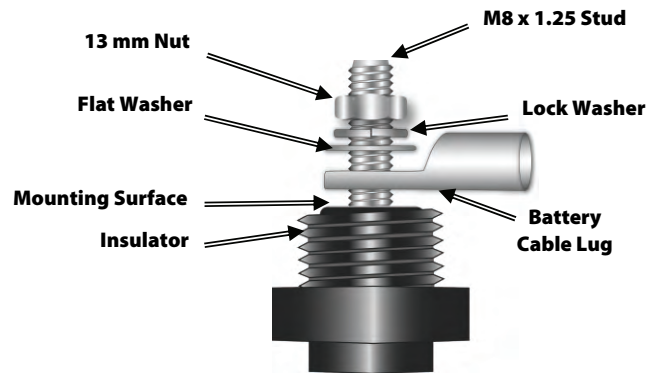

Figure 9 Required Order of Battery Cable Hardware



CAUTION: Fire Hazard

Never install extra washers or hardware between the mounting surface and the battery cable lug. The decreased surface area can build up heat.

AC Wiring

Table 5 AC Conductor Size and Torque Requirements

Conductor Size Recommendation	Torque Requirements
Minimum 6 mm ² (#10 AWG) or 0.009 in ²	4.0 Nm (35 in-lb)

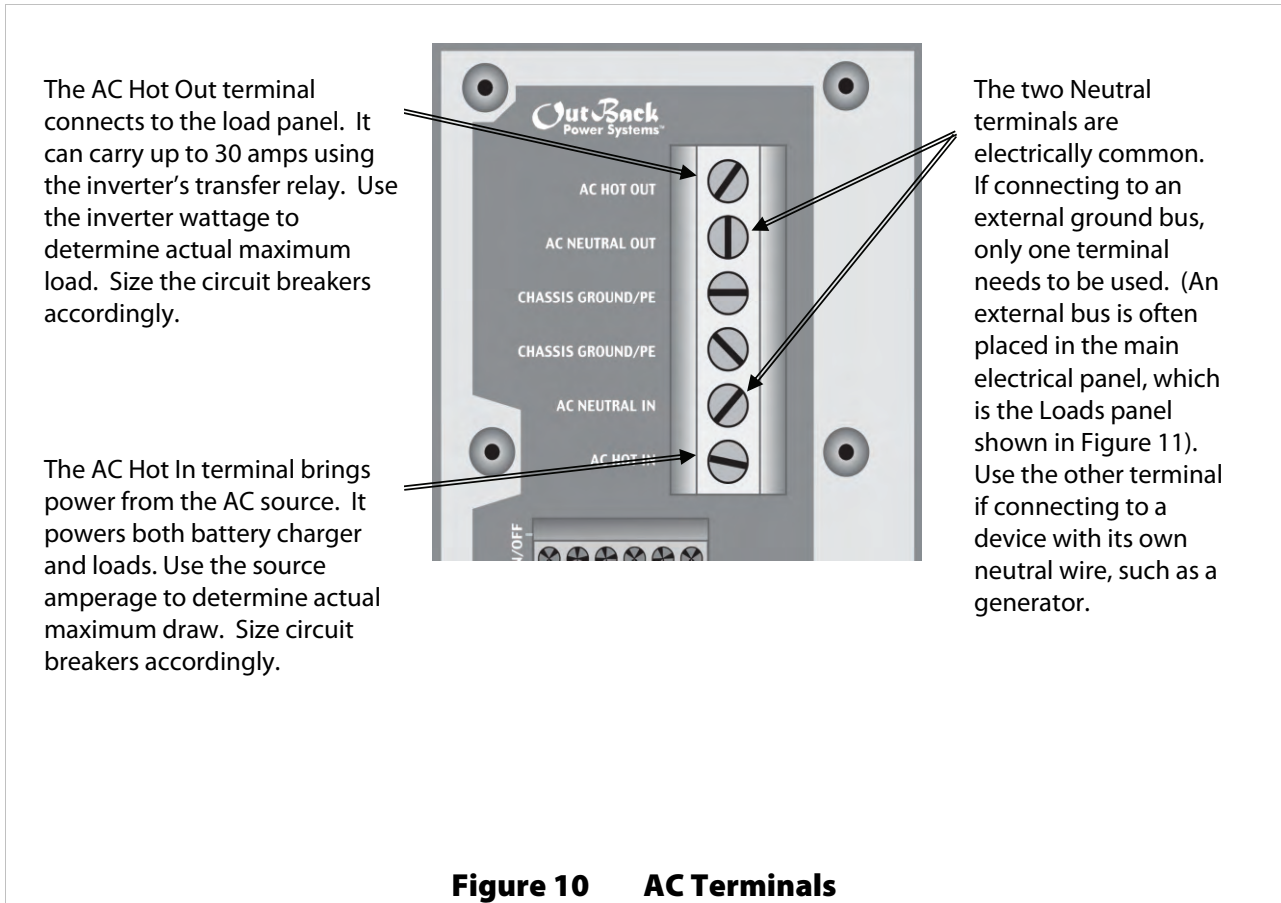
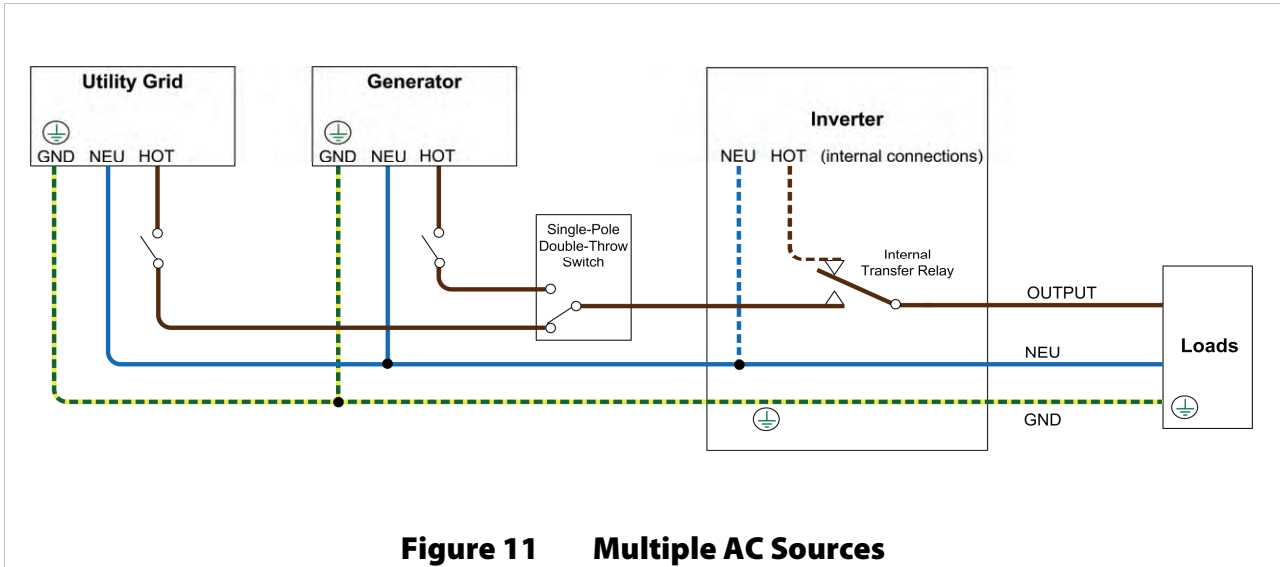

Figure 10 AC Terminals

All system wiring must comply with national and local codes and regulations.

AC Sources

The inverter's transfer relay is normally set to provide inverter power to the output. When an AC source is connected and accepted, the internal transfer relay switches to transfer the AC source power to the loads. (See the *Operator's Manual* for the inverter's acceptance criteria.)



The inverter has a single set of AC terminals which are intended to connect to a single AC source. **It cannot be directly wired to more than one AC source at the same time.** If multiple sources are used, it is usually required to have a selector switch that changes from one to the next. The switch should be the type which disconnects from one source before contacting another. This prevents the risk of connecting to two out-of-phase sources at the same time or connecting them to each other.



IMPORTANT:

When installing a generator, it is recommended to turn off the GFX inverter's Sell feature. See the system display manual for instructions.

Accessory Wiring

The AC Wiring Compartment Board has ports for both the Remote Temperature Sensor (RTS) and the system display. The system display port is labeled MATE/HUB.

If a HUB is in use, it occupies the inverter's MATE/HUB port.

RTS cable (RJ11, 4-conductor, telephone)

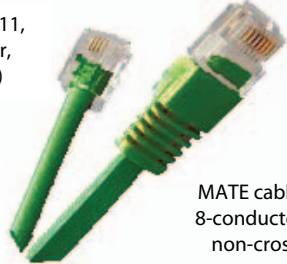

MATE cable (RJ45, 8-conductor, CAT5 non-crossover)

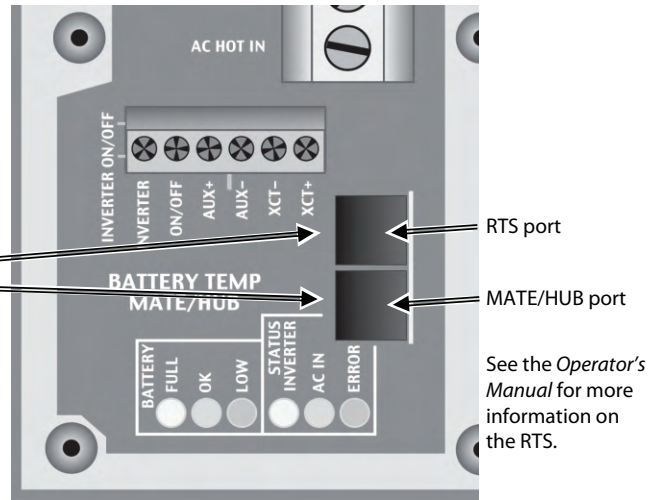

RTS port

MATE/HUB port

See the *Operator's Manual* for more information on the RTS.

Figure 12 Accessory Connections



Additional Ports

MATE port

When a HUB occupies the inverter's MATE/HUB port, the system display connects directly to the HUB. (If the system display is a MATE, do not connect it during initial startup. See the *Operator's Manual* for more information.)

Inverters plug into ports 1 and above. Charge controllers and other devices plug into additional ports after the last inverter is connected. See *Stacking* on page 28 for information on connecting inverters. See the HUB manual for other devices.

The INVERTER ON/OFF jumper bridges two pins. This jumper (JP1) parallels the two INVERTER ON/OFF terminals on the Control Wiring Terminal Block. If either set of connections is closed, the inverter is ON. (Because the jumper is factory-installed, the inverter usually remains ON unless given a command by the system display.)

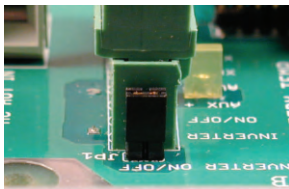

Jumper On

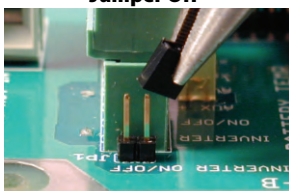

Jumper Off

Removing the jumper will turn the inverter OFF. To remove the jumper, use long-nose pliers or a similar tool.

Once the plastic INVERTER ON/OFF jumper has been removed, the INVERTER ON/OFF terminals on the Control Wiring Terminal Block can be used to wire a manual on/off switch.

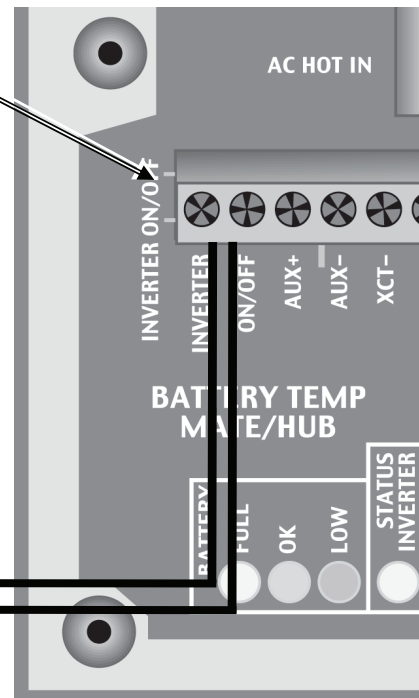

Figure 13 ON/OFF Jumper and Connections

AUX Wiring

The AUX+ and AUX- terminals are a switched 12 Vdc supply. The AUX can respond to many criteria and control many functions. These include cooling fans, vent fans, load diversion, fault alarms, and automatic generator control. The AUX output can also be controlled externally through the system display. (For generator control, see the next page. For all other functions, see the system display manual and the *International Series GFX Operator's Manual*.) The AUX output can only control one function at a time.

The terminals can supply up to 0.7 amps at 12 Vdc (8.4 watts). This is sufficient to drive a small fan, or a relay which can control a larger device. The terminals accept up to 2.5 mm² (#14 AWG) wire.

The AUX circuit contains electronic overcurrent protection, which resets after being overloaded. No additional fuses are required for the AUX terminals.

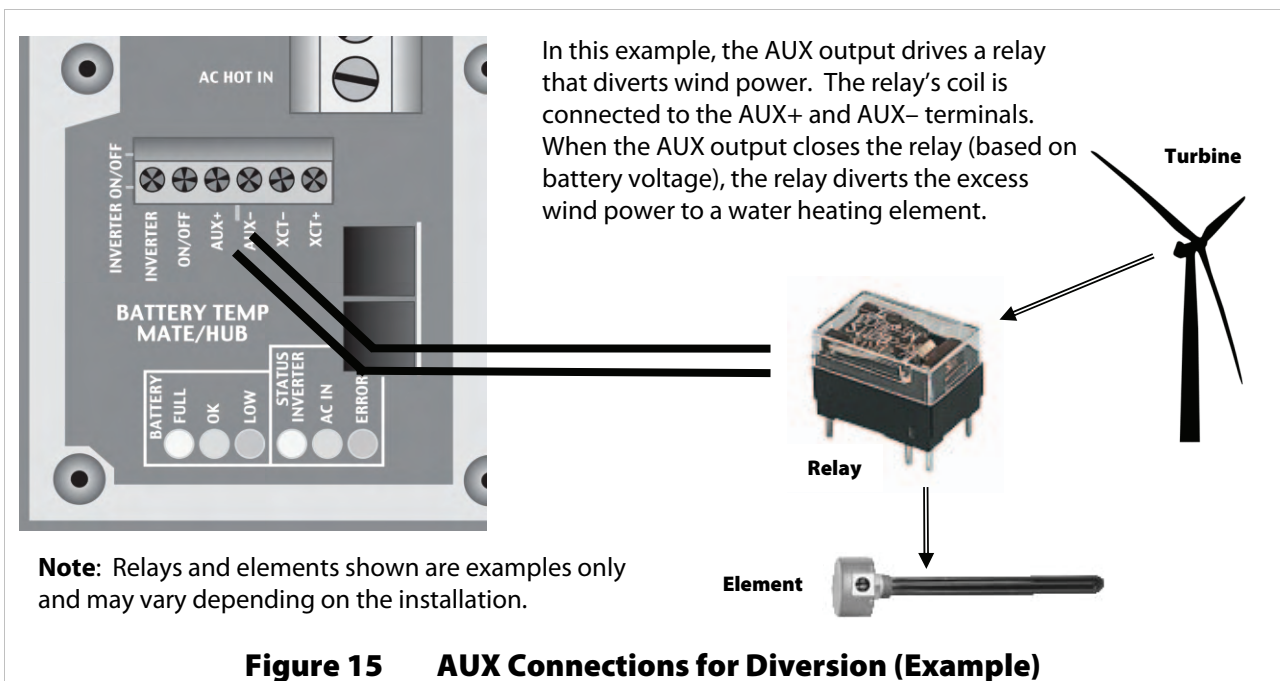
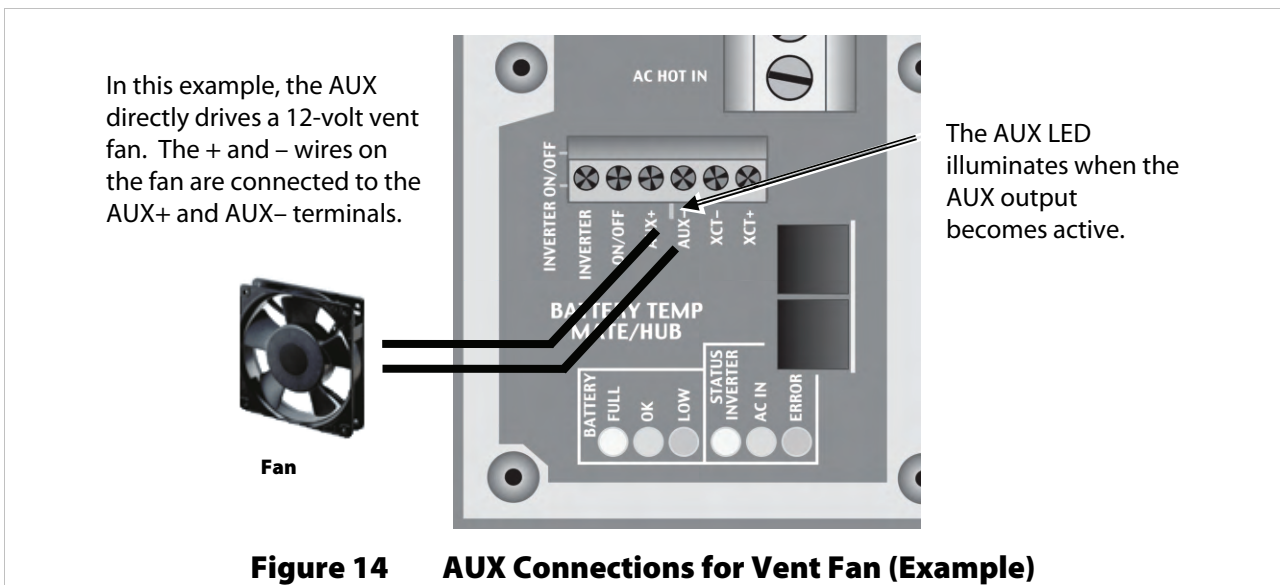

Automatic Generator Start (AGS)

The AUX terminals can be used to perform “two-wire” generator start. A two-wire-start generator is the simplest type, where most of the circuits are automated. It usually has a single switch with two positions that is turned ON to start, OFF to stop.

Either the system display or the FLEXnet DC can be programmed to perform automatic generator start using the AUX terminals. See the system display or FLEXnet manuals for programming instructions.

Two-Wire-Start

The 12 Vdc signal provided by the AUX output can be switched on and off to provide a start signal. It is not usually recommended to connect the AUX terminals directly to the generator, but to use them to energize the coil of a 12 Vdc automotive or similar relay.

Depicted is the OutBack FLEXware Relay Assembly, which is sold for this purpose. The relay contacts can serve in place of the generator’s start switch. The battery shown below is depicted for clarity. In most cases, it is part of the generator’s internal starting circuit and is not an external component.

The drawing below is one example of a possible arrangement. Specific arrangements, relays, and other elements depend on the requirements of the installation and of the generator.

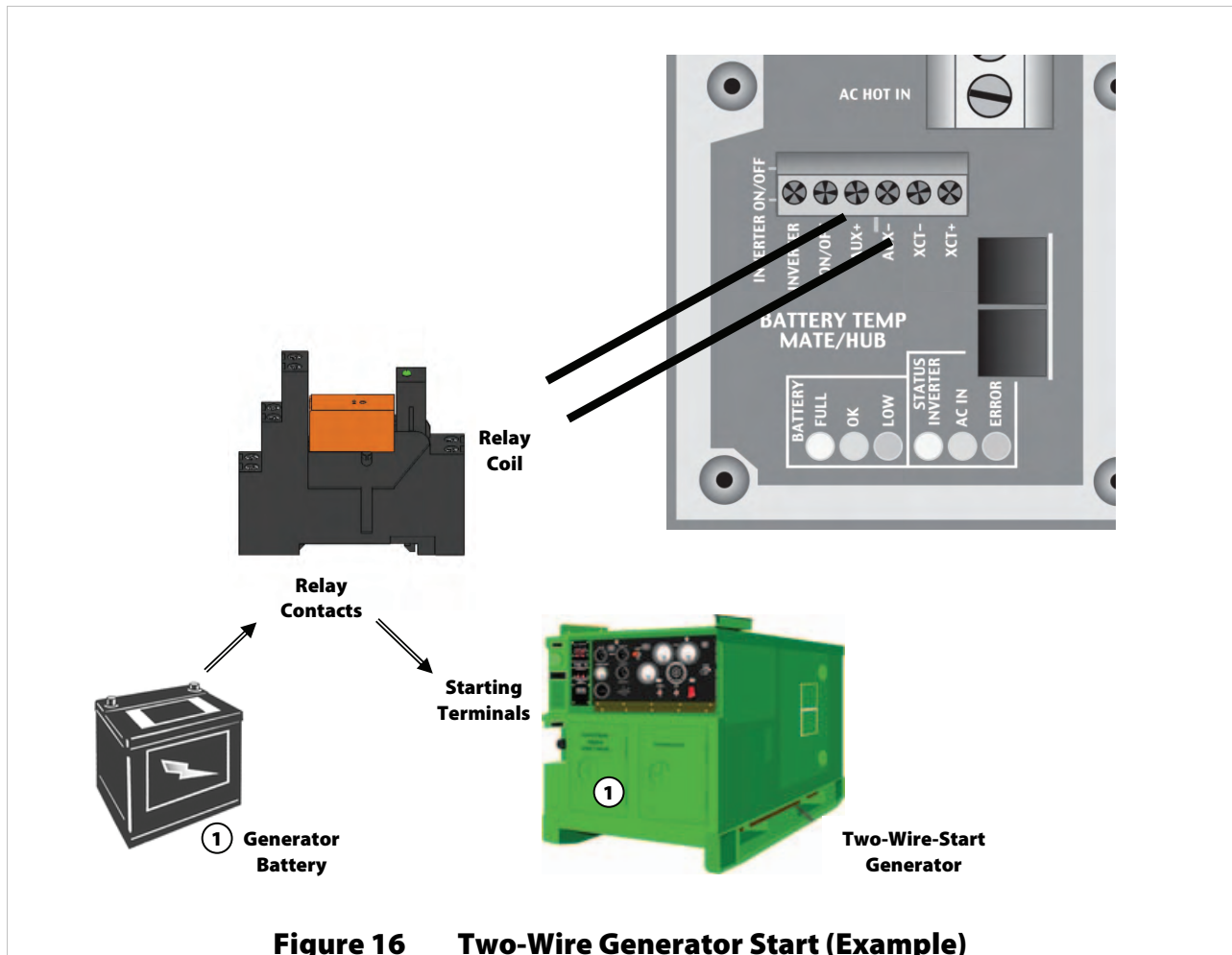

Figure 16 Two-Wire Generator Start (Example)

Installation

Three-Wire-Start

A “three-wire-start” generator has two or more starting circuits. It usually has a separate switch or position for cranking the generator. A three-wire generator has fewer automated functions than a two-wire. It usually requires multiple controls for starting, running, or stopping. The AUX terminals cannot control this type of generator without using a three-wire to two-wire conversion kit.

Atkinson Electronics (<http://atkinsonelectronics.com>) is one company that makes these kits. The Atkinson GSCM-Mini is intended to work with OutBack inverters.

The drawing below is one example of a possible arrangement. Specific arrangements, relays, and other elements depend on the requirements of the installation and of the generator.

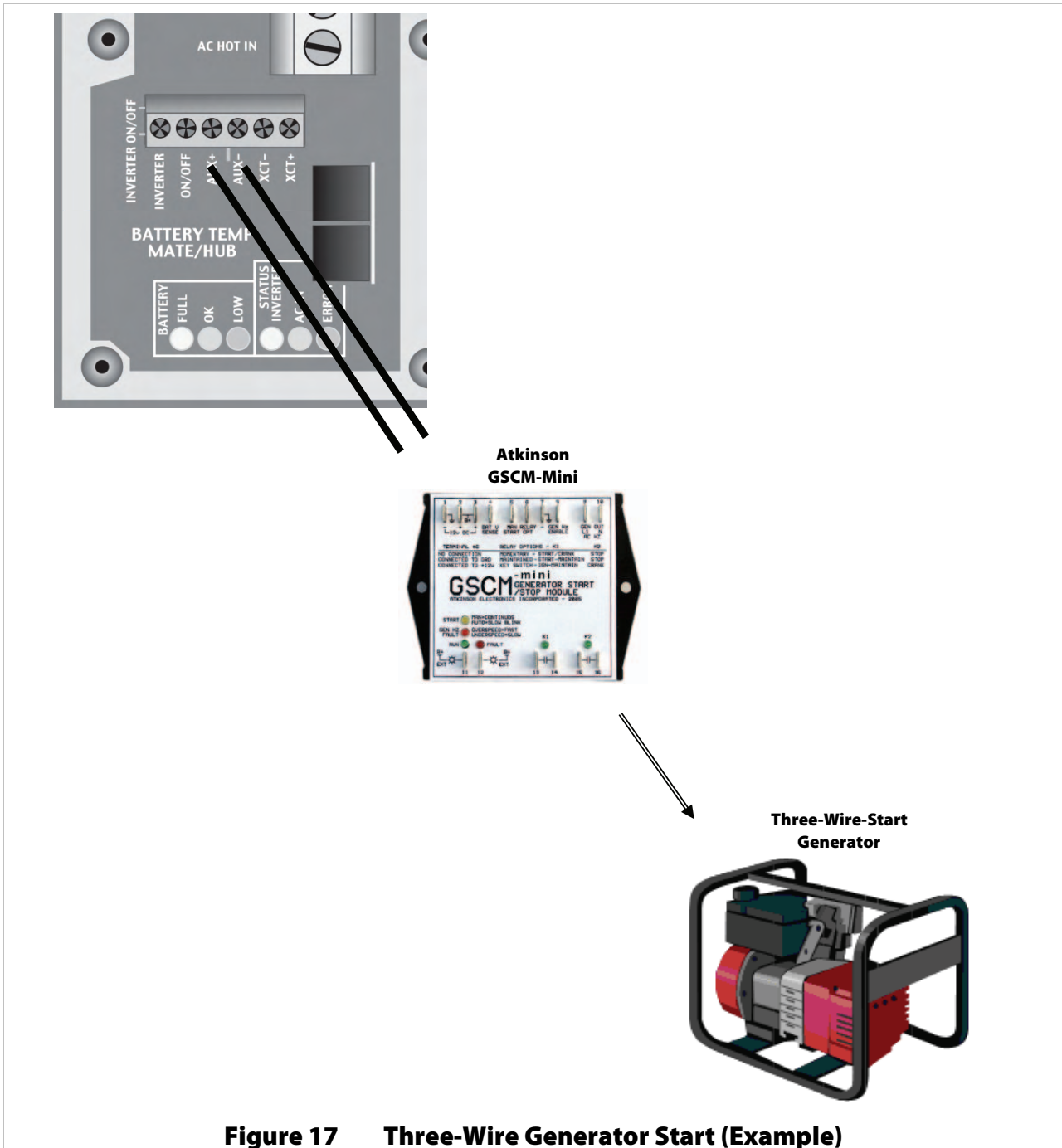

Single-Inverter AC Installations

When installing an inverter AC system, the following rules must be observed.

- All overcurrent devices must be sized for 30 Aac or less.
- All wiring must be sized for 30 Aac or more.
- All output circuit breakers must be sized appropriately for loads and inverter wattage.

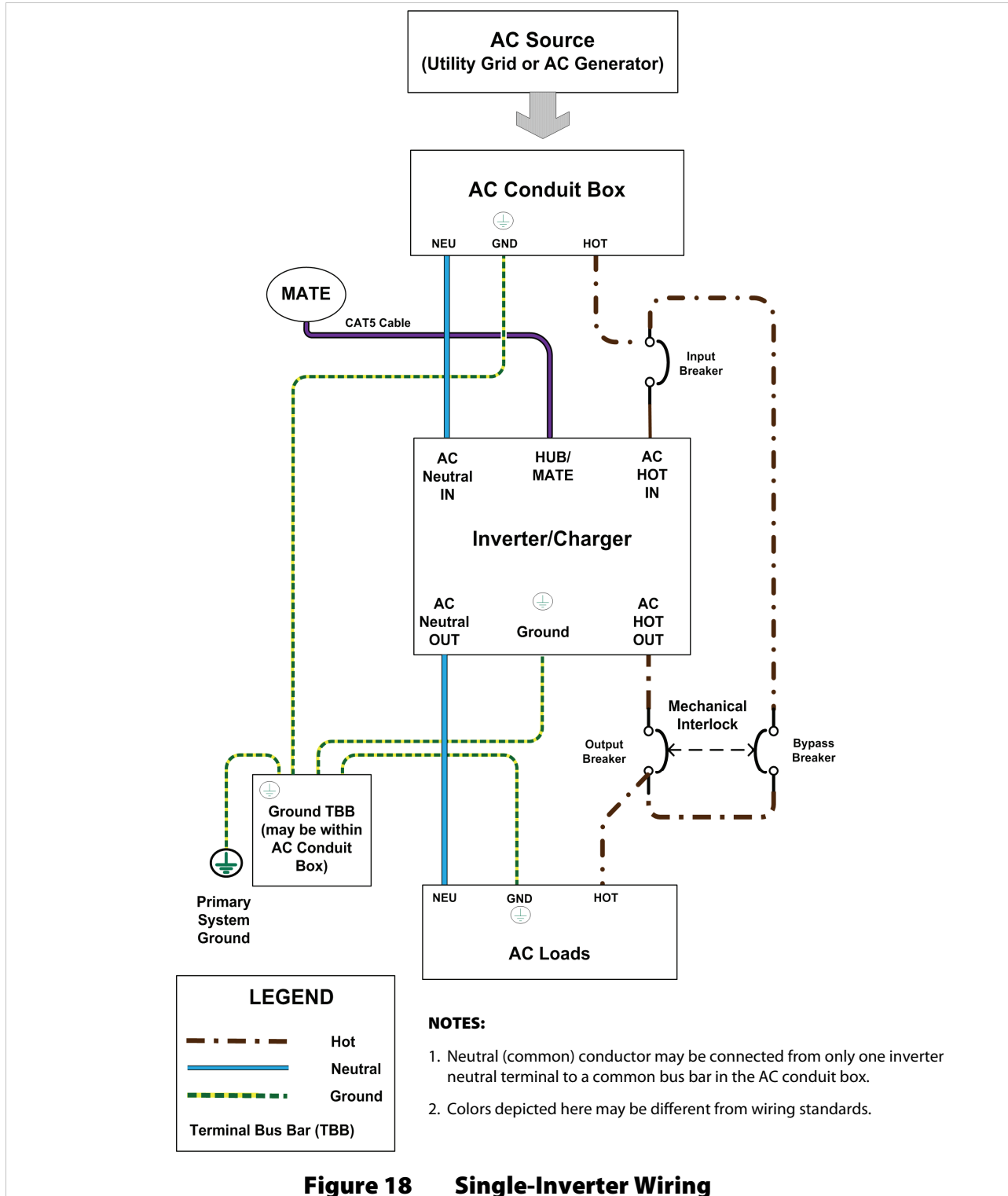

Figure 18 Single-Inverter Wiring

Multiple-Inverter AC Installations (Stacking)

Installing multiple inverters in a single AC system allows larger loads than a single inverter can handle. This requires stacking. Stacking inverters does not refer to physically placing one on top of another. It refers to how they are wired within the system and then programmed to coordinate activity. Stacking allows all units to work together as a single system.

Examples of stacking configurations include “parallel” and “three-phase” configurations.

Stacking Connections

Stacking requires an OutBack HUB product, as well as a system display, such as the OutBack MATE or MATE3. (If the MATE is used, it must have firmware revision 4.1.6 or above.) A system using four or fewer units may use the HUB4. Systems using up to ten units require the HUB10. All interconnections are made using CAT5 noncrossover cable.

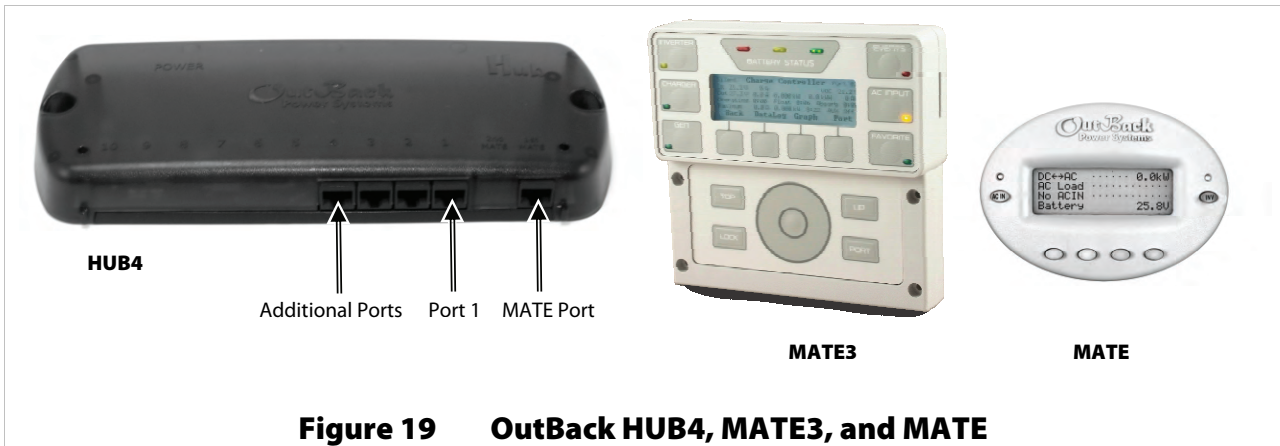

Each inverter must be assigned a status — “master” or “slave”. The master is the primary and most heavily used unit. The master inverter’s MATE/HUB port must connect to port 1 on the HUB.

Slave inverters provide assistance when the loads are more than the master can handle alone. Slaves plug into ports 2 and above on the HUB. In general, it does not matter which slave connects to which port. However, it is always important to keep track of units and ports for programming purposes. See the system display manual for more information.

Programming involves using the system display to assign a status and stacking value to the inverter on each port. Each inverter is assigned to power a specified phase of the system. These assignments can be changed at any time as long as the master is plugged into port 1.



IMPORTANT:

- The master inverter must always be connected to port 1 on the HUB. Connecting it elsewhere, or connecting a slave to port 1, will result in backfeed or output voltage errors which will shut the system down immediately.
- Installing multiple inverters without stacking them (or stacking them incorrectly) will result in similar errors and shutdown.
- Although stacking allows greater capacity, the loads, wiring, and overcurrent devices must still be sized appropriately. Overloading may cause circuit breakers to open or the inverters to shut down.

Parallel Stacking (Dual-Stack and Larger)

In parallel stacking, two or more inverters are stacked to create a single, common 230 Vac bus.

- All inverters share a common input (AC source) and run loads on a common output.
- Up to ten inverters may be installed in a parallel arrangement. The example on this page shows three inverters. The wiring diagram on the next page shows four.

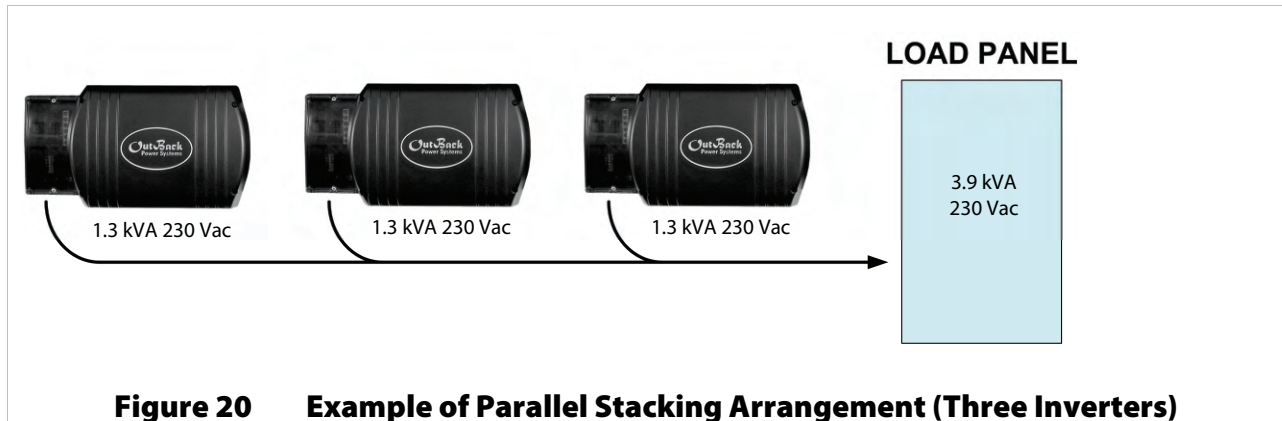

When installing a parallel system, the following rules must be observed.

- Parallel stacking requires a system display and a HUB.
- The inverter that is mounted physically lowest is always the master and is programmed as **Master**. (See the system display manual for programming.) Mounting below the other inverters allows the master to avoid heat buildup and remain relatively cool as it sees the greatest duty cycle.
- The master must be connected to port 1 of the HUB. Other inverters must not be selected as master.
- All slave inverters, regardless of quantity, should be selected as **OB Slave L1** during programming.
- All overcurrent devices must be sized for 30 Aac or less.
- All wiring must be sized for 30 Aac or more.
- All output circuit breakers must be sized appropriately for loads and inverter wattage.
- All inverters must be of the same model.
- The AC input (generator or utility grid) must be 230 Vac at 50 Hz (single-phase).
- When wiring the AC source to the inverters, local codes may require the inverter circuits to be located at the opposite end of the panel from the main circuit breaker. This prevents overloading of the AC bus.

Three-Phase Stacking

In three-phase stacking, inverters are stacked to create three separate 230 Vac output legs in a wye configuration.

- The output of each inverter is 120° out of phase from the others. Any two outputs produce 400 Vac between them. The outputs can be used to power three-phase loads when all inverters work together.
- Only three inverters, one per phase, may be installed in a three-phase arrangement.

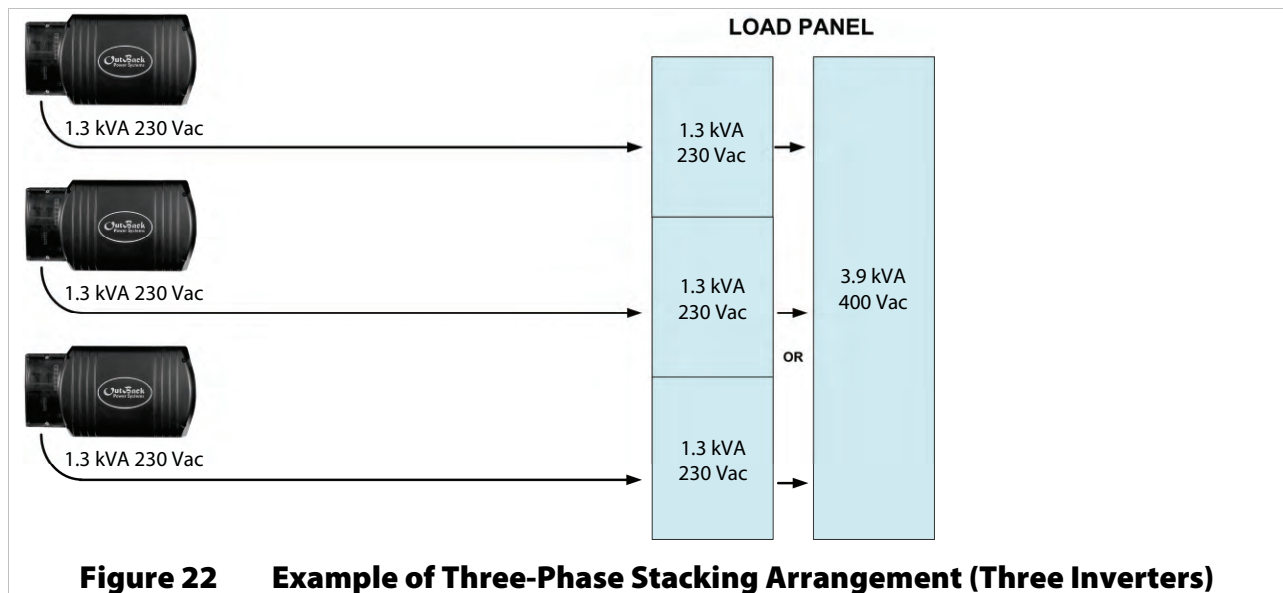

When installing a three-phase system, the following rules must be observed.

- Three-phase stacking requires a system display and a HUB.
- The inverter that is mounted physically lowest is always the master and is programmed as **Master**. (See the system display manual for programming.) Mounting below the other inverters allows the master to avoid heat buildup and remain relatively cool as it sees the greatest duty cycle.
- The master must be connected to port 1 of the HUB. Other inverters must not be selected as master.
- One slave inverter must be programmed as **3p Classic B**. The other must be programmed as **3p Classic C**. (See the system display manual for programming.)
- The inverters should be wired to the loads and to the AC sources in phase order. The master should be phase A, the first slave should be phase B, and the second slave should be phase C.
- All overcurrent devices must be sized for 30 Aac or less.
- All wiring must be sized for 30 Aac or more.
- All output circuit breakers must be sized appropriately for loads and inverter wattage.
- All inverters must be of the same model.
- The AC input (generator or utility grid) must be 230/400 Vac at 50 Hz (a three-phase wye configuration).
- When wiring the AC source to the inverters, local codes may require the inverter circuits to be located at the opposite end of the panel from the main circuit breaker. This prevents overloading of the AC bus.



IMPORTANT:

Although the HUB manual states that it is necessary to move the HUB's jumper to the three-phase position, that statement is not applicable for this model. The jumper must be left in its original position.

Installation

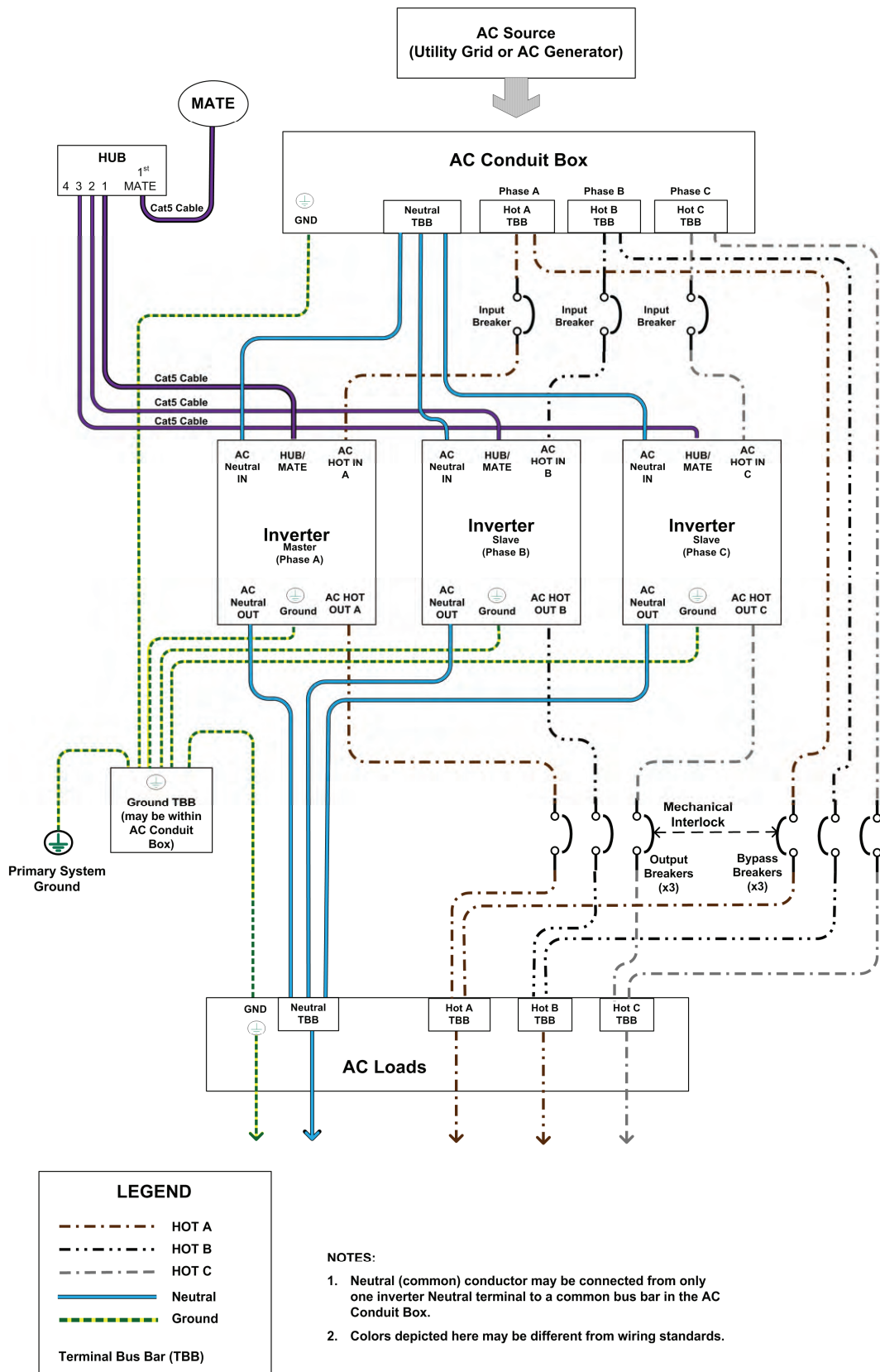

Figure 23 Three-Phase Wiring (Three Inverters)

Functional Test

Once the mounting, wiring, and other installation steps are completed, proceed to the *International Series GFX Operator's Manual*. The Operator's Manual has steps for powering up and performing a functional test on the inverter system, as well as powering down and adding new devices to an existing system.

Refer to the system display manual for programming instructions and menus.



Index

A

AC Conduit Plate.....	12
AC Terminals	19
AC Wiring	23
AGS.....	2
Applications	13
Audience	1
Automatic Generator Start.....	2, 26
AUX.....	2
AUX Terminals	19

B

Battery Bank	4, 14
Battery Terminal Covers	12, 21

C

Communication Cables	24, 30
Components	12
Conductor Size	
AC Conductors.....	23
DC Conductors	21
Ground Conductors	20
Control Wiring Terminal Block	19

D

DC Cover (DCC)	12, 17
DC Terminals.....	19, 22
DC Wiring	21
Definitions.....	2
Dimensions.....	17
Diversion Control.....	25
Drawings	
General System Layout	13
Parallel-Stacked System.....	33
Single-Inverter System.....	29
Three-Phase System.....	36
DVM.....	2, 18

E

Environmental Requirements	17
----------------------------------	----

F

Features	11
Functional Test.....	37

G

Generator	13, 14, 23, 26, 29, 31, 34
Sizing.....	15
GFDI.....	2, 20
Grid-Interactive	2, 13
Grounding.....	19, 20

H

HUB	24, 30
-----------	--------

J

Jumper JP1	19, 24
------------------	--------

L

LED Indicators.....	2, 19
Location.....	17

M

MATE.....	19, 24, 30
Models.....	11
Mounting.....	18
Multiple AC Sources.....	23

O

On/Off Switch, Installing	24
---------------------------------	----

P

Parallel Stacking.....	31
Ports, RJ45 and RJ11	19, 24

R

Recycling Information 6
 Regulatory 6
 Remote System Display2, 14
 Remote Temperature Sensor (RTS)2, 12, 19, 24
 Renewable Energy 14

S

Safety..... 1
 Battery..... 4
 General..... 2
 Inverter..... 3
 Personal..... 3
 Stacking.....30
 Parallel.....31
 Three-Phase.....34
 Symbols Used..... 1
 System Display.2, 14, 19, 23, 24, 25, 26, 30, 31, 34, 37

T

Temperatures 17
 Terms and Definitions 2
 Test.....37
 Three-Phase Stacking34

Tools Required 18
 Torque Requirements
 AC Terminals23
 DC Terminals.....21
 Ground Terminals.....20

U

Utility Grid.....2, 13, 23, 29, 31, 34

V

Vent Fan 25

W

Wiring
 AC Connections 23
 AUX Connections 25
 DC Connections 21
 Ground Connections 20
 Parallel (Four Inverters) 33
 Three-Phase (Three Inverters) 36

X

XCT 19



North America:
5917 – 195th St NE, #7
Arlington, WA 98223 USA
+1.360.435.6030