



Installation Manual

for SunEdison Silvantis 60 cell Photovoltaic Modules

Product List: M245CyC, M250CyC, M255CyC, M260CyC, M265CyC, M270CyC, M245KyC, M250KyC, M255KyC, M260KyC, M265KyC, M270KyC, F245CyC, F250CyC, F255CyC, F260CyC, F265CyC, F270CyC, F245KyC, F250KyC, F255KyC, F260KyC, F265KyC, F270KyC



Table of Contents

1.0 INTRODUCTION	2
2.0 PHOTOVOLTAIC MODULES PRODUCT CODE	2
3.0 MODULE OVERVIEW	2
3.1 STORAGE, UNPACKING, AND HANDLING	2
3.2 SAFETY	3
3.3 MAINTENANCE.....	3
4.0 MECHANICAL INSTALLATION	4
4.1 PLANNING AND DESIGN	4
4.2 MODULE MOUNTING OPTIONS.....	4
4.3 ADDITIONAL MOUNTING METHODS	7
4.4 MECHANICAL INSTALLATION WARNINGS	7
5.0 ELECTRICAL INSTALLATION	7
5.1 PLANNING AND DESIGN	7
5.2 MODULE WIRING	8
5.3 GROUNDING	8
5.4 ELECTRICAL INSTALLATION WARNINGS	10
6.0 DISCLAIMER OF LIABILITY	10
7.0 APPENDIX	11
7.1 MODULE ILLUSTRATIONS	11
7.2 PHYSICAL PARAMETERS	11
7.3 PRE-MOUNTED CABLES AND CONNECTORS	12

Customer Service

SunEdison Products Singapore PTE. LTD.
 11 Lorong 3 Toa Payoh
 Block B Jackson Square 4th Floor
 Singapore 319579

Fax: (65) 6681-9301
 Email: modules.info@sunedison.com
 Website: www.sunedison.com

1.0 INTRODUCTION

The purpose of this guide is to provide general information regarding the proper installation and handling of SunEdison photovoltaic modules that serve residential, commercial, and industrial segments. System design, construction, and commissioning should be performed by qualified personnel only.

To ensure system integrity, designers, installers and operators must meet all mechanical and electrical requirements for the system and its components. It is the responsibility of the system designer and installer to ensure that all codes and requirements are followed as well.

Please review all the sections that pertain to proper installation of modules listed in this guide. The instructions detailed in this guide must be followed throughout the module's lifetime deployment. If you need additional information about the safe, proper use and handling of SunEdison photovoltaic module products, please contact SunEdison.

2.0 PHOTOVOLTAIC MODULES PRODUCT CODE

This guide is to be used for SunEdison Silvantis 60 cell photovoltaic (PV) module installation. Please refer to the following module numbers before using the guide:

Original Version: M245CyC, M250CyC, M255CyC, M260CyC, M265CyC, M270CyC, M245KyC, M250KyC, M255KyC, M260KyC, M265KyC, M270KyC, F245CyC, F250CyC, F255CyC, F260CyC, F265CyC, F270CyC, F245KyC, F250KyC, F255KyC, F260KyC, F265KyC, F270KyC

3.0 MODULE OVERVIEW

SunEdison Silvantis Photovoltaic modules consist of a series of electrically interconnected crystalline silicon solar cells that are sealed within a laminated sheet of tempered glass superstrate* and EVA/back-sheet substrate. These laminates are secured inside an aluminum frame to provide rigidity and a means for attachment to mounting sub-structures. The frames should not be modified or removed. * *Tempered glass may have anti-reflective coating.*

- Photovoltaic modules are designed and constructed for outdoor use. Do not submerge modules in water at any time.
- The front and back of each module is labeled with a product bar code. Do not cover, remove or deface these labels. This may be required for product identification.
- Damage to the glass surface or the anti-reflective coating can impact the power output and overall efficiency of the system. Scratches, handling marks, or any damage to the glass surface must be avoided.
- For best performance and to avoid potential issues, keep the front side of the module clean and free of obstructions including covers, tape, adhesives, paint and debris.

3.1 STORAGE, UNPACKING, AND HANDLING

- Packaged modules must be stored in a dry and ventilated area.
- Packaged modules must not be exposed to rain, snow, hail or other environmental conditions that may compromise the packaging material and the modules.
- Packaged modules must be on appropriate provided pallets and must not be stacked more than two pallets high for storage.
- Once the modules are opened, store modules in a dry and ventilated room.
- Modules should never be stored in a wet environment.
- Upon unpacking, do not carry a module by its wires or junction box. Only carry a module by its frame with two or more people.
- Precaution should be taken to avoid damage to the glass surface with or without anti-reflective coating due to improper handling during storage or unpacking. Do not place or store modules with the glass facing down.
- Keep all electrical contacts clean and dry.
- All modules are manufactured with a sealed junction box and pre-attached cables and locking connectors. These components should not be modified or tampered with in any way.

- Do not allow unauthorized persons near the installation site or storage area of modules.
- Do not place any load on the module or twist the module frame.
- Do not stand, step, walk, or jump on the module.
- Do not drop or place objects on the modules such as tools.
- Do not handle modules with bare hands and avoid scratches, handling marks, or any damage especially to the front glass of the module, backsheet, or electrical components.
- Do not mark the modules with sharp instruments.
- Do not leave a module unsupported or unsecured.
- Do not modify module frames in any way.

3.2 SAFETY

The following safety guidelines and best practices should be followed:

- All installations must be performed in compliance with all applicable regional and local electrical codes or other national or international electrical standards.
- Use insulated tools during installation, troubleshooting and maintenance of photovoltaic modules.
- Wear suitable protection to prevent direct contact with module's electrical output and mechanical sharp edges.
- Cover the front of the modules with an opaque material to stop production of electricity when installing or working with a module or wiring.
- Modules connected in a series should not be disconnected under illumination. Disconnecting modules under illumination may cause electrical arcing which may result in burns, fires or other problems.
- Follow industry best practices when commissioning, trouble shooting, disconnecting, or connecting a PV system.
- Trouble shooting should include planning, checking, disconnecting, cause seeking, replacement, and record keeping.
- Do not install or handle the modules or their components when they are wet or during periods of high wind.
- Do not attempt to disassemble, repair, or open any part of the module including junction box or sub-components.
- Do not artificially concentrate sunlight on a module.
- Do not install or handle any broken modules. If a module is broken, or the back sheet is torn, contact with the surface or frame can cause an electrical shock.
- Do not wear rings, jewelry, watches, or other metallic items while working with photovoltaic modules.

3.3 MAINTENANCE

Check modules, glass, and frames for damage. Regularly inspect all SunEdison Silvantis Solar Modules for safe electrical connections, sound mechanical connections, and freedom from shading and corrosion. If dirt or debris buildup becomes excessive, periodically clean the glass only with a soft cloth using mild, non-abrasive detergent and water. When using mild cleaning liquids, a neutral pH in the range of 6.0 to 8.0 is recommended. Chemicals with pH less than 6.0 or greater than 8.0 should be avoided as it may damage the glass surface and/or the AR coating. Please consult with system designer to decide the cleaning and inspection frequency according to local environmental conditions.

Do not power wash or use harsh cleaning materials or objects such as scouring powder, steel wool, scrapers, blades, or other sharp instruments to clean the glass surface of the module. Use of such materials will invalidate the product warranty.

WARNING: Use caution when cleaning the back surface of the module to avoid scratching the substrate materials.

4.0 MECHANICAL INSTALLATION

4.1 PLANNING AND DESIGN

- Before installation, check to ensure the sub-structure will accommodate expected system loads. This includes and is not limited to roof, foundations, mechanical structure, and mechanical connections.
- For roof installations, utilize a fire-resistant roof covering rated for the application. A minimum clearance of 6 inches is required between the roof and bottom of the module frame.
- Mechanical structures should not contact the module backsheet, any racking, or microinverter under any expected load conditions
- Consider the following factors during system design, which will influence performance:
 - a) SunEdison solar modules produce the most power when they are pointed directly at the sun, and should be tilted for optimum system performance.
 - b) Proximity to obstructions such as: walls, buildings, trees, groundcover, snow cover, or dust and debris that have the potential to shade or damage the modules.
 - c) Elevated temperatures will decrease energy yield, so designs should ensure adequate airflow across the back of the module.
 - d) Allow a minimum spacing of 10 mm between modules for thermal expansion.

4.2 MODULE MOUNTING OPTIONS

For clamp or bolt mounting locations, please refer to table 4.2A

- Each module should be mounted using four bolts through the mounting holes on the rear side of the module, or with four clamps over the front side. No more than two clamps per side may be used.
- Depending on the desired load capability of the array, modules may be mounted either perpendicular or parallel to the structure rails. Clamps can be mounted anywhere inside of the safe mounting range for each case illustrated in table 4.2A.
- If using bolts, use a bolt stack no smaller than ¼"-20 or M6, with two flat washers and a locking washer as shown in Appendix 7.1.
- To ensure an adequate clamping area, all clamps must be able to clamp within the range specified in Table 4.2A. All fasteners used to fix the modules with clamps should be no smaller than ¼"-20 or M6.
- To provide adequate fixing or clamping force, torque the fasteners to the manufacturers torque specifications.
- For all cases, the area of the supporting structure in contact with rear side of the module must comply with the dimensions specified in Appendix 7.1.
- All other structural dimensions, such as clamp and rail thickness, should be sized appropriately for the intended site load.

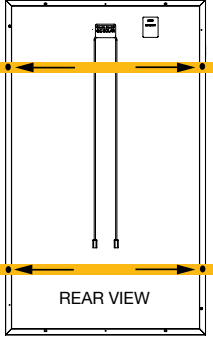
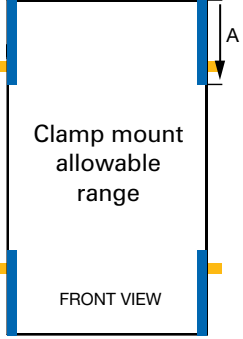
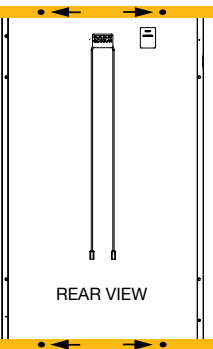
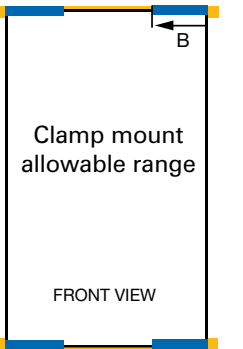
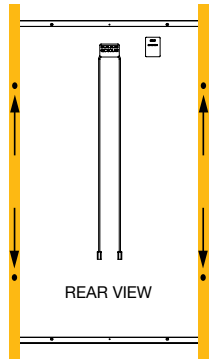
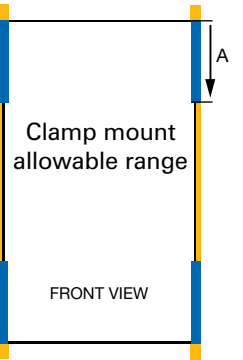

TABLE 4.2A

MOUNTING CONFIGURATIONS	LOAD PARAMETERS	BOLT MOUNT LOCATIONS	CLAMP MOUNT LOCATIONS
<p>PERPENDICULAR MOUNTING (CASES 1 & 2)</p> <p>Structural rails running perpendicular to the length of the module should be fixed via bolts or clamps at the mounting holes between each long side frame, OR at the holes on each short end frame.</p>	<p>CASE 1</p> <p>Maximum Rear Load: 2400 Pa or 50 psf</p> <p>Maximum Front Load: 5400 Pa or 113 psf</p>	 <p>REAR VIEW</p>	 <p>FRONT VIEW</p>
	<p>CASE 2</p> <p>Maximum Rear Load: 2400 Pa or 50 psf</p> <p>Maximum Front Load: 5400 Pa or 113 psf</p>	 <p>REAR VIEW</p>	 <p>FRONT VIEW</p>
<p>PARALLEL MOUNTING (CASE 3)</p> <p>Structural rails running parallel to the length of the module should be fixed ONLY via bolts at the mounting holes or clamps within the allowable clamp range on each long side frame.</p>	<p>CASE 3</p> <p>Maximum Rear Load: 2400 Pa or 50 psf</p> <p>Maximum Front Load: 5400 Pa or 113 psf</p>	 <p>REAR VIEW</p>	 <p>FRONT VIEW</p>

Module Color Code: ● Mounting Hole Location ■ Module Rail ■ Clamp Mount Range

Clamp mount allowable range: A:0 – 382 mm
B:0 – 248 mm

TABLE 4.2A

MOUNTING CONFIGURATIONS	LOAD PARAMETERS	CLAMP MOUNT LOCATIONS
<p>FULL LENGTH CLAMPING (CASES 4&5) When clamping the module full width across the ends it is unsupported along the unclamped edge.</p>	<p>CASE 4</p> <p>Maximum Rear Load: 2400 Pa or 50 psf</p> <p>Maximum Front Load: 5400 Pa or 113 psf</p>	 <p>Clamp mount allowable range</p> <p>FRONT VIEW</p>
	<p>CASE 5</p> <p>Maximum Rear Load: 2400 Pa or 50 psf</p> <p>Maximum Front Load: 5400 Pa or 113 psf</p>	 <p>Clamp mount allowable range</p> <p>FRONT VIEW</p>

Module Color Code:  Clamp Mount Range

4.3 ADDITIONAL MOUNTING METHODS

4.3 Use of the PanelClaw system (Part Number 500000501) is permitted with SunEdison Solar PV Modules. Structures manufactured by PanelClaw Inc. use a special clamp, or "claw" designed to attached to the flange of the PV module at all four corners, on the two short frame ends. For proper placement, attach a claw over the module frame flange at each of the four designated locations and tighten the screw so that the claws are flush with the long and short ends of the module flange. This mounting method has been tested to a maximum rating of 50 psf in the negative and positive direction. See case two in Table 4.2A above as well as the PanelClaw installation guide for information on the installation of the clamps.

Figure 1: Illustrations of the Panel Claw

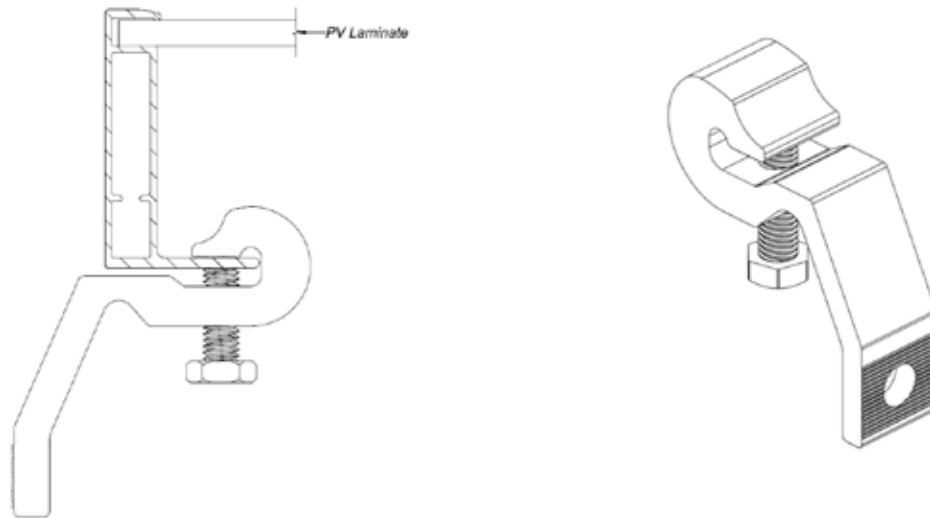

4.4 MECHANICAL INSTALLATION WARNINGS

- Installation and maintenance should be performed by qualified personnel only.
- Use insulated tools during installation, troubleshooting and maintenance of photovoltaic modules.
- Installers should adhere to all applicable local, regional, and national codes and regulations when designing and constructing the photovoltaic system.
- Do not stand or walk on any surface of the modules.
- Precaution should be taken to avoid damage to the glass surface with or without anti-reflective coating due to improper handling during installation.
- Mechanical structures should not contact the module backsheet under any expected load conditions.
- Additional mounting holes may not be drilled in the frame, glass or backsheet.
- Ensure that frame weep holes are not obstructed by the mechanical installation.

5.0 ELECTRICAL INSTALLATION

5.1 PLANNING AND DESIGN

- All modules are manufactured with a sealed junction box and pre-attached cables and locking connectors. These components should not be modified or tampered with in any way.

NOTE: Installers shall ensure that the polarized locking connectors are from the same supplier when connected on the same string. Do not mix polarized interlocking connectors from different manufacturers—including connections at the inverter, combiner boxes, and modules. Doing so will void the warranty. Refer to section 7.2 for connector types.

- Ensure connectors are clean and dry before establishing connection.
- Ensure that all wire, fusing and disconnects are appropriately sized for the system design according to national, regional, and local codes.
- Electrical characteristics are within plus or minus 5% of rated values for I_{sc} , V_{oc} , I_{mpp} and V_{mpp} . Modules may operate under conditions which may be significantly different than STC. SunEdison suggests multiplying specified ratings by a minimum of 1.25 times or more when specifying the system and balance of system components. Installer should adhere to all local, regional and national codes before planning and design of the system. *Refer to local codes before planning and design of the system. For detailed electrical characteristics, please refer to Section 7.0, page 10 through 11 of this Installation Manual.*
- Determine the maximum number of modules connected in series using the following formula: $N_s = V_{max_s} / V_{oc_m}$

Where:

N_s equals the maximum modules in series

V_{max_s} equals the maximum system voltage and is limited to a maximum of 1000 V for IEC and 600 V for UL

V_{oc_m} equals the module open circuit voltage at coldest conditions for the site (refer to local codes)

WARNING: Installers should adhere to all applicable local, regional, and national codes and regulations when designing and constructing the photovoltaic system.

NOTE: In colder climates, it may be necessary to further reduce the maximum number of modules in series by using V_{oc_m} at the minimum expected operating temperature.

5.2 MODULE WIRING

- The module includes wires and polarized locking connectors from the junction box on the back of the module. The wires have sufficient length to connect to adjacent modules in either a portrait or landscape configuration assuming the minimum spacing between module frames. Field replacement of connectors or cables must be avoided and it will invalidate the product warranty. Polarized locking connectors of the same type and make are required for all series string wiring. The maximum operating temperature of wires and connectors should not exceed 85°C.
- When installing panels in landscape orientation, use of the 1.3 meter lead lengths will ensure enough cable length to make adjacent, module-to-module, string connections, assuming a maximum spacing of 50mm between adjacent modules.
- When installation panels in portrait orientation, use of the .55 or 1.0 meter lead lengths will ensure enough cable length to make adjacent, module-to-module, string connections, assuming a maximum spacing of 50mm between adjacent modules.

- Always wire modules so that proper polarity is maintained. Avoid placing excessive tension on the cables.
- There is no limit to the maximum number of series strings that can be combined in parallel. However, when doing so, each string must include overcurrent protection with a maximum rating of 15A. SunEdison recommends the use of DC rated fuses or overcurrent protection devices with the appropriate maximum voltage rating.
- Do not connect modules of three or more strings directly to a parallel bus.
- The cross-sectional area of cable and the connector type must be selected to align with the overall system design and should include the maximum short circuit current of the system, maximum operating temperatures, and cable run lengths.
- For field connections, use at a minimum #12 AWG/4 mm² wires insulated for a minimum of 85°C. Use copper wire only.

5.3 GROUNDING

WARNING: Only negative grounding circuits (negative polarity to ground) shall be used within the array design. Transformerless inverters with floating grounding are not acceptable.

- All module frames and mounting racks must be properly grounded in accordance with all local and national electrical codes, using methods and devices that are UL 1703/2703 certified.
- Lug Method: A copper, stainless steel, or tin plated grounding lug that is rated for outdoor use and uses no smaller than a #12 wire is acceptable. The use of a copper split bolt connector is authorized for use as well.
- Alternative Methods: Other code compliant frame grounding methods that are certified to UL 1703/2703 are acceptable.
- The frame has predrilled holes marked with a grounding sign as illustrated below. These holes should be used exclusively for grounding purposes and may not be used for any other purpose. **Do not drill additional or modify existing holes in the frame.**

Figure 1: Image of the grounding holes

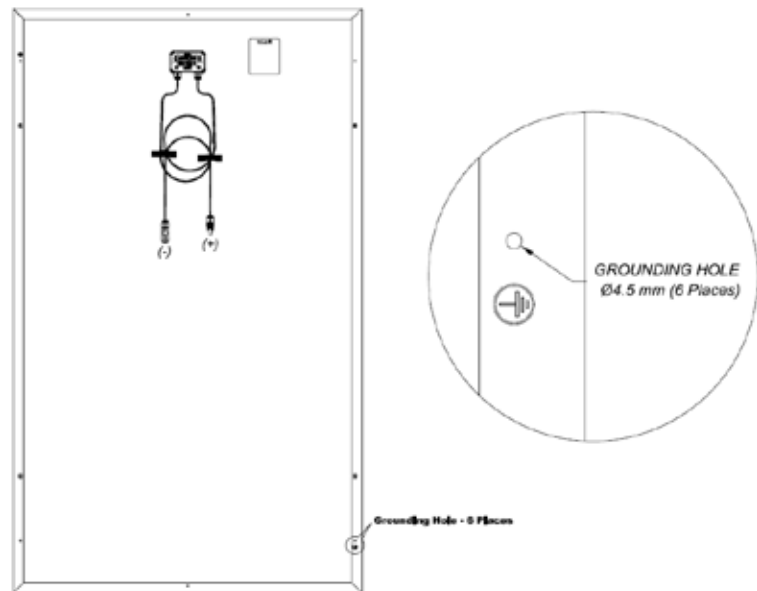

5.4 ELECTRICAL INSTALLATION WARNINGS

- Installation and maintenance should be performed by qualified personnel only.
- Use insulated tools during installation, troubleshooting and maintenance of photovoltaic modules.
- Installers should adhere to all applicable local, regional, and national codes and regulations when designing and constructing the photovoltaic system.
- Photovoltaic modules produce DC electrical energy from light. When illuminated, each module can have a DC potential of greater than 45V and should be handled with care.
- Disconnecting modules under illumination may cause electrical arcing which may result in burns, fires, or other problems. Modules connected in series should not be disconnected under illumination.
- Always use a wire management system that keeps wires and cables out of direct contact with edge surfaces which could cut or damage the insulation. Do not allow wires to rest on the ground or roof surface.
- The module junction box should not be opened or modified in any way in the field.
- Do not use mirrors, lenses, or other techniques to magnify or concentrate additional light on the module.

6.0 DISCLAIMER OF LIABILITY

The information in this manual is based on SunEdison’s knowledge and experience and is believed to be accurate. However, all information in this manual (without exception) including recommendations and specifications does not constitute a warranty, expressed or implied. SunEdison reserves the right to change the manual, the module, or specifications without prior notice.

The product warranty shall be VOID if handling and installation of the product does not conform to SunEdison’s written installation instructions, or if the product has been reworked, repaired or otherwise modified in a manner not previously authorized by SunEdison in writing, or if the product is installed in an environment for which it was not designed. SunEdison shall not be liable for special, indirect, consequential, contingent or incidental damages related to or arising from the installation or use of the product by purchaser under any circumstances.

SunEdison Modules are certified by:



SunEdison assumes no responsibility for any product application or use which is beyond SunEdison’s direct control. SunEdison does not accept responsibility and expressly disclaims liability for loss, damage, or expense arising out of or in any way connected to such installation, operation or maintenance of the product.

International Product Certifications:
IEC 61215, IEC61730, CE, UL 1730, and Safety Class II certifications ensure that SunEdison solar products operate safely and comply with global electrical, performance, reliability, and fire safety codes.

Certification	<ul style="list-style-type: none"> • IEC61215 certified by TÜV SÜD • IEC61730 certified by TÜV SÜD to ensure electrical safety • Stringent outgoing quality acceptance criteria benchmarked to industry standards • UL1703 listed by CSA for Canada and US
Environmental	AB8 (-50°C to +40°C)
Fire Resistance Rating	Class C

7.0 APPENDIX

7.1 MODULE ILLUSTRATIONS

M265 SOLAR MODULE DIMENSIONS mm[in]

MODULE DIMENSIONS

- A - 990 [39.0]
- B - 1,658 [65.3]
- C - 50 [2.0]
- D - 30 [1.18]

MOUNTING HOLE SPACING

- E - 950 [37.4]
- F - 994 [39.1]

CABLE LENGTH

- L - 1,000 [39.4]

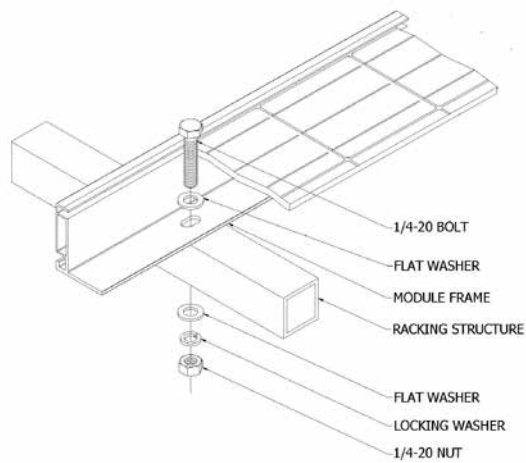
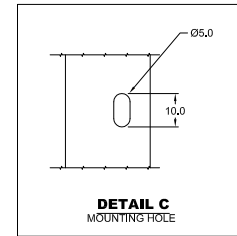
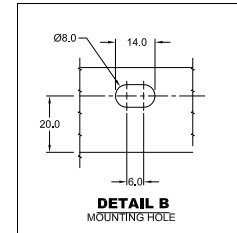
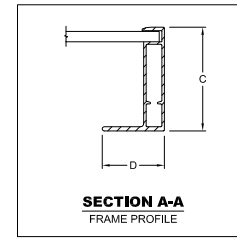
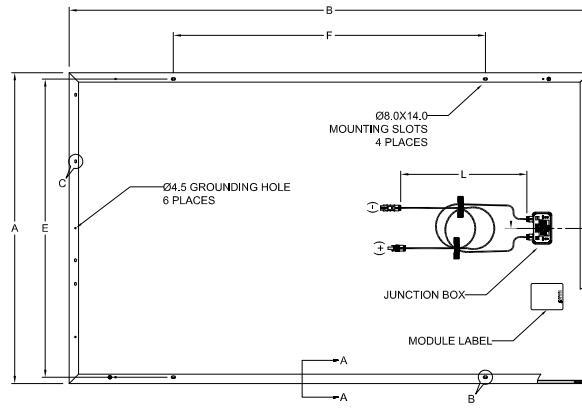

7.2 PHYSICAL PARAMETERS

Module Weight	19.3 kg
Frame Material	Anodized Aluminum
Glass (mm)	3.2 Tempered ARC glass
Connector	S418 BizLink/Amphenol PV Connector

7.3 PRE-MOUNTED CABLES AND CONNECTORS

Mounting Configuration	Pre-mounted cables	Pre-mounted connectors
Type	TUV – PV1-F & UL – PV wire	locking polarized connectors
Cross section	4.0 mm ²	4 mm dia.
Max. current	16 A	25 A
Max. system voltage	1000 VDC/ UL 600 V	1000 VDC/ UL 600 V
Temperature rating	-40°C to +90°C	-40°C to +85°C
Qualification	TUV 2PFG & UL PV wire	EN 50521 & UL for PV sys

For more information about SunEdison Silvantis modules, please visit www.SunEdison.com

© 2013 SunEdison, Inc. All rights reserved. SunEdison and the SunEdison logo are registered trademarks or trademarks of SunEdison, Inc. and/or its affiliates in the United States and certain other countries. All other trademarks mentioned in this document are the property of their respective owners. The use of the word partner does not imply a partnership relationship between SunEdison and any other company.