



Application Specification 114-18488-1

SOLARLOK connecting system for solar panels

Notification:	3
1. Supplementary Documentation	3
1.1 Customer Drawings	3
1.2 Product Specifications	4
1.3 Model Code	4
1.4 Application Specification	4
1.5 Cleaning Products	4
2. SOLARLOK Junction Box	5
2.1 General instructions (Handling, safety and cleanness)	5
2.2 Installation guidelines for junction box attachment to the PV-module	5
2.2.1 Contents	5
2.2.2 Assembly Aids	5
2.2.3 Equipment	6
2.2.4 Supporting products for assembly and safety	6
2.2.5 Safety instructions	6
2.2.6 Final assembly process using single component silicon adhesive	6
2.2.6.1 Preparation	6
2.2.6.2 Adhesive Application Procedure	7
2.3 Wiring the Junction Box	7
2.3.1 Tab Connections	7
2.3.2 Assembling diodes and jumpers	8
2.4 Cable Routing	10
2.5 Direct Cable Attachment to the SOLARLOK Junction Box	10
2.5.1 6-Rail box with pre-assembled cable screw joint	11
2.5.2 Boxes with 3, 4 and 5 rails (3, 4 and 5-Rail Box)	12
2.6 Junction box lid assembly	13
2.6 Junction box lid assembly	14
3. SOLARLOK Connector	16
3.1 General instructions	16
3.2 Termination of the cable wires /crimping of the contacts	16
3.2.1 Handling of connectors and cables	17
3.2.2 Assembly and Connection of Wire Leads	18
3.2.3 Assembly of Connectors	19
3.2.4 Connector Latching	21
3.2.5 Unmating of Connectors	23
3.2.6 DC/AC Converter connector	23
4. Accessories	24
4.1 T - Distributor	24
4.2 Safety Clip	25
4.3 Locking collar	25
4.4 Solar cables released for SOLARLOK Connectors	26
4.5 Protective covers for connectors	27
5. Examples of use	28
6. Storage	28
7. Tools	29

Purpose

This specification contains guidelines for the assembly, installation and fitting of the SOLARLOK connecting boxes, and connection parts to customer solar panels.

For this specification the Connecting boxes are marked as follows:

- 6-rail Box (large)
- 4-rail Box (medium)
- 3-rail Box (small)
- 5-rail Box

Notification:

The application of the Tyco Electronics Solar boxes on the Solar panel as well as the installation of the Solar panel is not part of the scope of services offered by Tyco Electronics. In addition, Tyco Electronics does not offer a warranty for Solar boxes with integrated solar cable assemblies if those cable assemblies will be exchanged or unfixed after delivery from Tyco Electronics. A cable extension has to be made at the coupling end of the cable (plug connector) and only with Tyco Electronics components. If single connectors or solar junction boxes without attached cable are delivered by Tyco Electronics, the mounting of the cable is also not in the scope of services offered by Tyco Electronics. This is also the case for subsequent mounting of diodes or jumpers. The assembly location and assembly procedure have to agree with JEDEC standard JESD22-114F.

1. Supplementary Documentation

1.1 Customer Drawings

	Solar Module Box, Assy / 6-rail Box
	Solar Module Box, Assy / 5-rail Box
	Solar Module Box, Assy / 4-rail Box SOLARLOK RGG 4-4 SOLARLOK R RP 4/4 SOLARLOK 4 Stromschienen
	Solar Module Box, Assy / 3-rail Box
PN 1394461	<i>Photovoltaic Connector Pin 1 pos.</i>
PN 1394462	<i>Photovoltaic Connector Socket 1 pos.</i>
PN 1394738	<i>Converter Connector 1 pos.</i>
PN 1740210	<i>Converter Connector 1 pos. (flat seal and plastic nut)</i>
PN 1534226	<i>Safety Clip</i>
PN 2106207	<i>Locking Collar</i>
PN 1718077	<i>Label</i>
PN 1534611, PN 1740277	<i>T-Distributor</i>
PN 1740724	<i>Adhesive Foil 4-rail Box (1.3mm)</i>
PN 2120156	<i>Adhesive Foil 4-rail Box (3mm)</i>
PN 1740214	<i>Adhesive Foil 3-rail Box (on request)</i>
PN 1987752	<i>Adhesive Foil 5-rail Box (on request)</i>
PN 1987697	<i>Adhesive Foil ECO Box (on request)</i>
PN 1534610	<i>Adhesive Pad round for 6-rail Box</i>
PN 1740620	<i>Adhesive Pad square for 6-rail Box</i>

It is necessary to find the dimensions, materials and surfaces in the relevant customer drawing.

1.2 Product Specifications

It is always necessary to take into consideration the specification of the components being used.

Large box and Connector	108-18701 SOLARLOK
5 Rail Solarbox	108-94156 SOLARLOK
Medium Solarbox	108-94064 SOLARLOK
Medium Solarbox	108-94038 SOLARLOK
Small Solarbox	108-18955 SOLARLOK

1.3 Model Code

The side-printed model code on the box describes the configuration of the box as well as components used. For this specification the Connecting boxes are marked as follows according spec 404-74000-1:

- 6-rail Box (large) with model code starting LARBO
- 4-rail Box (medium) with model code starting with MEDOT, MEDIN or MEDOM
- 3-rail Box (small) with model code starting with SMALL
- 5-rail Box with model code starting with 5RAIL

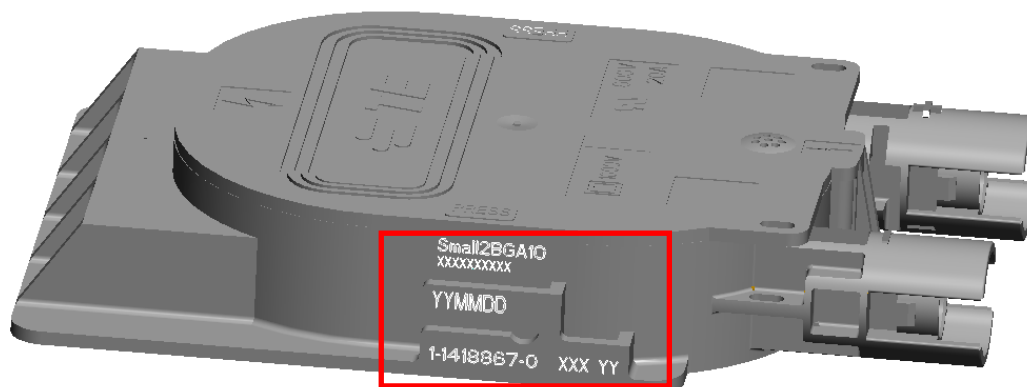

The connection box shown with Model Code

1.4 Application Specification

The Application specification for the SOLARLOK contacts is 114-94061.

For larger package units, the instruction sheet 411-18305 is included as a manual for assembly.

1.5 Cleaning Products

Cleaning products which can erode the plastics (connector and Junction Box) must not be used. We recommend the use of soft cloths moistened with Isopropyl alcohol for cleaning.

You must not use oils or lubricants of any type or other materials that are not stated in this specification.

2. SOLARLOK Junction Box

2.1 General instructions (Handling, safety and cleanness)

Any type of exposure to contaminants (dust, humidity etc.) can negatively affect the system with regards to its functions, over the duration of use. This applies especially to the functionality of the connector seals and crimped contact connections. Therefore, during assembly, it is necessary to ensure a careful and clean processing environment.



During storage, transportation and installation, it is necessary to protect the non-inserted contacts against contamination from dust or moisture. Connectors should be protected with the appropriate recommended dust caps* prior to being fully connected.

* Suitable protective covers are available for connectors (see 4.3).

2.2 Installation guidelines for junction box attachment to the PV-module.

The following application technical instructions are made as guidelines. These instructions do not excuse the user or installer of the SOLARLOK boxes from independently testing the adhesive tapes or silicone glues to determine the suitability for their proposed assembly process and application.

2.2.1 Contents

This section describes the gluing of various SOLARLOK connecting boxes onto the rear side of the solar modules with the goal to secure the product in accordance with this specification. This technique may be used on either glass panels or glass/Tedlar panels.

2.2.2 Assembly Aids

Only adhesives approved by Tyco Electronics can be used. Adhesive materials other than those stated under 2.2.2.1 must be independently tested and verified by the customer at their own responsibility.

2.2.2.1 Single component silicon adhesive

- Dow Corning Type 895, black, for the rear glass side
- Dow Corning Type 744, white, for the rear side of the foil
- Dow Corning Solar PV 804, neutral adhesive (see Dow Corning data sheet regarding the suitability for the material of the rear side of the panel)
- Base coat (primer) (optional), for example, General Electric SS 4179

2.2.2.2 Adhesive foil

- Double-sided adhesive foils (see paragraph 1.): apply per the valid material manufacturer's instructions for processing.
- The customer should independently test and verify the suitability of using adhesive foils on panel surfaces that are not entirely flat.

2.2.3 Equipment

The recommended adhesive is typically provided in cartridges. Refer to supplier's application instructions for adhesive applicator and application.

2.2.4 Supporting products for assembly and safety

- Guns for spraying from the cartridge
- Gloves, soft and clean cloths
- Cleaning product isopropyl alcohol
- Spatula, brush
- Weight, for example a piece of metal with an approximate weight of 1kg

2.2.5 Safety instructions

Before beginning the junction box attachment process, obtain, review and follow the manufacturer's material safety information.



The use of appropriate gloves and eye protection is required throughout the attachment process. Ensure adequate ventilation at all times during the attachment process. Refrain from eating, drinking or smoking in the vicinity. Do Not expose to open flames.

When working with silicone adhesive:

- Avoid contact with eyes. If eye contact occurs, rinse for a period of 15 minutes and seek medical help.
- Avoid prolonged contact with skin.

2.2.6 Final assembly process using single component silicon adhesive

2.2.6.1 Preparation

Place the photovoltaic panel face down on the work table. The attachment area of the photovoltaic panel must be dry, oil-/fat-free and free of any dust, oil and contaminants. Thoroughly clean the attachment area with a clean, lightly moistened Isopropyl alcohol soft cloth (e.g. moistened using a dosing unit). Further auxiliary or other cleaning agents are not permitted. Use of any other cleaning agents has to be specified and tested by the customer. The attachment area must be free from condensation and moisture.

To improve adherence, junction boxes may be treated with primer. The attachment area should be thoroughly covered with primer by using a small spatula brush. The specification from the supplier of the primer has to be followed.

Bend the photovoltaic panel foil tabs so that they extend perpendicular from the plane of the panel.

2.2.6.2 Adhesive Application Procedure

The silicon adhesive needs only to be applied to a small peripheral area on the bottom of the junction box. Before applying the adhesive, it is recommended that the junction box cover be opened to ease later attachment to the photovoltaic panel. A 10 mm – 20 mm wide band of adhesive applied to the recess area is adequate. During this process, ensure that the silicon bead is continuous and free of gaps. If desired, the silicon bead may be smoothed with the small spatula to ensure a uniform and gap free surface.



Touching or handling of the diodes or the bridging elements during the pressing of the box is not permitted. Mechanical stressing of diodes or bridging elements can cause their destruction and thereby the malfunction of the panel.

To attach the junction box to the photovoltaic panel, thread the foil tabs through the openings in the bottom of the junction box. Make sure the junction box is properly oriented in a horizontal position before firmly placing the junction box into its final position on the photovoltaic panel. At this point, the 1kg metal weight can be applied to the top of the junction box to ensure adequate adhesive coverage.

If desired, use the spatula to smooth any excess silicon that may have extruded out of the joint. Using a clean cloth, remove any excess adhesive drips that may have occurred during assembly. Keep the photovoltaic module assembly in the horizontal position until full cure is obtained.

A full cure requires 20 hours at room temperature before the photovoltaic module can be connected and tested

2.3 Wiring the Junction Box

2.3.1 Tab Connections

The tabs exiting the photovoltaic panel are terminated to the tab connectors as shown in **figure 1 & 2** below:

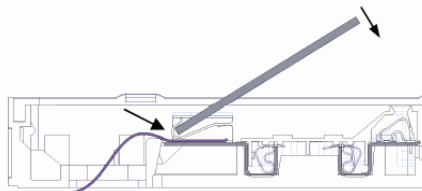

Fig.1 (6-rail Box)

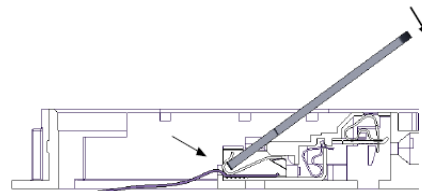

Fig.2 (4-rail Box)

Using a Tyco Electronics opening tool, lever the spring clamp until it is open to allow tab insertion. The width of the tab cannot exceed 8 mm. If the tab exceeds this width, it can be folded over onto itself to reduce the width so long as the maximum thickness does not exceed 1.5 mm.

For 6-rail boxes with additional breathable membrane, a tool with revision B1 or higher must be used. Use of older tool revisions may cause damage to the membrane.

All terminal blocks can be opened at once using the following tools:

Box	Tool
6-rail Box	0-1579007-3
5-rail Box	0-1740969-3
4-rail Box	0-1740969-1
3-rail Box	0-1740969-2

Table 1

2.3.2 Assembling diodes and jumpers



When replacing a diode, the marking of the new diode (including the letter) must exactly correspond with the existing installed diode.

The Tyco Electronics SOLARLOK Junction Box offers the user a number of jumper and interconnection options. By utilizing various combinations of jumpers and diodes, a number of photovoltaic panel configurations can be realized. Termination of jumpers and diodes is accomplished by inserting the component leads into the spring clip openings of each rail. The maximum opening of these clips is 2.5mm x 2.1mm. The use of solid leads is required.

Recommended diode and jumper dimensions:

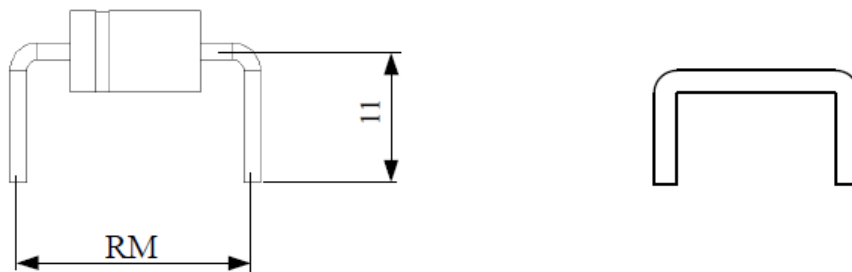

Fig. 3

Recommended bend locations for various jumper positions shown in the Table 2 and figure 4:

Table 2 Contact Spacing

RM_1	RM_2	RM_3	RM_4
20.8 mm	17.8 mm	42.8 mm	45.8 mm

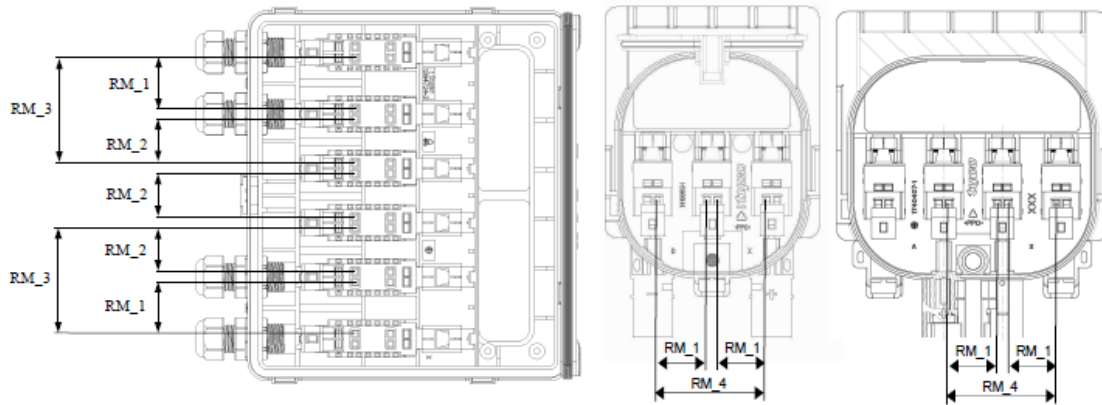
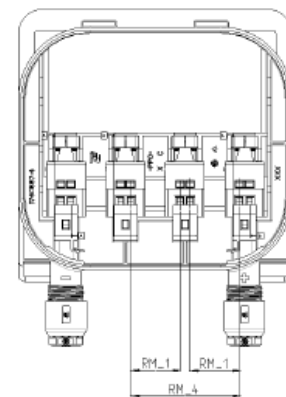

Figure 4



To terminate the diodes or jumpers, a Tyco Electronics tool is inserted vertically down to open a window in the spring clip, as shown in figure 5 and 6. The diode or jumper lead is inserted into the open spring clip window. Removal of the tool will allow the clip to close and terminate the lead. The spring clips can be opened in pairs by using a special assembly aid tool PN 0-1579007-5, which can be obtained from Tyco Electronics.

Make sure diodes and jumpers are fully inserted into the clips as deeply as possible in order to avoid direct contact with the lid.

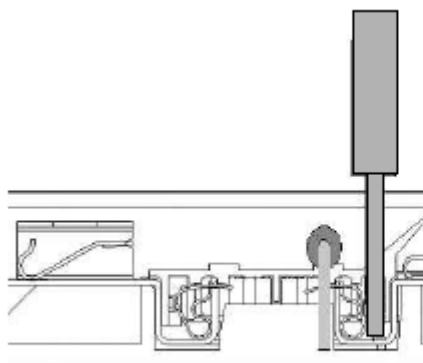

Fig. 5

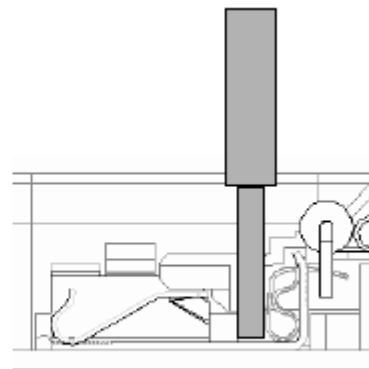
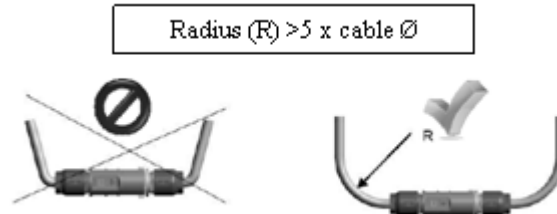

Fig. 6

2.4 Cable Routing

The cable must not be bent or crushed on the direct exit of the cable screw joint. A minimum bending radius $R \geq 5 \times$ cable \varnothing must be maintained. The cable must be routed in a way that tensile stress on the conductor or connections is prevented.



2.5 Direct Cable Attachment to the SOLARLOK Junction Box



In order to ensure protection against electrical shock, the junction box *MUST* be disconnected from all external power sources while installing the cables! *DO NOT CONNECT UNDER ELECTRICAL LOAD!*



In case of replacement of cables or components or of assembling / disassembling of the cable entry gland, new pinch rings and seals have to be used. If a visible deformation appears at the clamping area of the cable, the cable end needs to be trimmed to remove the deformed area.

A direct cable connection can be made to the direct connect junction box using (max. 4mm²) the cable termination spring clips in the junction box. In the manner shown below, direct connection of cable sizes AWG 14 and AWG 12 can be accommodated. The sealing grommet in the 6 rail assembly can accommodate insulation diameters up to 7.0 mm accordingly 3-rail, 4-rail, and 5-rail boxes up to 7.8 mm.

Use only wires released by Tyco Electronics as detailed in Table 7, Section 4.4. To ensure proper termination, cable insulation should be stripped detailed as shown in Figure 7 and Table 3.



Fig. 7

Table 3

X	Box	x-PN-y
11mm±1mm	6-rail Box	all
11mm±1mm	5-rail Box	all
11mm±1mm	4-rail Box	1740657, 1987304
14mm±1mm	4-rail Box	1740699, 1740971, 1971482, 1986175, 1987002, 1987141, 1987458, 1987512, 1987625, 1987883, 1987906, 1987994, 1987995
11mm±1mm	3-rail Box all	all

2.5.1 6-Rail box with pre-assembled cable screw joint

The assembled cable screw joint is suitable for cables with ISO-OD from 5 to 7mm. Replace the seal for cables with ISO-ID smaller than 5mm (seal for cables smaller than 5mm: PN 1987722-1, see fig. 9).

On multi-stranded conductors, it is recommended to use conductor sleeves (for metrical cable/dual rated UL crimping tool PN 734641-2; conductor sleeves for 2.5mm², 4mm² acc. DIN 46228/1 for non-insulated ferrules) or at least, twist the strand bundle to ensure all strands are captured in the spring clip. To open the spring clip window for the cable, a special tool, PN 0-1579007-2, is inserted vertically into the window as seen in **Figure 8**. The cable can be inserted through the opened window into the clip. The release of the spring terminates the cable as shown in **Figure 9**.

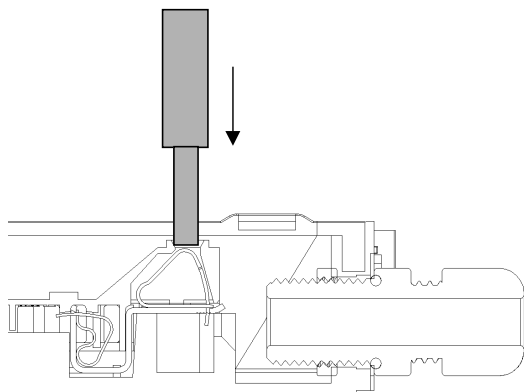

Fig. 8

After termination, tighten the grommet nut to compress the grommet around the cable. Hold the cable screw joint with the torque tool. For this it is recommended to use a slotted socket wrench with wrench size of 15 mm.

The Initial tightening torque is 1,3^{+0.2} Nm.

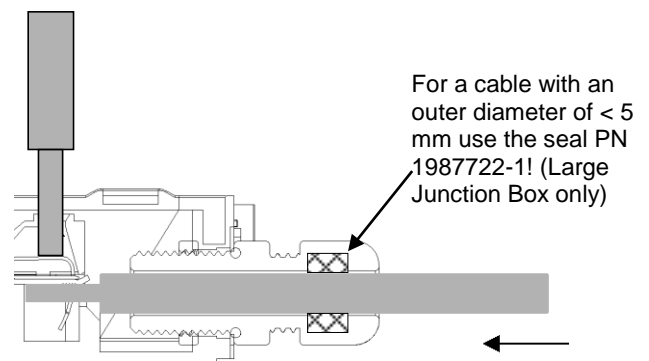

Fig. 9



In case of replacement of cables or components or of assembling / disassembling of the cable entry gland, new pinch rings and seals have to be used. If a visible deformation appears at the clamping area of the cable, the cable end needs to be trimmed to remove the deformed area.

2.5.2 Boxes with 3, 4 and 5 rails (3, 4 and 5-Rail Box)

On multi-stranded conductors, it is recommended to use conductor sleeves (for metrical cable/dual rated UL crimping tool PN 734641-2; conductor sleeves for 2.5mm², 4mm² acc. DIN 46228/1 for non-insulated ferrules) or at least, twist the strand bundle to ensure all strands are captured in the spring clip. To open the spring clip window for the cable, a special tool, PN 0-1579007-2, is inserted vertically into the window as seen in Figure 8. The cable can be inserted through the opened window into the clip. The release of the spring terminates the cable as shown in **Figure 10 and 11**.

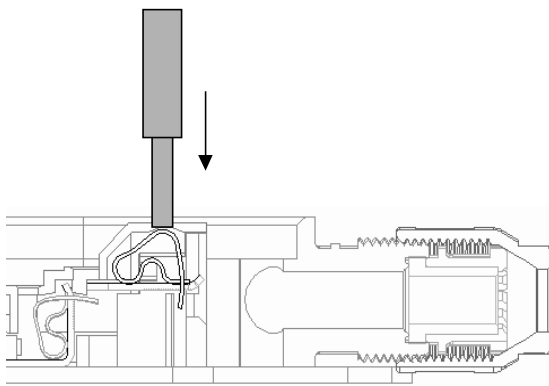

Fig. 10

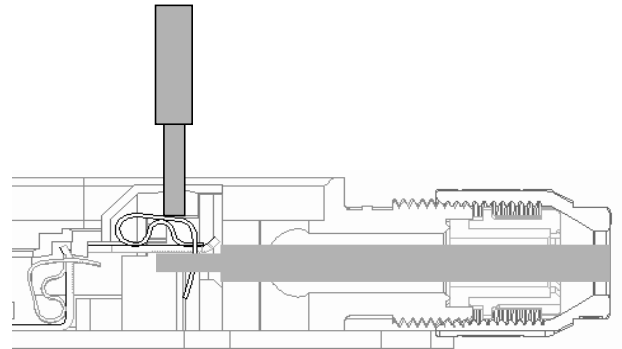
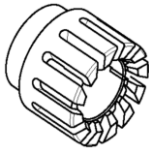



Fig. 11

The Connecting boxes, with integrated couplings for cables, are designed for cable diameters from 4.5 mm to 7.8 mm. In relation to the outer diameter of the cable, a suitable pinch ring must be selected from Table 4.

Table 4

Outer diameter of cable	Pinch ring type
Outer diameter of cable from 5.5 mm to 7.8 mm	1987981-2 
Outer diameter of cable from 4.5 mm to 5.5 mm	1740379-2 

The initial tightening torque is $1.3^{+0.2}$ Nm. For this, it is recommended to use a slotted socket wrench with wrench size of 13mm.



In case of replacement of cables or components or of assembling / disassembling of the cable entry gland, new pinch rings and seals have to be used. If a visible deformation appears at the clamping area of the cable, the cable end needs to be trimmed to remove the deformed area.

The proper contacting of the cable by the spring clamp can be controlled via windows in the bottom of the box (see figure 12) or by measuring the depth of the visible spring clamp in the actuation window (see figure 13). Because of the multitude of applicable cable types and cross-sections, a defined height of the actuated spring clamp can not be determined and has to be defined by the customer.



Figure 12

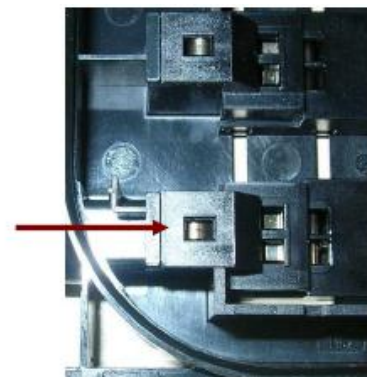

Figure 13

2.6 Junction box lid assembly

Closing the 6-Rail Box: The SOLARLOK connecting box is closed by pressing the lid into the casing. During this procedure, it is necessary to pay attention that the seal is evenly pressed into the bottom part of the casing around the perimeter!

Closing the 5-Rail, 4-Rail und 3-Rail Box: For this type of connecting boxes, the rear part of the lid is hung onto the casing and is closed, together with the bottom part of the lid, by clicking closed the front side. During this procedure, it is necessary to pay attention that the cover is evenly seated on the bottom part of the casing around the perimeter and that the seal properly placed in the area designated for it. For this purpose, the lid must be pressed in over the entire perimeter.



Attention: The junction box should only be opened by authorized and trained personnel!

Opening the 6-Rail Box: Using a screwdriver with the tip width of 3 - 5 mm, the lid must be evenly and carefully lifted up at the marked openings over the entire perimeter and not be pulled up at once!

Opening the 5-Rail, 4-Rail and 3-Rail Box: A screwdriver with the tip width of 3 - 5 mm is inserted into the pocket by of the front part of the lid. By prying, the lid at the latch hook is released and it can be opened by lifting it up.

The lid seal must be uniform all around, and pressed into the circumferential groove of the lid and inserted in the existing fastening lugs (**see figure 14; 15**). After mounting, the seal must not be sitting out from the box housing (**see figure 16**).

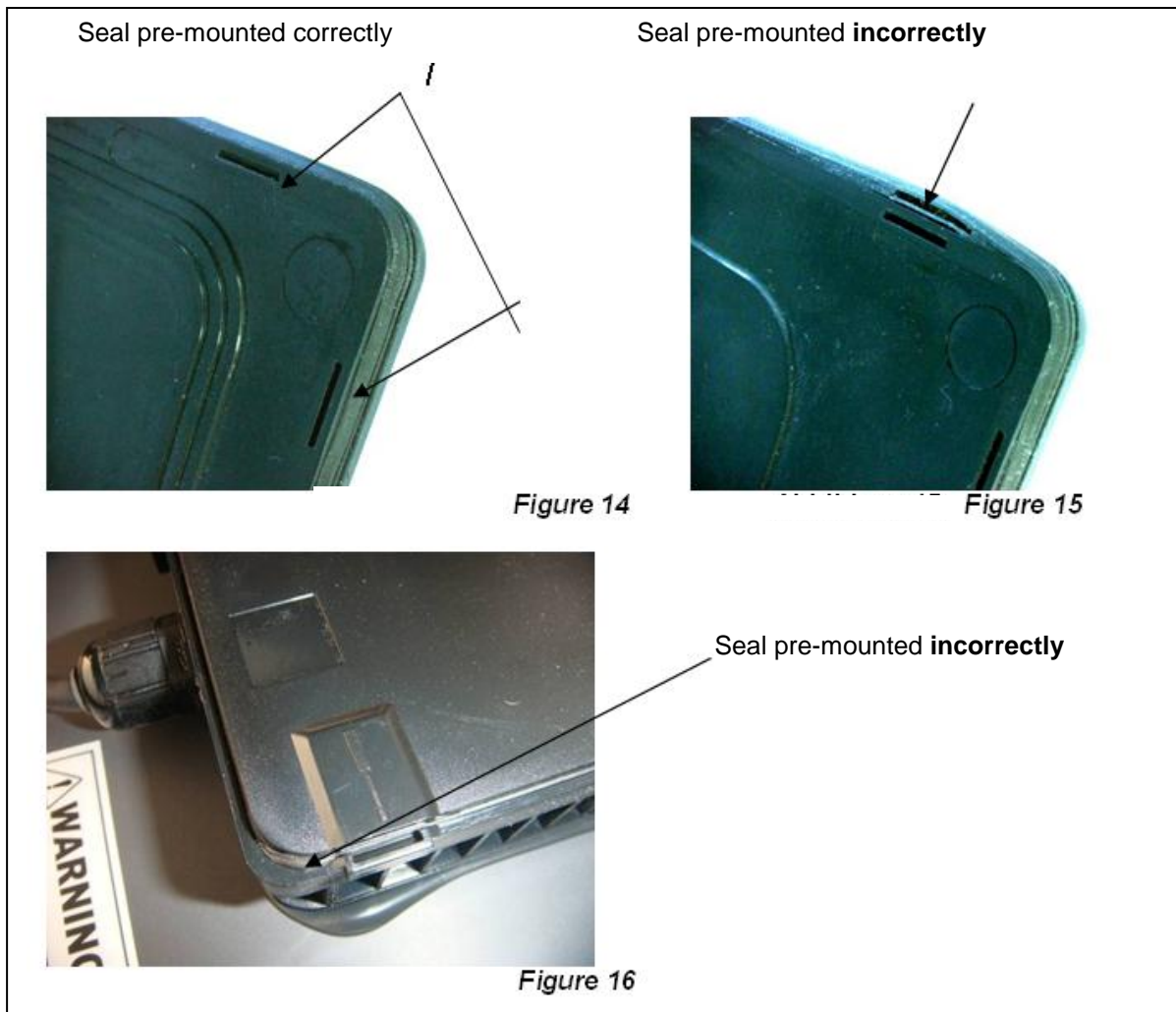

CAUTION: Do not open the junction box while it is under an electrical load. Components within the junction box may be electrically charged and capable of inflicting severe injury or death. Extreme caution should be applied when opening the junction box.

CAUTION: ENSURING OF THE JUNCTION BOX LID – TIGHTNESS
To guarantee tightness, make sure the seal is correctly fitted.

For protection against injury by electrical current, the box and the connector must always be completely separated from other sources of voltage during the prefabricating and cannot be connected or disconnected under voltage. All the openings in the casing must be entirely closed.



Unplugged terminal points must be protected against moisture, dust and any environmental pollution. Only clean and dry plugged terminal points fulfill their respective pollution class. (Dust covers are available, see 4.5)



Attention: If a cable or diode has been pulled out of the spring clamp by force, the box has to be replaced.

3. SOLARLOK Connector



Attention: Do not disconnect under load!

Current path should only be disconnected using approved devices.

Cable assemblies should be labeled with label PN 0-1718077-1.

Always ensure that conductors and their associated connectors are connected to their correct polarity.



Unplugged terminal points must be protected against moisture, dust and any environmental pollution. Only clean and dry plugged terminal points fulfill their respective pollution class. (Dust covers are available, see 4.5)

3.1 General instructions

Any kind of pollution (dust, humidity, etc.) during the assembly process can degrade the contact and connector performance. This applies in particular to the seals and the crimping of the contacts. A clean assembly environment is therefore essential.

Prior to installation, unconnected connectors must always be protected from pollution (e.g. dust, humidity, foreign particles, etc.).



Do Not leave unconnected (unprotected) connectors exposed to the environment
(Dust covers are available, see 4.5)

3.2 Termination of the cable wires /crimping of the contacts

For the SOLARLOK connectors, there are various round contacts used for various wire gauge sizes. It is necessary to use the proper tool adapter for the wire gauge size. These instructions, as well as the necessary information regarding the length of the stripping and preparing crimping connections can be found in the processing specification 114-94061.

The possible connectable wire gauge sizes are 2.5 mm², 4.0 mm², 6.0 mm² or AWG 14, AWG 12 and AWG 10.



In case of replacement of cables or components or of assembling / disassembling of the cable entry gland, new pinch rings and seals have to be used. If a visible deformation appears at the clamping area of the cable, the cable end needs to be trimmed to remove the deformed area.

3.2.1 Handling of connectors and cables



The cable must not be bent or crushed on the direct exit of the cable screw joint.

A minimum bending radius $R \geq 5 \times$ cable diameter must be maintained. The cable must be routed in a way that the tensile stress on the conductor or connections is prevented, (see figures 17 and 18).

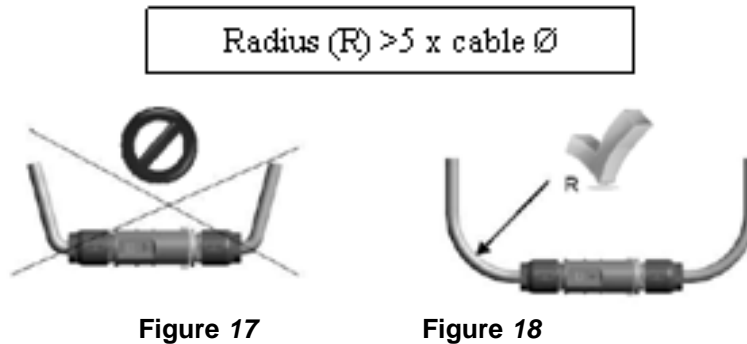

Unplugged terminal points must be protected against moisture, dust and any environmental pollution. Only clean and dry plugged terminal points fulfill their respective pollution class. (Dust covers are available, see 4.5)

3.2.2 Assembly and Connection of Wire Leads



Any type of contaminants (dust, humidity etc.) negatively affects the function and the system's life expectancy and use. This applies especially to the seals and crimped contact connections. Therefore, during assembly, it is necessary to ensure careful and clean processing.

For the SOLARLOK connectors, there are various round contacts used for various wire gauge sizes. **It is necessary to use the proper tool adapter for the wire gauge size.** These instructions, as well as the necessary information regarding the length of the stripping and preparing crimping connections can be found in the processing specification 114-94061.

The possible connectable wire gauge sizes are 2.5 mm², 4.0 mm², 6.0 mm² or AWG 14, AWG 12 and AWG 10. Suitable contacts for individual cable wire gauge sizes can be selected according to table 5:

Table 5

Usable crimping contacts for SOLARLOK connectors			
Lead cross-section	Connector contact (part number)	Part number for connector contact	Tool for crimping connections
2.5 mm ² /14 AWG	1987280-1	1987281-1	HVT 2.5 mm ² / HVT 14 AWG
4 mm ² /12 AWG	1987280-2	1987281-2	HVT 4 mm ² / HVT 12 AWG
6.0 mm ² /10 AWG	1987280-4	1987281-3	HVT 6 mm ² / HVT 10 AWG



For the SOLARLOK components, it is only permissible to use components which are released by Tyco Electronics (See table 7 in paragraph 4.4.).

The assembly of the connector must be performed in the following order:

1. Stripping of the lead (see specification of use 114-94061).

Using the appropriate wire stripping tool, strip the wire **9 mm ± 1 mm** without damaging the strands.



Fig. 19

2. Making a crimping contact connection with suitable Tool-cross-section opening.

Insert the stripped wire into the wire crimp barrel until it stops.

Insert the contact with the cable into the crimp locator until it stops.

While holding the wire in place, squeeze the tool handles together until ratchet releases.



Fig. 20

Detailed information regarding the making of the crimping connections of the contacts SOLARLOK can be found in the specification of use 114-94061.

3.2.3 Assembly of Connectors

Selection of a suitable connector components

The SOLARLOK connectors are available as complete assembly kits that contain all the necessary individual parts. A list of assembly kits can be found in table 6, based on the wire gauge size the connector polarity and the outside diameter of the cable, the correct connector kit can be chosen.



For the SOLARLOK connectors, it is only permissible to use components which are released by Tyco Electronics (See table 7 in paragraph 4.4.).

Table 6

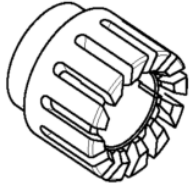
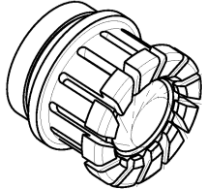
Available Connector Kits for SOLARLOK Interconnection System					
Wire Gauges	Polarity	Male Part Number	Female Part Number	Outside Cable Diameter	Pinch Ring type
2.5 mm ²	+	0-1394461-1	0-1394462-1	Cable Diameter (Outside) from 5.5mm up to 7.8mm	1987981-2 
2.5 mm ²	-	0-1394461-2	0-1394462-2		
2.5 mm ²	N	6-1394461-1	-		
4.0 mm ²	+	0-1394461-3	0-1394462-3		
4.0 mm ²	-	0-1394461-4	0-1394462-4		
4.0 mm ²	N	6-1394461-2	-		
6.0 mm ²	+	6-1394461-5	5-1394462-5		
6.0 mm ²	-	6-1394461-6	5-1394462-6		
6.0 mm ²	N	6-1394461-4	-		
2.5 mm ²	+	0-1394461-7	4-1394462-6	Cable Diameter (Outside) from 4.5mm up to 5.5mm	1740379-2 
2.5 mm ²	-	0-1394461-8	4-1394462-7		
2.5 mm ²	N	6-1394461-3	-		
4.0 mm ²	+	7-1394461-0	4-1394462-8		
4.0 mm ²	-	7-1394461-1	4-1394462-9		
4.0 mm ²	N	7-1394461-2	-		

The assembly of the connectors must be performed in the following order:



Points 1 – 2 do not apply for *prefabricated connectors* in this case the terminated cable has to be inserted directly into the correct *preassembled connector housing*, (see fig. 24).

1. The engagement of the pinch ring into the connector housing (see fig. 21 and 22).

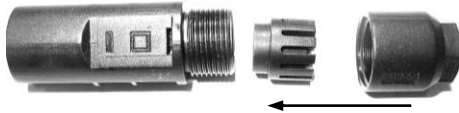

Fig. 21 Connector housing components



Fig. 22 Preassembled pinch ring

2. Connect the locking nut on to the connector housing (only a few turns).



Fig. 23 Prepared connector housing

3. Insert the contacts until an audible click sound is heard and then give a slight pull back (a maximum of 5-10 N force) to check whether the contact has clicked into place.
 - a. The terminal engagement Force is max 25 N.
 - b. The connector housing can be reassembled a maximum of 1 times.
 - c. The contact can be reassembled a maximum of 1 times.

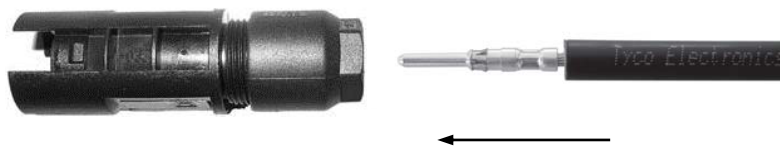

Fig. 24 Final assembly: Insertion of contact with crimped connection

- 4 Use a slotted torque wrench (PN 523229-1) to tighten the cable screw nut (see fig. 25).

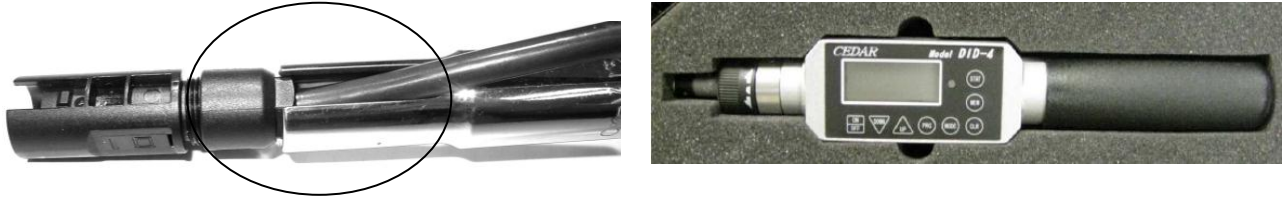

Fig. 25 Tightening of the cable screw lock (Initial tightening torque is max. $1.3^{+0.2}$ Nm).



In case of replacement of cables or components or of assembling / disassembling of the cable entry gland, new pinch rings and seals have to be used. If a visible deformation appears at the clamping area of the cable, the cable end needs to be trimmed to remove the deformed area.

- 5 Label the connector with the connector warning label “Do not disconnect under load!”



Fig. 26 Placement of a warning label

PN 1718077



Unplugged terminal points must be protected against moisture, dust and any environmental pollution. Only clean and dry plugged terminal points fulfill their respective pollution class. (Dust covers are available, see 4.5)

3.2.4 Connector Latching

When mating the SOLARLOK connectors, ensure the following:

- Connectors labeled with a + or – are keyed and can only be mated to similarly marked and keyed connectors.



Caution: The “neutral” designated pin-connectors does not incorporate keying features and may be freely mated to either + or – keyed female-connectors. The neutral product should not be used where maintaining polarity is critical. It is only applicable for serial connections.

- With the “neutral version”, it is necessary to mark the connector polarity using the labels (PN 1394725-1 or -2). The sticker must be placed on the lead and near the connector.
- Mating of the connectors is done by pushing the connectors together until a clear audible click is heard. This clear audible clicking sound must be heard to ensure the connectors have been mated correctly. When the connectors are correctly connected the latches should be flush against the edge of the connector (see fig. 27 - 29).
- Note: The engagement force to engage the connectors is 30 N max.

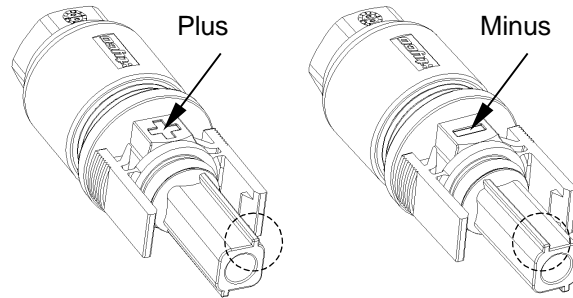

Figure 27 (Female Connector)

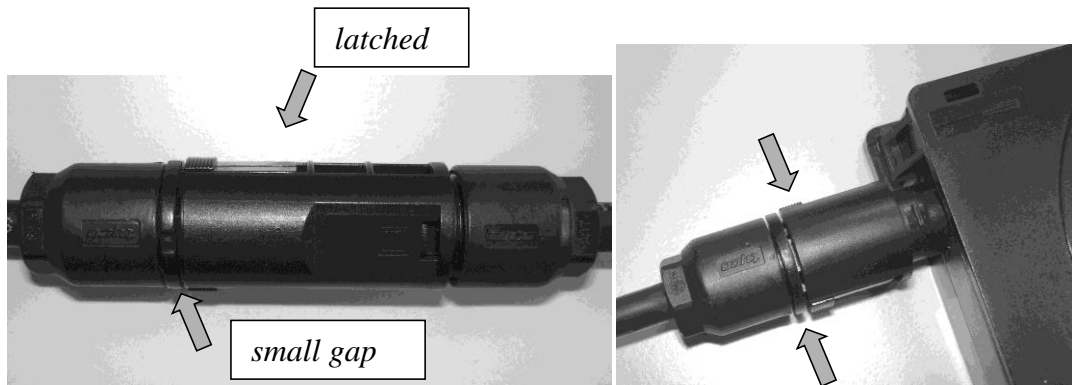

Figure 28 (correct latching)

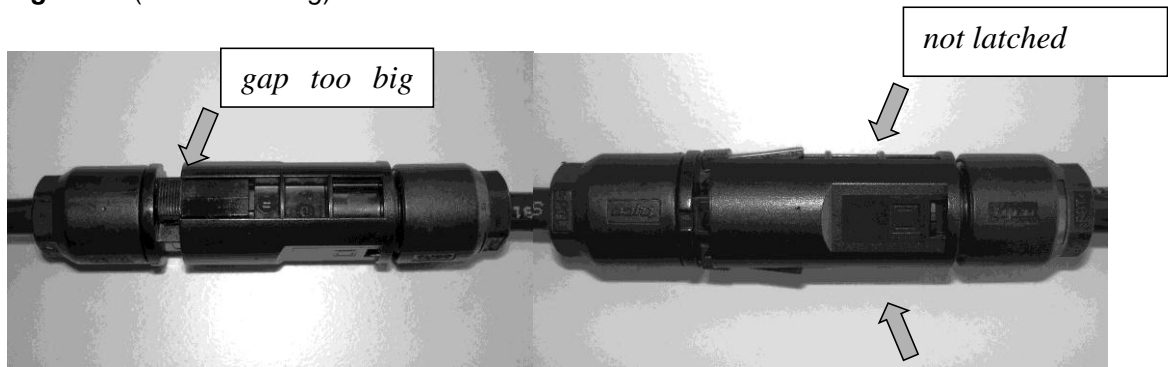

Figure 29 (incorrect latching)

3.2.5 Unmating of Connectors



ATTENTION: Do not disconnect the connector under electrical load!
Disconnect circuit from electrical load before unplugging connectors.
Cable assemblies should be labeled using Tyco Electronics Label PN 0-1718077-1.

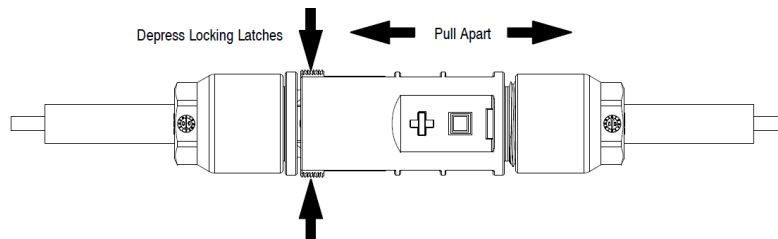

Fig. 30 Disconnecting the connector

1. The locking mechanism is opened by depressing the latches as shown in Figure 30.
2. Disconnect the connector connection by pressing the latches together and pull both parts apart.

3.2.6 DC/AC Converter connector

1. Place a single wire seal onto the wire and strip wire (see application specification 114-94061)
(Note: single wire seals are not available with every version).

Fig. 31



2. Crimp the contact using the correct applicator for the wire gauge.

Fig. 32

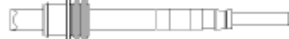

3. Place O-ring (or Flat Seal PN 1740067) onto the connector housing, push in the wire until it stops and the contact locks into the housing.

Fig. 33



4. Insert the seal into the housing.

Fig. 34

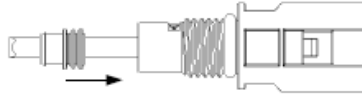

5. Assembly of the cover (optional) and assembly into a front panel.

Fig. 35

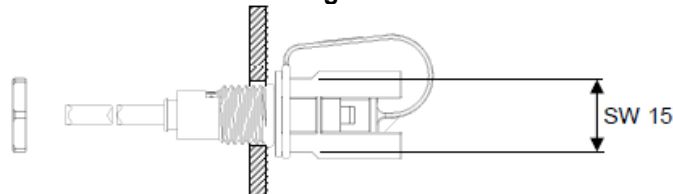

- Required panel mount hole diameter: $\varnothing 12,3_{+0,2}$ mm.
- The panel thickness must be at least 1 mm up to 4mm.
- For environmental protection of the unmated connector, use of the covering cap is recommended.
- Cover PN 0-1394739-1.
- Torque for mounting nut $1,3_{+0,2}$ Nm with the O-ring, $1,0_{+0,2}$ Nm with the flat seal.

4. Accessories

4.1 T - Distributor

The T-Distributor is for connecting a parallel circuit or coupling. It is used to ensure that the maximum overall current is not exceeded. The T-Distributor must always be completely connected, (See figure 36).

Fig. 36

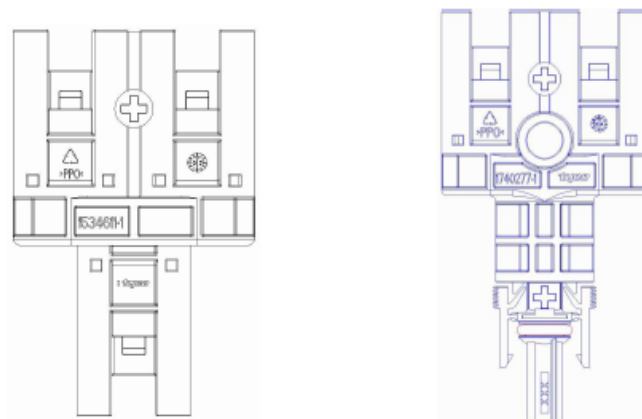



ATTENTION: Do not disconnect the connector under electrical load!

Disconnect circuit from load before unplugging connectors. Cable assemblies should be labeled using Tyco Electronics Label 0-1718077-1.

4.2 Safety Clip

Safety sleeve (PN 1534226) can be additionally mounted on all variations of housings for pin connectors. It serves as additional securing of the connector. In order to open, insert the screwdriver under the marked area and move in an upward direction.

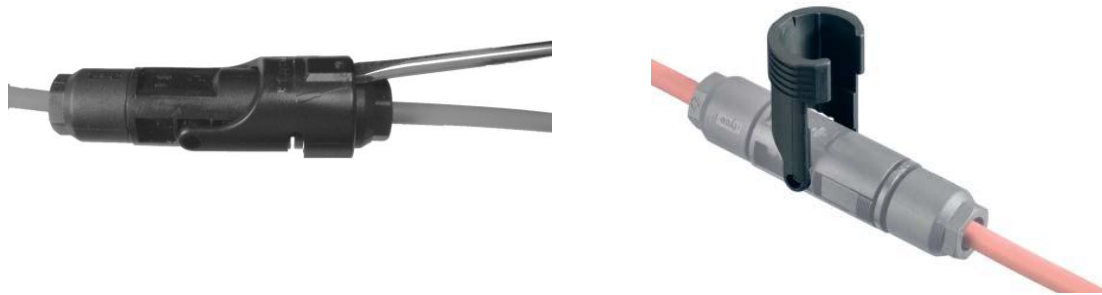

Fig. 37a

The connecting of the safety sleeve is performed by a simple latching onto the opposite mounted connector.

4.3 Locking collar

For the use of the locking collar (PN 2106207-1) refer to the Tyco Electronics Application spec. 114-13239 and the Instruction Sheet 408-10296.

Fig. 37b



4.4 Solar cables released for SOLARLOK Connectors

Table 7

Manufacturer	Description	Wires size
Tyco Electronics SOLARLOK Cable	ZHSCG-35-2.5 PN 956 297-4 PN 956 297-5 PN 956 297-6	2.5 mm ² / AWG14
Tyco Electronics SOLARLOK Cable	ZHSCG-35-4.0 PN 956 298-4 PN 956 298-5 PN 956 298-6	4.0 mm ² / AWG12
Tyco Electronics SOLARLOK Cable	ZHSCGB-35-4.0 PN 1983530-1	4.0 mm ² / AWG12
Tyco Electronics SOLARLOK Cable	ZHSCG-35-6.0	6.0 mm ² / AWG 10
Studerlabel	Solar wire Betaflam 125 PN 1987025-2	2,5 mm ² / AWG 14
Studerlabel	Solar wire Betaflam 125 PN 1987025-1	4.0 mm ² / AWG 12
Studerlabel	Solar wire Betaflam 125 "R" PN 19870905-1	4.0 mm ² / AWG 12
Studerlabel	Solar wire Betaflam 125	6.0 mm ² / AWG 10
Tyco Electronics	Tyco Electronics USE-2 cable PN 1986165-1	AWG 12
HELU Solar	Solarflex PV 1	4.0 mm ²
Huber & Suhner	Radox Smart PN 2120219-1	4.0 mm ² / AWG12

4.5 Protective covers for connectors

These protective dust plugs serve for the protection against environmental contaminants. Their use is not allowed for operation on the panel or connector (protection level IP 44).

Fig. 38



Dustcap PN 1987424-1 for socket connectors



Dustcap PN 1987423-1 for socket connectors (with loss protection)



Protction plug PN 1394739-1 for pin connctors (with loss protection)



Protection plug PN 1987419-1 for pin connectors



Unplugged terminal points must be protected against moisture, dust and any environmental pollution. Only clean and dry plugged terminal points fulfill their respective pollution class.

5. Examples of use

Fig. 39

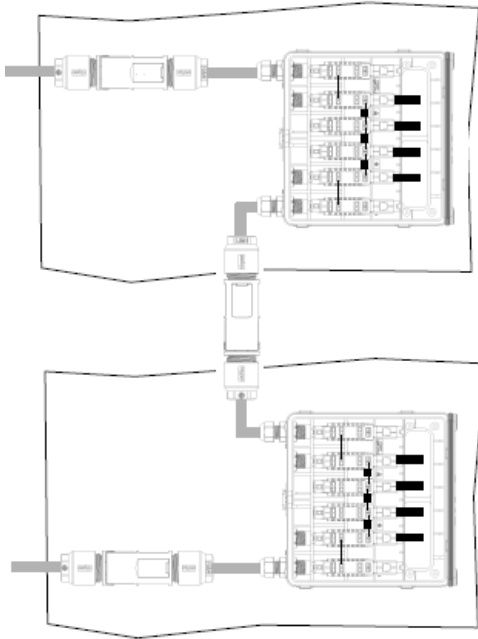

Serial connection with neutral connector with pin distribution in the connecting box using wire bridge

Fig. 40

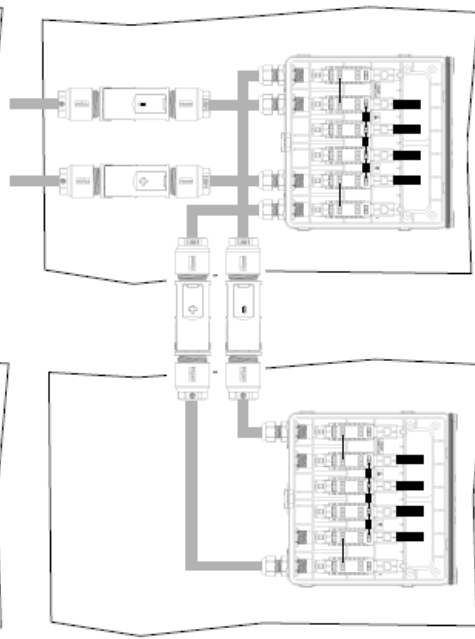

Parallel connection with coded connectors and distribution in the connecting box using wire bridge

6. Storage

See product specification 108-18701, 108-18955, 108-94038 and 108-94064.

7. Tools

- The following tools are available for the contact crimping (please specify required wire gauge): Hand Tool, integral Locator and Die (PN 0-1579004-8 (metric) or PN 0-1579004-9 (AWG)), use 'HVT' position on locator.
- An extraction tool (PN 0-1102855-3) is needed to disassemble the connector components. This tool is used to unlock the contact retention features, after which the contact can be removed and re-used if necessary.
- The contact can then be reassembled again (1 times). The push-out tool is lifted into the cavity from the side of the insertion slot and is placed onto the contact. Next, push on to the push-out tool will release the contact; using the knock out button the contact is pushed out in the direction of the connection.



In case of replacement of cables or components or of assembling / disassembling of the cable entry gland, new pinch rings and seals have to be used. If a visible deformation appears at the clamping area of the cable, the cable end needs to be trimmed to remove the deformed area.

Principle description of the function:

Fig. 41

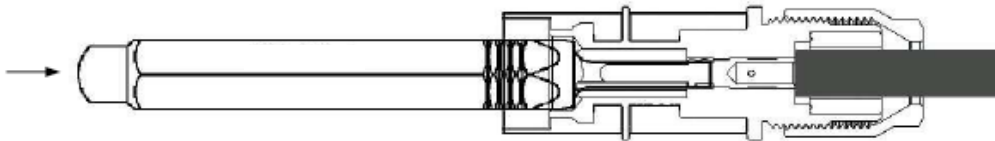

- Insulation stripper: PN 1-1579002-2.
- Connecting tool for connecting the solar cable to the box: tool for opening the clamps PN 0-1579007-2.
- Connecting tool for the diodes PN 0-1579007-5.
- Opening tool for foil springs PN 0-1579007-3.

Fig. 42



- Slotted socket wrench PN 523229-1 for tightening of the clamp nut to a initial tightening torque of $1.3^{+0.2}$ Nm.



In case of replacement of cables or components or of assembling / disassembling of the cable entry gland, new pinch rings and seals have to be used. If a visible deformation appears at the clamping area of the cable, the cable end needs to be trimmed to remove the deformed area.